

 MITSUBISHI MATERIALS

ИНСТРУМЕНТ ДЛЯ СВЕРЛЕНИЯ



DIA  **EDGE**

NEW

MITSUBISHI MATERIALS

ПРЕДСТАВЛЯЕТ НОВЫЙ ОБЩИЙ КАТАЛОГ C009 - 2022/2023

ЦЕЛЕНАПРАВЛЕННЫЙ, КОМПАКТНЫЙ, УДОБНЫЙ.

Широкий ассортимент продукции Mitsubishi Materials теперь показан в каталогах, каждый из которых предназначен для отдельной области применения, предлагая пользователям быстрый и легкий доступ к целевой информации о продуктах.

Комплект состоит из следующих пяти каталогов:

- **ТОКАРНЫЙ ИНСТРУМЕНТ**
- **ИНСТРУМЕНТ ДЛЯ СВЕРЛЕНИЯ**
- **ТВЕРДОСПЛАВНЫЙ МОНОЛИТНЫЙ ФРЕЗЕРНЫЙ ИНСТРУМЕНТ**
- **ФРЕЗЕРНЫЙ ИНСТРУМЕНТ СО СМЕННЫМИ ПЛАСТИНАМИ**
- **MPLUS**

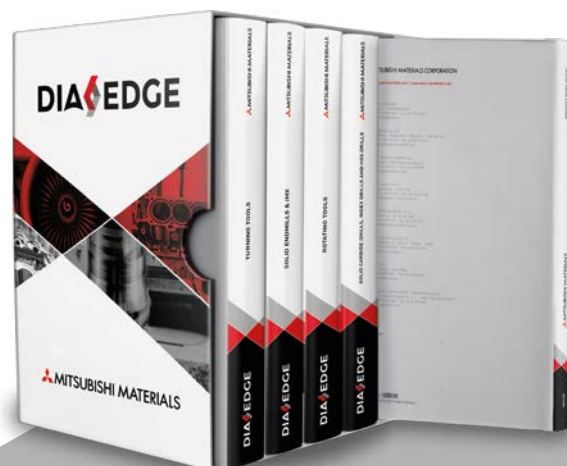

НОВЫЙ ДИЗАЙН

ПРОСТОТА ИСПОЛЬЗОВАНИЯ

ШИРОКИЕ ВОЗМОЖНОСТИ

КЛАССИФИКАЦИЯ ПО ОБЛАСТЯМ ПРИМЕНЕНИЯ

Все каталоги небольшого размера укомплектованы в футляр, который обеспечивает удобство хранения и предлагает необходимое пространство для всех будущих каталогов, включая брошюры, которые будут опубликованы в течение 2-х летнего жизненного цикла каталога. Каждая новая брошюра, опубликованная в течение 2-х летнего цикла, полностью заменит предыдущую версию, поэтому, пожалуйста, удалите старые версии.

ПРИМЕЧАНИЕ:

- с выпуском нового Общего каталога все предыдущие Общие каталоги и брошюры теряют свою актуальность;
- каталоги с новинками продукции выпускаются два раза в год: весной и осенью;
- новый Общий каталог можно получить только в качестве комплекта, состоящего из пяти каталогов.



ЭЛЕКТРОННАЯ ВЕРСИЯ

Чтобы получить электронную версию каталога, отсканируйте QR-код или посетите наш сайт:
www.mhg-mediastore.net

ИНСТРУМЕНТ ДЛЯ СВЕРЛЕНИЯ



НОВЫЕ ПАРАМЕТРЫ ПРОИЗВОДИТЕЛЬНОСТИ

Современная обрабатывающая промышленность быстро развивается, поэтому Mitsubishi стремится идти в ногу с требованиями рынка.

Благодаря постоянному взаимодействию с партнерами и клиентами мы можем предложить решения для задач любой сложности.

От сверла MVX со сменными пластинами для отверстий глубиной до $6 \times D$ до сверла MPS1 для глубоких отверстий — Mitsubishi Materials всегда найдет индивидуальные решения для всех применений.

DIA EDGE

СОЗДАЕМ
ЛУЧШЕЕ БУДУЩЕЕ
ВМЕСТЕ С НАШИМИ
КЛИЕНТАМИ

Представляем DIAEDGE — наш новый товарный знак, который воплощает самые передовые технологии, впечатляющие всех, кто использует их.

Наша цель — не только предлагать высококачественный инструмент, но и тесно взаимодействовать с нашими клиентами, вместе вдохновляться новыми идеями и решать более сложные задачи.



MITSUBISHI MATERIALS

2022/2023

СОДЕРЖАНИЕ

ИНСТРУМЕНТ ДЛЯ СВЕРЛЕНИЯ



ИНСТРУМЕНТ ДЛЯ СВЕРЛЕНИЯ

M001

ЗАПАСНЫЕ ЧАСТИ

N001

ТЕХНИЧЕСКИЕ ДАННЫЕ

P001

ПРЕДМЕТНЫЙ УКАЗАТЕЛЬ

1

ОБЩАЯ ИНФОРМАЦИЯ

КАК ПОЛУЧИТЬ ИНФОРМАЦИЮ О СВЕРЛАХ

● Как пользоваться страницами раздела

① Таблицы сформированы в соответствии с применением сверл.

ИЗОБРАЖЕНИЕ ПРОДУКЦИИ

ОПИСАНИЕ ПРОДУКЦИИ

ТИП ПРОДУКЦИИ

ИНСТРУМЕНТ ДЛЯ СВЕРЛЕНИЯ (МОНОЛИТНЫЕ ТВЕРДОСПЛАВНЫЕ СВЕРЛА)

MPS1

● Типы монолитных твердосплавных сверл по системе ATCON.
 ● Тип MPS1 — универсальный тип сверл для точной и надежной обработки.

Сверлильный сверла с четырьмя режущими кромками

Выгнутые охлаждение

● Тип 1 Цилиндрический тип хвостовика с конической шайбой
 ● Тип 2 Цилиндрический тип хвостовика

● Тип 3 Тип хвостовика Whistle notch с конической шайбой
 ● Тип 4 Тип хвостовика Whistle notch

● Тип 5 Тип хвостовика Whistle notch

DC (mm)	Тип	D1/D2	Обозначение	Размеры (mm)							
				LU	LCF	LH	LF	LF1	PC	PC2/D2	
3.0	3	3	MPS1-0300S-DIN	15.0	19.5	24.5	61.5	61.0	61.0	61.0	61.0
			MPS1-0300S-DIN-C	15.0	19.5	24.5	61.5	61.0	61.0	61.0	61.0
			MPS1-0300L-DIN-C	20.0	24.5	29.5	65.0	65.0	65.0	65.0	65.0
	5	5	MPS1-0300-PC	6.0	16.5	19.7	55.5	55.0	55.0	55.0	55.0
			MPS1-0300-LAC	24.0	33.0	38.0	78.0	78.0	78.0	78.0	78.0
			MPS1-0300-L10C	30.0	37.5	42.5	79.5	79.5	79.5	79.5	79.5
	10	10	MPS1-0300-L12C	39.0	43.0	48.0	85.0	85.0	85.0	85.0	85.0
			MPS1-0300-L14C	45.0	52.0	57.0	84.0	84.0	84.0	84.0	84.0
			MPS1-0300-L20C	60.0	67.0	72.0	109.0	109.0	109.0	109.0	109.0
	15	15	MPS1-0300-L20C	75.0	82.0	87.0	124.0	124.0	124.0	124.0	124.0
			MPS1-0300-L30C	90.0	97.0	102.0	139.0	139.0	139.0	139.0	139.0
			MPS1-0300-L30C	105.0	112.0	117.0	158.0	158.0	158.0	158.0	158.0
	30	30	MPS1-0300S-DIN	150.0	190.0	230.0	170.0	170.0	170.0	170.0	170.0
			MPS1-0300S-DIN-C	15.0	19.0	24.0	61.0	61.0	61.0	61.0	61.0
			MPS1-0300L-DIN-C	20.0	24.0	29.0	65.0	65.0	65.0	65.0	65.0
40	40	MPS1-0300S-DIN	14.0	19.0	24.0	61.0	61.0	61.0	61.0	61.0	
		MPS1-0300L-DIN-C	19.0	24.0	29.0	65.0	65.0	65.0	65.0	65.0	
		MPS1-0300-PC	6.0	16.0	19.0	55.0	55.0	55.0	55.0	55.0	
10	10	MPS1-0300-LAC	24.0	33.0	38.0	78.0	78.0	78.0	78.0	78.0	
		MPS1-0300-L10C	30.0	37.5	42.5	79.5	79.5	79.5	79.5	79.5	
		MPS1-0300-L12C	39.0	43.0	48.0	85.0	85.0	85.0	85.0	85.0	
15	15	MPS1-0300-L14C	45.0	52.0	57.0	84.0	84.0	84.0	84.0	84.0	
		MPS1-0300-L20C	60.0	67.0	72.0	109.0	109.0	109.0	109.0	109.0	
		MPS1-0300-L20C	75.0	82.0	87.0	124.0	124.0	124.0	124.0	124.0	
30	30	MPS1-0300-L30C	90.0	97.0	102.0	139.0	139.0	139.0	139.0	139.0	
		MPS1-0300-L30C	105.0	112.0	117.0	158.0	158.0	158.0	158.0	158.0	
		MPS1-0300-L40C	120.0	128.0	135.0	170.0	170.0	170.0	170.0	170.0	

● Есть на складе. □ Нет на складе, выпускается исключительно под заказ.

ДОПУСК НА ДИАМЕТР

ТИП ПРОДУКЦИИ

ГЕОМЕТРИЯ

ИНСТРУМЕНТ ДЛЯ СВЕРЛЕНИЯ (СВЕРЛА СО СМЕННЫМИ ПЛАСТИНАМИ)

TAW

● Возможность замены кромки сверла для улучшения условий за стружкой.
 ● Специальные режущие пластины для точной установки пластины.
 ● Легкая замена пластины.

Для общей обработки

● Тип 1 Цилиндрический тип хвостовика

● Тип 2 Цилиндрический тип хвостовика

● Тип 3 Тип хвостовика Whistle notch

● Тип 4 Тип хвостовика Whistle notch

● Тип 5 Тип хвостовика Whistle notch

DC (mm)	Тип	D1/D2	Обозначение	Размеры (mm)							Контршпатель	Ключ	Диаметр	Смазка	Пластина			
				LU	LCF	LH	LF	LF1	PC	PC2/D2								
18.5	3	3	TAWSN1900S25	58.0	71.4	102.4	158.4	155.0	25	WS3040177	TKY10T	WP74405	MK1KS	18.6	18.6	18.6	18.6	18.6
			TAWWN1900S25	95.0	110.4	137.4	193.4	190.0	25	WS3040177	TKY10T	WP74405	MK1KS	18.7	18.7	18.7	18.7	18.7
			TAWLN1900S25	151.4	165.4	188.4	244.4	241.0	25	WS3040177	TKY10T	WP74405	MK1KS	18.8	18.8	18.8	18.8	18.8
	5	5	TAWSN1900S25	62.0	75.5	102.5	158.5	155.0	25	WS3040181	TKY10T	WP74405	MK1KS	19.0	19.0	19.0	19.0	19.0
			TAWWN1900S25	101.0	116.5	142.5	198.5	195.0	25	WS3040181	TKY10T	WP74405	MK1KS	19.1	19.1	19.1	19.1	19.1
			TAWLN1900S25	159.5	173.5	196.5	252.5	249.0	25	WS3040181	TKY10T	WP74405	MK1KS	19.2	19.2	19.2	19.2	19.2
	10	10	TAWSN1900S25	62.0	75.5	102.5	158.5	155.0	25	WS3040181	TKY10T	WP74405	MK1KS	19.3	19.3	19.3	19.3	19.3
			TAWWN1900S25	101.0	116.5	142.5	198.5	195.0	25	WS3040181	TKY10T	WP74405	MK1KS	19.4	19.4	19.4	19.4	19.4
			TAWLN1900S25	159.5	173.5	196.5	252.5	249.0	25	WS3040181	TKY10T	WP74405	MK1KS	19.5	19.5	19.5	19.5	19.5
	19.5	19.5	TAWSN1900S25	62.0	75.5	102.5	158.5	155.0	25	WS3040181	TKY10T	WP74405	MK1KS	19.6	19.6	19.6	19.6	19.6
			TAWWN1900S25	101.0	116.5	142.5	198.5	195.0	25	WS3040181	TKY10T	WP74405	MK1KS	19.7	19.7	19.7	19.7	19.7
			TAWLN1900S25	159.5	173.5	196.5	252.5	249.0	25	WS3040181	TKY10T	WP74405	MK1KS	19.8	19.8	19.8	19.8	19.8
	20.4	20.4	TAWSN1900S25	62.0	75.5	102.5	158.5	155.0	25	WS3040181	TKY10T	WP74405	MK1KS	19.9	19.9	19.9	19.9	19.9
			TAWWN1900S25	101.0	116.5	142.5	198.5	195.0	25	WS3040181	TKY10T	WP74405	MK1KS	20.0	20.0	20.0	20.0	20.0
			TAWLN1900S25	159.5	173.5	196.5	252.5	249.0	25	WS3040181	TKY10T	WP74405	MK1KS	20.1	20.1	20.1	20.1	20.1
30	30	TAWSN1900S25	62.0	75.5	102.5	158.5	155.0	25	WS3040181	TKY10T	WP74405	MK1KS	20.2	20.2	20.2	20.2	20.2	
		TAWWN1900S25	101.0	116.5	142.5	198.5	195.0	25	WS3040181	TKY10T	WP74405	MK1KS	20.3	20.3	20.3	20.3	20.3	
		TAWLN1900S25	159.5	173.5	196.5	252.5	249.0	25	WS3040181	TKY10T	WP74405	MK1KS	20.4	20.4	20.4	20.4	20.4	

Примечание 1) Приведенные выше размеры (*) указаны для случая установленных на корпус пластины.
 Примечание 2) Показатели, связанные с номером, если вы не нашли нужную геометрию в данном каталоге, могут быть заказаны другие диаметры и длины.

● Есть на складе. □ Нет на складе, выпускается исключительно под заказ. (Примечание: 1 пластина в наборе)

ОБОЗНАЧЕНИЕ ПРОДУКЦИИ
 указывает диаметры, номера заказа, наличие на складе, количество зубьев, размеры и запасные части для соответствующего инструмента.

УСЛОВНОЕ ОБОЗНАЧЕНИЕ И ОПИСАНИЕ НАЛИЧИЯ НА СКЛАДЕ
 Показано на левой странице каждого разворота.

ИНСТРУМЕНТ ДЛЯ СВЕРЛЕНИЯ

ОБОЗНАЧЕНИЕ ПРОДУКЦИИ	M002
ОПИСАНИЕ ОБОЗНАЧЕНИЙ	M003
СХЕМА ВЫБОРА СВЕРЛА	M004

ТИПЫ СВЕРЛ

МОНОЛИТНЫЕ ТВЕРДОСПЛАВНЫЕ СВЕРЛА

MSE	[Микросверла]	M008
MSP	[Центровочные сверла]	M011
DLE	[Сверла для центrovания и обработки фасок]	M012
MINI-MFE	[Сверла с плоским торцом]	M018
NEW MINI-DWAE	[Сверла для автоматов швейцарского типа и станков с ЧПУ]	M020
NEW DWAE	[Сверла для автоматов швейцарского типа и станков с ЧПУ]	M021
MINI-MVS	[Сверла с четырьмя ленточками и внутренним охлаждением]	M036
MINI-MWS	[Сверла с двумя ленточками и внутренним охлаждением]	M040
MPS1	[Сверхдлинные сверла с четырьмя ленточками]	M044
MPS	[Сверхдлинные сверла с четырьмя ленточками]	M062
MSL	[Сверхдлинные сверла с двумя ленточками]	M074
MICRO-MGS	[Однокромочные сверла с внутренним охлаждением]	M079
MMS	[Уникальные сверла для сверления нержавеющей стали]	M082
NEW DSAS	[Сверла для обработки жаропрочных сплавов]	M096
MNS	[Сверла с 4-мя отверстиями для подвода СОЖ для алюминия]	M100
MAE/MAS	[Высокоточные сверла для алюминия и чугуна]	M124
MHS	[Высокоточные сверла для твердых материалов]	M130

СВЕРЛА С АЛМАЗНЫМ ПОКРЫТИЕМ

MCC	[Сверла для станков с ЧПУ / для CFRP]	M188
MCA	[Сверла для станков с ЧПУ / для CFRP и алюминия]	M189
MCT	[Сверла для станков с ЧПУ / для CFRP и титана]	M190
MCW	[Сверла для станков с ЧПУ / для CFRP и пакетных материалов высокой точности]	M191
MCCH	[Сверла для ручного инструмента / для CFRP]	M192
MCAH	[Сверла для ручного инструмента / для CFRP и алюминия]	M193

СВЕРЛА СО СМЕННЫМИ ПЛАСТИНАМИ

STAW	[Сверла малого диаметра со сменными пластинами]	M141
TAW	[Сверла со сменными пластинами]	M150
MVX	[Сверла со сменными пластинами]	M160
ТОЧНАЯ ПЕРЕХОДНАЯ ВТУЛКА		M172

СВЕРЛА HSS

СВЕРЛА VIOLET

VAPDS	[HSS-Co - быстрорежущие короткие сверла для стали]	M174
VAPDM	[HSS-Co - быстрорежущие средние сверла для стали]	M179
VSD	[HSS-Co - быстрорежущие длинные сверла для нержавеющей стали]	M183
VAPDSCB	[HSS-Co - быстрорежущие сверла для зенкования]	M185

*Алфавитный указатель

M012 DLE
M096 DSAS
M021 DWAE
M172 JFS (Втулка)
M124 MAE
M124 MAS
M189 MCA
M193 MCAH
M188 MCC
M192 MCCH
M190 MCT
M191 MCW

M130 MHS
M079 MICRO-MGS
M020 MINI-DWAE
M018 MINI-MFE
M036 MINI-MVS
M040 MINI-MWS
M082 MMS
M100 MNS
M062 MPS
M044 MPS1
M008 MSE
M074 MSL

M011 MSP
M160 MVX
M168 MVX (ПЛАСТИНЫ)
M141 STAW
M144 STAW (ПЛАСТИНЫ)
M150 TAW
M155 TAW (ПЛАСТИНЫ)
M179 VAPDM
M174 VAPDS
M185 VAPDSCB
M183 VSD



Пожалуйста, замените все будущие заказы изделий, отмеченных серым цветом (MPS,MSL), на серию MPS1 с немедленным вступлением в силу. Это связано с тем, что производство MPS, MSL будет постепенно прекращаться и остановится в марте 2023 года.

ОБОЗНАЧЕНИЕ ПРОДУКЦИИ

ОБОЗНАЧЕНИЕ СВЕРЛ

ИНСТРУМЕНТ ДЛЯ СВЕРЛЕНИЯ

M

Наименование сверла	Тип охлаждения	Диаметр	L/D	Тип хвостовика
MV	S	0300	X	S
DLE : DLE Сверла DSA : DSAS Сверла DWA : DWAE Сверла MPS1 : MPS1 Сверла MV : MVS Сверла MW : MWS Сверла MF : MFE Сверла MG : MGS Сверла MSL : MSL Сверла MP : MPS Сверла MA : MAE/MAS Сверла MS : MSE Сверла MM : MMS Сверла MN : MNS Сверла MH : MHS Сверла MC : MC Сверла	E : Наружное охлаждение S : Внутреннее охлаждение	Пример 0050 → ϕ 0.5 0300 → ϕ 3.0	S : 2D M : 3D L : 5D (MAE / MAS Тип=6D) L8C : 8D L10C : 10D L12C : 12D L15C : 15D L20C : 20D L25C : 25D L30C : 30D L40C : 40D X : 12D X8DB : 8D X10DB : 10D X15DB : 15D X20DB : 20D X25DB : 25D X30DB : 30D	A : Хвостовик того же диаметра, что и сверло. B : Хвостовик с фиксированным диаметром. C : Цилиндрический тип хвостовика S*** : Диаметр хвостовика

* Исключения частично включаются.

Наименование сверла	Область применения	Длина винтовой канавки	Диаметр
VA	PD	S	D0050
VA : Сверла высокой точности с покрытием VIOLET (Высококачественные, быстрорежущая сталь) V : VIOLET Сверла	SD : Прямое сверло общего применения PD : Для высокоточной обработки	S : Короткая M : Средняя	Пример D0300 → ϕ 3.0 D0050 → ϕ 0.5

* Исключения частично включаются.



Пожалуйста, замените все будущие заказы изделий, отмеченных серым цветом (MPS,MSL), на серию MPS1 с немедленным вступлением в силу. Это связано с тем, что производство MPS, MSL будет постепенно прекращаться и остановится в марте 2023 года.

ОПИСАНИЕ ОБОЗНАЧЕНИЙ

Материал режущего инструмента



Сверхмикрозернистый твердый сплав

Сверхмикрозернистый твердый сплав используется в качестве материала субстрата



Высококачественная высоколегированная быстрорежущая сталь

Высококачественная высоколегированная быстрорежущая сталь используется в качестве основного материала.



Кобальтовая быстрорежущая сталь

В качестве основы используется кобальтовая быстрорежущая сталь.



Быстрорежущая сталь

В качестве основы используется быстрорежущая сталь.

Подточка перемычки



X заострение перемычки

X заострение перемычки используется на поперечной кромке сверла.



Z заострение перемычки

Z заострение перемычки используется на поперечной кромке сверла.



XR заострение перемычки

XR заострение перемычки используется на поперечной кромке сверла.



N заострение перемычки

N заострение перемычки используется на поперечной кромке сверла.

Допуск



Допуск на диаметр сверла



Допуск на диаметр хвостовика

Отверстие для подачи СОЖ



С отверстием для подачи СОЖ

ДИАПАЗОН ОБРАБАТЫВАЕМЫХ МАТЕРИАЛОВ

1-ая рекомендация



Не рекомендуется



Покрытие



Покрытие MIRACLE

Оригинальное покрытие MIRACLE (Al, Ti)N.

Также применяется для сухого резания.



Покрытие PVD

DP102A твердый сплав с покрытием PVD, который специально предназначен для сверл малого диаметра и обладает существенно повышенной износостойкостью.



Покрытие PVD

Характеризуется исключительной износостойкостью при обработке широкого спектра материалов: сталь, материалы на основе чугуна и алюминиевые сплавы.



Покрытие PVD

Сверхмикрозернистый спеченный твердый сплав оптимален для обработки нержавеющей стали, а покрытие PVD обладает исключительной жаропрочностью и гладкостью поверхности.



Покрытие PVD

DP9020 обеспечивает высокую износостойкость и сопротивление излому и более длительный срок службы инструмента.



Покрытие VIOLET

Увеличенный срок службы инструмента в 2-3 раза, чем срок службы инструмента с покрытием из TiN



Алмазное покрытие CVD

Уникальная технология многослойных микрозернистых алмазных кристаллов значительно повышает износостойкость и гладкость обработки поверхности.

Угол и острота режущей кромки



Двойной угол в плане

Указывает угол между режущими кромками сверла при вершине.







M

ИНСТРУМЕНТ ДЛЯ СВЕРЛЕНИЯ

ТАБЛИЦА ВЫБОРА СВЕРЛ

ИНСТРУМЕНТ ДЛЯ СВЕРЛЕНИЯ

























M

Материал режущего инструмента	Диапазон размеров	Глубина сверления (L/D)	Код	Охлаждение	Покрытие	Обрабатываемый материал						Форма	Номер страницы	
						Р	М	К	N	S	H		Размеры	Режимы резания
						Углеродистая сталь, легированная сталь	Нержавеющая сталь	Чугун	Легкий сплав	Жаропрочные сплавы	Закалённая сталь			
Монолитные Твердосплавные Сверла	φ0.1 - φ0.99	5-12	MSE	Наружное	VP	○	○	○	○	○			M008	M009
	φ1.0 - φ16.0	-	DLE	Наружное	DP1 DP1A	○	○	○					M012	M016
	φ0.75 - φ2.95	2	MINI-MFE	Наружное	DP1A	○	○	○	○				M018	M019
	φ1.0 - φ2.9	2,4	MINI-DWAE	Наружное	DP1A	○	○	○					M020	M027
	φ3.0 - φ14.0	2,4	DWAE	Наружное	DP1A	○	○	○					M021	M027
	φ1.0 - φ2.9	*2-30	MINI-MVS	Внутреннее	DP1	○	○	○	○				M036	M038
	φ0.5 - φ0.99	1-12	MINI-MWS	Внутреннее	VP	○	○	○	○				M040	M042
	φ3.0 - φ20.0	3-40	MPS1	Внутреннее	DP1	○	○	○					M044	M059
	φ3.0 - φ20.0	3-40	MPS	Внутреннее	VP	○	○	○	○				M062	M077
	φ3.0 - φ14.0	20-30	MSL	Внутреннее	VP	○	○	○	○				M074	M077
	φ0.95 - φ12.0	1-30	MHS	Внутреннее	VP	○	○		○	○			M130	M138
	φ3.0 - φ20.0	3, 5	MMS	Внутреннее	DP7		○						M082	M094
	φ3.0 - φ12.0	3	DSAS	Внутреннее	DP9					○			M096	M099
	φ0.7 - φ3.0	-80	MICRO-MGS	Внутреннее	-	○	○	○	○				M079	M080

*2=пилотное сверло. Допуск +0.014 глубина отверстия DCx2.



Пожалуйста, замените все будущие заказы изделий, отмеченных серым цветом (MPS,MSL), на серию MPS1 с немедленным вступлением в силу. Это связано с тем, что производство MPS, MSL будет постепенно прекращаться и остановится в марте 2023 года.

Материал режущего инструмента	Диапазон размеров	Глубина сверления (L/D)	Код	Охлаждение	Покрытие	Обрабатываемый материал						Форма	Номер страницы	
						Р	М	К	N	S	H		Размеры	Режимы резания
						Углеродистая сталь, легированная сталь	Нержавеющая сталь	Чугун	Легкий сплав	Жаропрочные сплавы	Закалённая сталь			
Монолитные твердосплавные сверла	φ3.0 – φ16.0	3	MAE	Наружное	–			○	○				M124	M129
	φ3.0 – φ16.0	3, 6	MAS	Внутреннее	–			○	○				M124	M129
	φ3.0 – φ20.0	3–30	MNS	Внутреннее	–				○				M100	M120
	φ4.76 – φ11.14	3	MCC	Наружное		Для Углепластика						M188	M188	
	φ6.38 – φ9.55	5	MCA	Внутреннее		Для Углепластика + Al						M189	M189	
	φ6.38 – φ9.55	5	MCT	Внутреннее	–	Для Углепластика + Ti						M190	M190	
	φ6.38 – φ9.55	5	MCW	Внутреннее		Для обработки углепластика и высокопрочного сверления пакетных материалов						M191	M191	
	φ2.5 – φ9.55	2–15	MCCH	Наружное	–	Для Углепластика						M192	Руководство по ручному инструменту	
	φ2.5 – φ9.55	3–15	MCAH	Наружное	–	Для Углепластика + Al						M193	Руководство по ручному инструменту	
Сверла из быстрорежущей стали	φ0.5 – φ13.0	2–3	VAPDS	Наружное		○	○	○					M174	M178
	φ0.5 – φ32.0	3–6	VAPDM	Наружное		○	○	○					M179	M182
	φ0.5 – φ13.0	3–6	VSD	Наружное		○	○						M183	M184
	φ2.0 – φ32.0	2–3	VAPDSCB	Наружное		○	○	○					M185	M187
Сверла со сменными пластинами	φ10.0 – φ18.4	1.5–8	STAW	Внутреннее		○	○	○					M141	M146
	φ18.5 – φ30.4	3–8	TAW	Внутреннее		○	○	○					M150	M157
	φ17.0 – φ63.0	2–6	MVX	Внутреннее	–	○	○	○		○			M160	M169

○ : 1-я рекомендация / ○ : 2-я рекомендация

M

ИНСТРУМЕНТ ДЛЯ СВЕРЛЕНИЯ

СЕРИИ СВЕРЛ

1-я рекомендация



2-я рекомендация



■ МОНОЛИТНЫЕ ТВЕРДОСПЛАВНЫЕ СВЕРЛА

MPS (тип с двойной ленточкой)

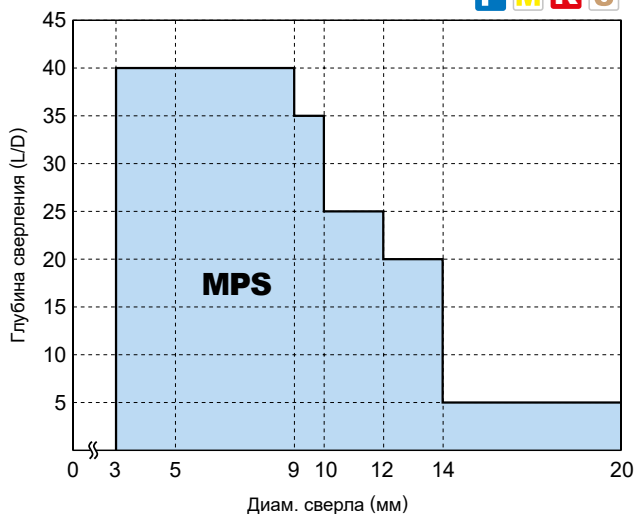

MPS1 (тип с двойной ленточкой)

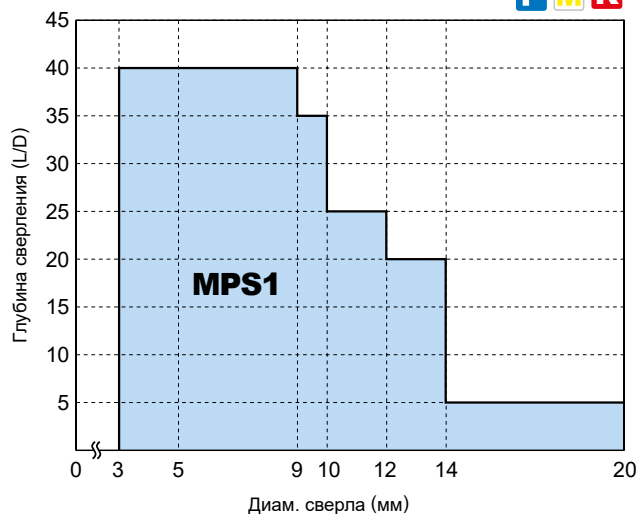

MICRO-MGS

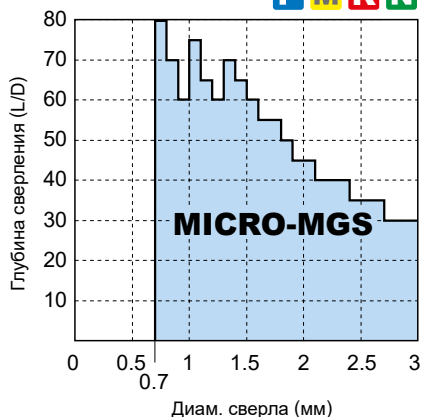

MINI-MVS, MINI-MWS

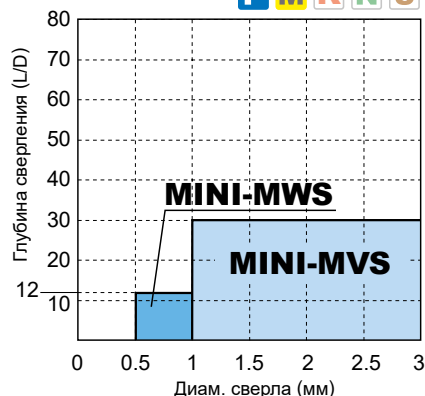

MINI-DWAE, DWAE

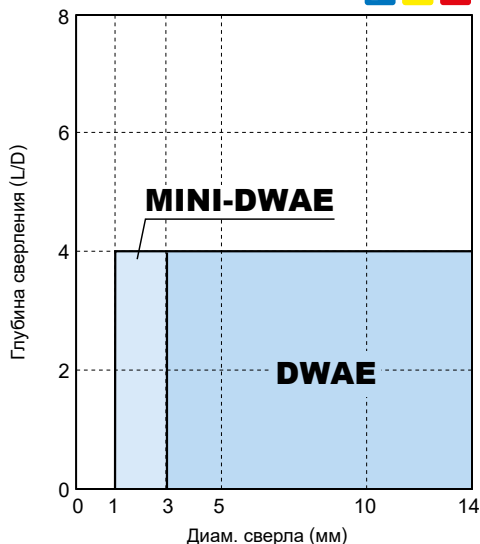

MINI-MFE

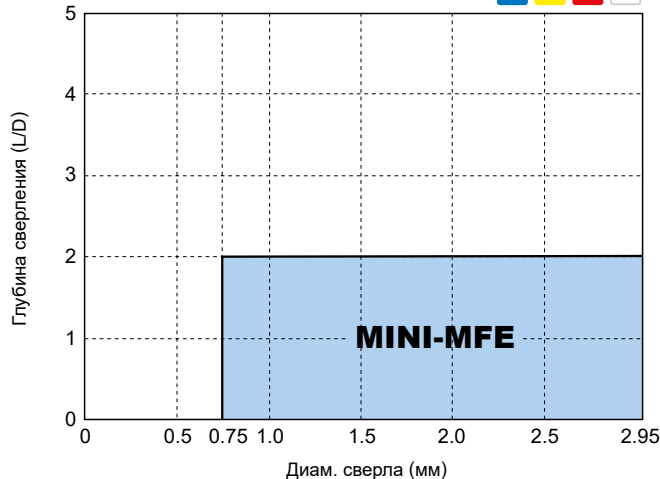

M

ИНСТРУМЕНТ ДЛЯ СВЕРЛЕНИЯ

1-я рекомендация

P M K N S H

2-я рекомендация

P M K N S H

■ МОНОЛИТНЫЕ ТВЕРДОСПЛАВНЫЕ СВЕРЛА

MMS (для обработки нержавеющей стали) **DSAS** (для обработки жаропрочных сплавов)

M

S

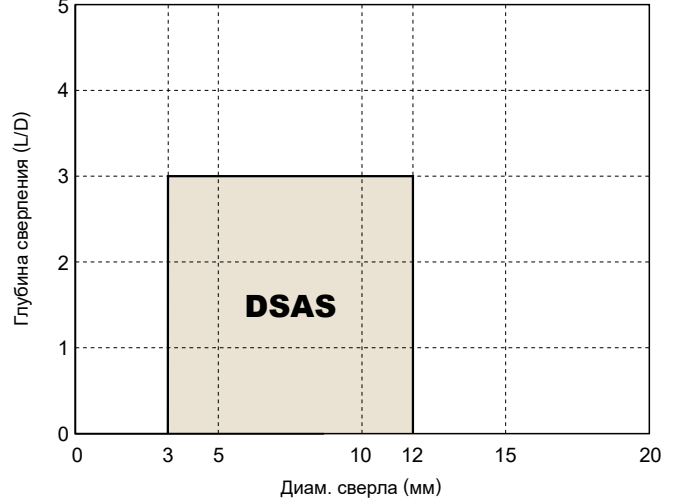
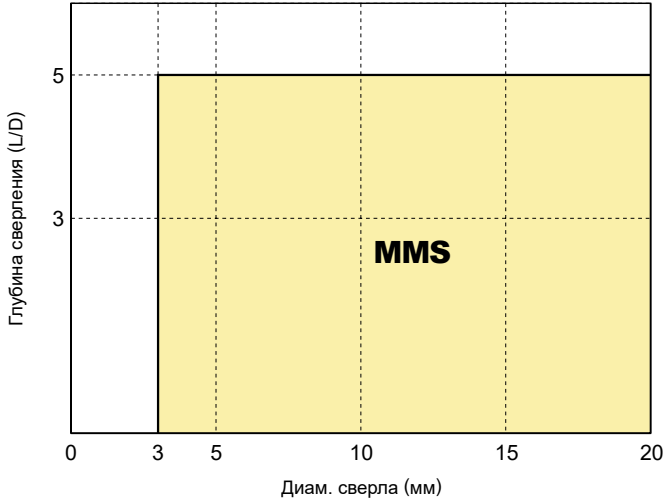

M

ИНСТРУМЕНТ ДЛЯ СВЕРЛЕНИЯ

MNS (для обработки алюминиевых сплавов)

N

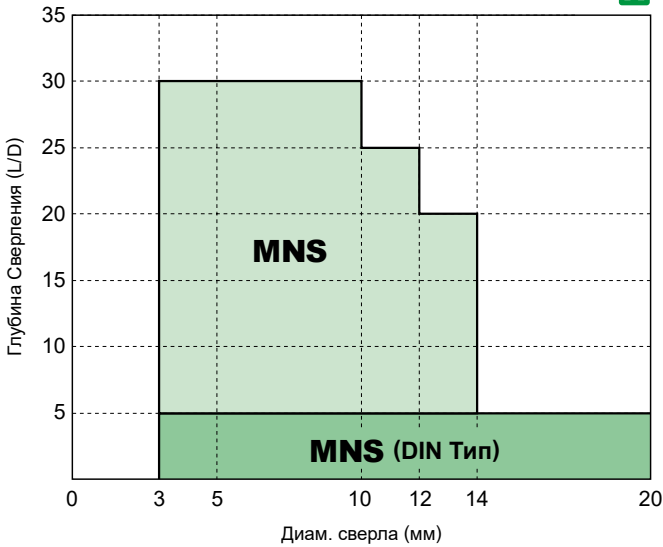

MHS (для обработки штампов и пресс-форм)

P M S H

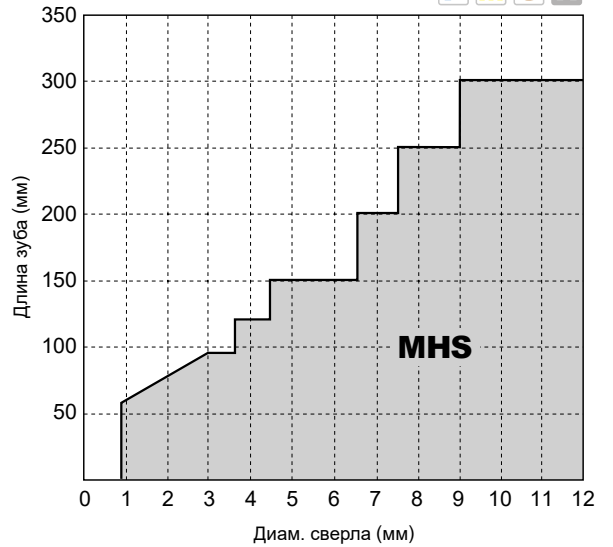

■ СВЕРЛА СО СМЕННЫМИ ПЛАСТИНАМИ

S-TAW, TAW

P M K

MVX

P M K N H

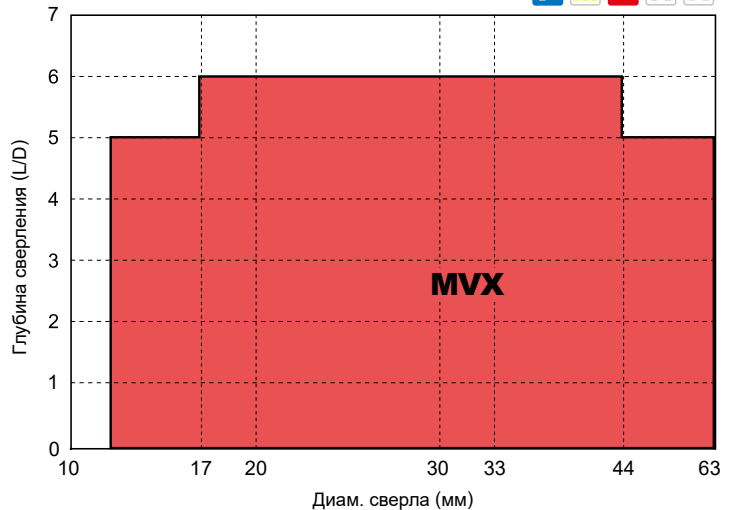
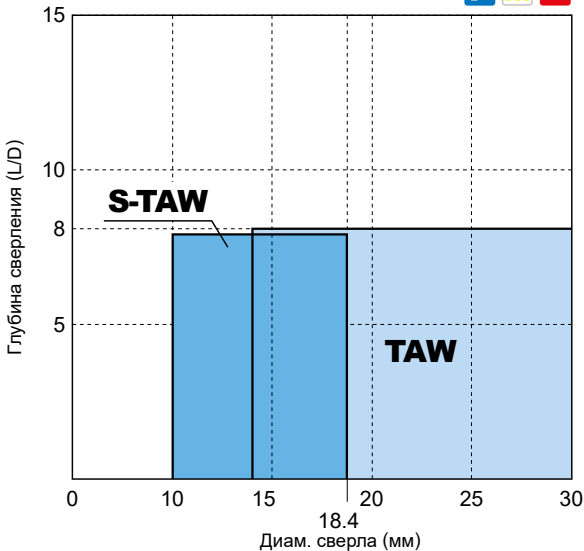

ИНСТРУМЕНТ ДЛЯ СВЕРЛЕНИЯ (МОНОЛИТНЫЕ ТВЕРДОСПЛАВНЫЕ СВЕРЛА)

ТВЕРДЫЙ СПЛАВ

MSE

- Широкая канавка предотвращает забивание стружкой.
- Стабильная обработка малым диаметром.



- P M K N S H

Наружное охлаждение

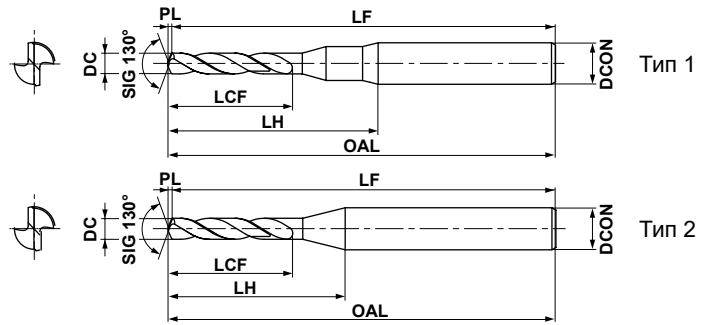

$$0.10 \leq DC \leq 0.99$$

$$-0.009$$

$$DCON=3$$



$$-0.006$$

● Сверла MSE предназначены для использования с термоматрицами.

DC (мм)	VP20MF	VP15TF	Обозначение	Размеры (мм)						Тип
				LCF	LH	OAL	LF	PL	DCON	
0.10	●		MSE0010SB	1.2	9.7	38.0	38	0.02	3	1
0.11	★		MSE0011SB	1.2	9.7	38.0	38	0.03	3	1
0.12	★		MSE0012SB	1.4	9.7	38.0	38	0.03	3	1
0.13	★		MSE0013SB	1.4	9.7	38.0	38	0.03	3	1
0.14	★		MSE0014SB	2.0	9.7	38.0	38	0.03	3	1
0.15	●		MSE0015SB	2.0	9.7	38.0	38	0.03	3	1
0.16	★		MSE0016SB	2.0	9.7	38.0	38	0.04	3	1
0.17	★		MSE0017SB	2.0	9.7	38.0	38	0.04	3	1
0.18	★		MSE0018SB	2.0	9.7	38.0	38	0.04	3	1
0.19	★		MSE0019SB	2.0	9.7	38.0	38	0.04	3	1
0.20	●		MSE0020SB	2.6	9.8	38.1	38	0.05	3	1
0.21	★		MSE0021SB	2.6	9.8	38.1	38	0.05	3	1
0.22	★		MSE0022SB	2.6	9.8	38.1	38	0.05	3	1
0.23	★		MSE0023SB	2.6	9.8	38.1	38	0.05	3	1
0.24	★		MSE0024SB	3.1	9.8	38.1	38	0.06	3	1
0.25	●		MSE0025SB	3.1	9.8	38.1	38	0.06	3	1
0.26	★		MSE0026SB	3.1	9.8	38.1	38	0.06	3	1
0.27	★		MSE0027SB	3.1	9.8	38.1	38	0.06	3	1
0.28	★		MSE0028SB	3.1	9.8	38.1	38	0.07	3	1
0.29	★		MSE0029SB	3.1	9.8	38.1	38	0.07	3	1
0.30	●		MSE0030SB	5.1	10.3	38.1	38	0.07	3	2
0.31	★		MSE0031SB	5.1	10.3	38.1	38	0.07	3	2
0.32	★		MSE0032SB	5.1	10.3	38.1	38	0.07	3	2
0.33	★		MSE0033SB	5.1	10.3	38.1	38	0.08	3	2
0.34	★		MSE0034SB	6.1	11.3	38.1	38	0.08	3	2
0.35	●		MSE0035SB	6.1	11.2	38.1	38	0.08	3	2
0.36	★		MSE0036SB	6.1	11.2	38.1	38	0.08	3	2
0.37	★		MSE0037SB	6.1	11.2	38.1	38	0.09	3	2
0.38	★		MSE0038SB	6.1	11.2	38.1	38	0.09	3	2
0.39	★		MSE0039SB	6.1	11.2	38.1	38	0.09	3	2
0.40	●		MSE0040SB	7.1	12.2	38.1	38	0.09	3	2
0.41	★		MSE0041SB	7.1	12.1	38.1	38	0.10	3	2
0.42	★		MSE0042SB	7.1	12.1	38.1	38	0.10	3	2
0.43	★		MSE0043SB	7.1	12.1	38.1	38	0.10	3	2

DC (мм)	VP20MF	VP15TF	Обозначение	Размеры (мм)						Тип
				LCF	LH	OAL	LF	PL	DCON	
0.44	★		MSE0044SB	7.1	12.1	38.1	38	0.10	3	2
0.45	●		MSE0045SB	7.1	12.1	38.1	38	0.10	3	2
0.46	★		MSE0046SB	7.1	12.0	38.1	38	0.11	3	2
0.47	★		MSE0047SB	7.1	12.0	38.1	38	0.11	3	2
0.48	★		MSE0048SB	7.1	12.0	38.1	38	0.11	3	2
0.49	★		MSE0049SB	7.1	12.0	38.1	38	0.11	3	2
0.50	●		MSE0050SB	7.1	12.0	38.1	38	0.12	3	2
0.51	★		MSE0051SB	7.1	11.9	38.1	38	0.12	3	2
0.52	★		MSE0052SB	7.1	11.9	38.1	38	0.12	3	2
0.53	★		MSE0053SB	7.1	11.9	38.1	38	0.12	3	2
0.54	★		MSE0054SB	7.1	11.9	38.1	38	0.13	3	2
0.55	●		MSE0055SB	7.1	11.9	38.1	38	0.13	3	2
0.56	★		MSE0056SB	7.1	11.9	38.1	38	0.13	3	2
0.57	★		MSE0057SB	7.1	11.8	38.1	38	0.13	3	2
0.58	★		MSE0058SB	7.1	11.8	38.1	38	0.14	3	2
0.59	★		MSE0059SB	7.1	11.8	38.1	38	0.14	3	2
0.60	●		MSE0060SB	7.1	11.8	38.1	38	0.14	3	2
0.61	★		MSE0061SB	7.1	11.8	38.1	38	0.14	3	2
0.62	★		MSE0062SB	7.1	11.7	38.1	38	0.14	3	2
0.63	★		MSE0063SB	7.2	11.8	38.2	38	0.15	3	2
0.64	★		MSE0064SB	7.2	11.8	38.2	38	0.15	3	2
0.65	●		MSE0065SB	7.2	11.8	38.2	38	0.15	3	2
0.66	★		MSE0066SB	7.2	11.8	38.2	38	0.15	3	2
0.67	★		MSE0067SB	7.2	11.7	38.2	38	0.16	3	2
0.68	★		MSE0068SB	7.2	11.7	38.2	38	0.16	3	2
0.69	★		MSE0069SB	7.2	11.7	38.2	38	0.16	3	2
0.70	●		MSE0070SB	8.2	12.7	38.2	38	0.16	3	2
0.71	★		MSE0071SB	8.2	12.7	38.2	38	0.17	3	2
0.72	★		MSE0072SB	8.2	12.7	38.2	38	0.17	3	2
0.73	★		MSE0073SB	8.2	12.6	38.2	38	0.17	3	2
0.74	★		MSE0074SB	8.2	12.6	38.2	38	0.17	3	2
0.75	●		MSE0075SB	8.2	12.6	38.2	38	0.17	3	2
0.76	★		MSE0076SB	8.2	12.6	38.2	38	0.18	3	2
0.77	★		MSE0077SB	8.2	12.6	38.2	38	0.18	3	2

Примечание 1) Пожалуйста, свяжитесь с нами если Вы не нашли нужную геометрию в данном каталоге (могут быть заказаны другие диаметры и длины).

● : Есть на складе. ★ : Со склада в Японии.

DC (мм)	VP20MF	VP15TF	Обозначение	Размеры (мм)						Тип
				LCF	LH	OAL	LF	PL	DCON	
0.78	★	★	MSE0078SB	8.2	12.5	38.2	38	0.18	3	2
0.79	★	★	MSE0079SB	8.2	12.5	38.2	38	0.18	3	2
0.80	●	●	MSE0080SB	10.2	14.5	38.2	38	0.19	3	2
0.81	★	★	MSE0081SB	10.2	14.5	38.2	38	0.19	3	2
0.82	★	★	MSE0082SB	10.2	14.5	38.2	38	0.19	3	2
0.83	★	★	MSE0083SB	10.2	14.5	38.2	38	0.19	3	2
0.84	★	★	MSE0084SB	10.2	14.4	38.2	38	0.20	3	2
0.85	●	●	MSE0085SB	10.2	14.4	38.2	38	0.20	3	2
0.86	★	★	MSE0086SB	10.2	14.4	38.2	38	0.20	3	2
0.87	★	★	MSE0087SB	10.2	14.4	38.2	38	0.20	3	2
0.88	★	★	MSE0088SB	10.2	14.4	38.2	38	0.21	3	2

DC (мм)	VP20MF	VP15TF	Обозначение	Размеры (мм)						Тип
				LCF	LH	OAL	LF	PL	DCON	
0.89	★	★	MSE0089SB	10.2	14.3	38.2	38	0.21	3	2
0.90	●	●	MSE0090SB	10.2	14.3	38.2	38	0.21	3	2
0.91	★	★	MSE0091SB	10.2	14.3	38.2	38	0.21	3	2
0.92	★	★	MSE0092SB	10.2	14.3	38.2	38	0.21	3	2
0.93	★	★	MSE0093SB	10.2	14.3	38.2	38	0.22	3	2
0.94	★	★	MSE0094SB	10.2	14.2	38.2	38	0.22	3	2
0.95	●	●	MSE0095SB	10.2	14.2	38.2	38	0.22	3	2
0.96	★	★	MSE0096SB	10.2	14.2	38.2	38	0.22	3	2
0.97	★	★	MSE0097SB	10.2	14.2	38.2	38	0.23	3	2
0.98	★	★	MSE0098SB	10.2	14.2	38.2	38	0.23	3	2
0.99	●	●	MSE0099SB	10.2	14.2	38.2	38	0.23	3	2

РЕКОМЕНДУЕМЫЕ РЕЖИМЫ РЕЗАНИЯ

Обработываемый материал	P										
	Малолуглеродистые стали (≤180HB) Ck10						Углеродистая сталь, Легированная сталь (180—280HB) Ck45, 41CrMo4				
Диам. сверла DC (мм)	Скорость резания (м/мин)	Частота вращения (мин ⁻¹)	Подача (мин.—макс.) (мм/об)	Шаг (мм)	Подача (мм/мин)	Скорость резания (м/мин)	Частота вращения (мин ⁻¹)	Подача (мин.—макс.) (мм/об)	Шаг (мм)	Подача (мм/мин)	
0.10	6	20000	0.002 (0.001—0.003)	0.02	40	6	20000	0.002 (0.001—0.003)	0.02	40	
0.12	8	20000	0.002 (0.001—0.003)	0.02	40	8	20000	0.002 (0.001—0.003)	0.02	40	
0.16	10	20000	0.002 (0.001—0.003)	0.02	40	10	20000	0.002 (0.001—0.003)	0.02	40	
0.20	13	20000	0.003 (0.002—0.004)	0.04	60	13	20000	0.003 (0.002—0.004)	0.04	60	
0.25	16	20000	0.003 (0.002—0.004)	0.04	60	16	20000	0.003 (0.002—0.004)	0.04	60	
0.32	20	20000	0.004 (0.003—0.005)	0.05	80	20	20000	0.004 (0.003—0.005)	0.05	80	
0.40	25	20000	0.004 (0.003—0.005)	0.05	80	25	20000	0.004 (0.003—0.005)	0.05	80	
0.50	31	20000	0.006 (0.005—0.007)	0.10	120	31	20000	0.006 (0.005—0.007)	0.10	120	
0.63	40	20000	0.008 (0.006—0.010)	0.10	160	40	20000	0.008 (0.006—0.010)	0.10	160	
0.80	50	20000	0.020 (0.015—0.025)	0.30	400	50	20000	0.015 (0.012—0.018)	0.30	300	
0.99	62	20000	0.040 (0.030—0.050)	0.30	800	62	20000	0.020 (0.015—0.025)	0.30	400	

Обработываемый материал	P										
	Углеродистая сталь, Легированная сталь (280—350HB) 36CrNiMo4						Предварительно закалённая сталь (35—45HRC) X36CrMo17				
Диам. сверла DC (мм)	Скорость резания (м/мин)	Частота вращения (мин ⁻¹)	Подача (мин.—макс.) (мм/об)	Шаг (мм)	Подача (мм/мин)	Скорость резания (м/мин)	Частота вращения (мин ⁻¹)	Подача (мин.—макс.) (мм/об)	Шаг (мм)	Подача (мм/мин)	
0.10	6	20000	0.002 (0.001—0.003)	0.02	40	6	20000	0.002 (0.001—0.003)	0.02	40	
0.12	8	20000	0.002 (0.001—0.003)	0.02	40	8	20000	0.002 (0.001—0.003)	0.02	40	
0.16	10	20000	0.002 (0.001—0.003)	0.02	40	10	20000	0.002 (0.001—0.003)	0.02	40	
0.20	13	20000	0.003 (0.002—0.004)	0.04	60	13	20000	0.003 (0.002—0.004)	0.04	60	
0.25	16	20000	0.003 (0.002—0.004)	0.04	60	16	20000	0.003 (0.002—0.004)	0.04	60	
0.32	20	20000	0.004 (0.003—0.005)	0.05	80	20	20000	0.004 (0.003—0.005)	0.05	80	
0.40	25	20000	0.004 (0.003—0.005)	0.05	80	25	20000	0.004 (0.003—0.005)	0.05	80	
0.50	31	20000	0.006 (0.005—0.007)	0.10	120	31	20000	0.006 (0.005—0.007)	0.10	120	
0.63	40	20000	0.008 (0.006—0.010)	0.10	160	40	20000	0.008 (0.006—0.010)	0.10	160	
0.80	50	20000	0.015 (0.012—0.018)	0.30	300	50	20000	0.015 (0.012—0.018)	0.30	300	
0.99	62	20000	0.020 (0.015—0.025)	0.30	400	62	20000	0.020 (0.015—0.025)	0.30	400	

Примечание 1) При сверлении до $\phi 0.3$ мм рекомендуется использовать центровочное сверло.

Примечание 2) Измените режимы резания в зависимости от жесткости станка и заготовки.

Примечание 3) При глубине сверления свыше DCx5 снизьте установленную ранее глубину ступенчатого сверления.

Примечание 4) Для сверления при выше указанных режимах резания рекомендуется использовать СОЖ (разбавленную в пропорции 1:20).

Примечание 5) Материал, труднообрабатываемый с наружным охлаждением, маркируется знаком " - " в приведенной выше таблице.

ИНСТРУМЕНТ ДЛЯ СВЕРЛЕНИЯ (МОНОЛИТНЫЕ ТВЕРДОСПЛАВНЫЕ СВЕРЛА)

- Широкая канавка предотвращает забивание стружкой.
- Стабильная обработка малым диаметром.

MSE

ТВЕРДЫЙ СПЛАВ

РЕКОМЕНДУЕМЫЕ РЕЖИМЫ РЕЗАНИЯ

Обрабатываемый материал	M					K					
	Диам. сверла DC (мм)	Скорость резания (м/мин)	Частота вращения (мин ⁻¹)	Подача (мин. — макс.) (мм/об)	Шаг (мм)	Подача (мм/мин)	Скорость резания (м/мин)	Частота вращения (мин ⁻¹)	Подача (мин. — макс.) (мм/об)	Шаг (мм)	Подача (мм/мин)
Аустенитная нержавеющая сталь (≤200НВ) X5CrNi1810, X5CrNiMo17-12-2						Серый чугун (≤350МПа) GG30					
	0.10	6	20000	0.002 (0.001—0.003)	0.02	40	6	20000	0.002 (0.001—0.003)	0.02	40
	0.12	8	20000	0.002 (0.001—0.003)	0.02	40	8	20000	0.002 (0.001—0.003)	0.02	40
	0.16	10	20000	0.002 (0.001—0.003)	0.02	40	10	20000	0.002 (0.001—0.003)	0.02	40
	0.20	11	18000	0.003 (0.002—0.004)	0.04	54	13	20000	0.003 (0.002—0.004)	0.04	60
	0.25	14	18000	0.003 (0.002—0.004)	0.04	54	16	20000	0.003 (0.002—0.004)	0.04	60
	0.32	15	15000	0.004 (0.003—0.005)	0.05	60	20	20000	0.004 (0.003—0.005)	0.05	80
	0.40	19	15000	0.004 (0.003—0.005)	0.05	60	25	20000	0.004 (0.003—0.005)	0.05	80
	0.50	16	10000	0.006 (0.005—0.007)	0.10	60	31	20000	0.006 (0.005—0.007)	0.10	120
	0.63	20	10000	0.008 (0.006—0.010)	0.10	80	40	20000	0.008 (0.006—0.010)	0.10	160
	0.80	15	6000	0.015 (0.012—0.018)	0.20	90	50	20000	0.020 (0.015—0.025)	0.30	400
	0.99	19	6000	0.020 (0.015—0.025)	0.20	120	62	20000	0.040 (0.030—0.050)	0.30	800

Обрабатываемый материал	N					S					
	Диам. сверла DC (мм)	Скорость резания (м/мин)	Частота вращения (мин ⁻¹)	Подача (мин. — макс.) (мм/об)	Шаг (мм)	Подача (мм/мин)	Скорость резания (м/мин)	Частота вращения (мин ⁻¹)	Подача (мин. — макс.) (мм/об)	Шаг (мм)	Подача (мм/мин)
Алюминиевые сплавы (Si<5%)						Жаропрочные сплавы Inconel718					
	0.10	6	20000	0.002 (0.001—0.003)	0.05	40	2	7000	0.001 (0.0005—0.001)	0.02	7
	0.12	8	20000	0.003 (0.002—0.004)	0.05	60	3	7000	0.001 (0.0005—0.001)	0.02	7
	0.16	10	20000	0.004 (0.003—0.005)	0.05	80	4	7000	0.001 (0.0005—0.001)	0.02	7
	0.20	13	20000	0.006 (0.005—0.007)	0.10	120	3	5000	0.002 (0.001—0.002)	0.04	10
	0.25	16	20000	0.008 (0.006—0.010)	0.10	160	4	5000	0.002 (0.001—0.002)	0.04	10
	0.32	20	20000	0.010 (0.008—0.012)	0.30	200	4	4000	0.002 (0.001—0.002)	0.05	8
	0.40	25	20000	0.020 (0.015—0.025)	0.30	400	5	4000	0.002 (0.001—0.002)	0.05	8
	0.50	31	20000	0.030 (0.025—0.035)	0.50	600	5	3000	0.003 (0.001—0.003)	0.10	9
	0.63	40	20000	0.040 (0.035—0.045)	0.50	800	6	3000	0.004 (0.002—0.004)	0.10	12
	0.80	50	20000	0.050 (0.045—0.055)	0.80	1000	5	1800	0.006 (0.004—0.006)	0.20	10.8
	0.99	62	20000	0.060 (0.055—0.065)	0.80	1200	6	1800	0.010 (0.008—0.010)	0.20	18

Примечание 1) При сверлении до $\phi 0.3$ мм рекомендуется использовать центровочное сверло.

Примечание 2) Измените режимы резания в зависимости от жесткости станка и заготовки.

Примечание 3) При глубине сверления свыше DCx5 снизьте установленную ранее глубину ступенчатого сверления.

Примечание 4) Для сверления при выше указанных режимах резания рекомендуется использовать СОЖ (разбавленную в пропорции 1:20).

Примечание 5) Материал, труднообрабатываемый с наружным охлаждением, маркируется знаком " - " в приведенной выше таблице.

MSP

ЦЕНТРОВОЧНЫЕ СВЕРЛА



ТВЕРДЫЙ
СПЛАВ

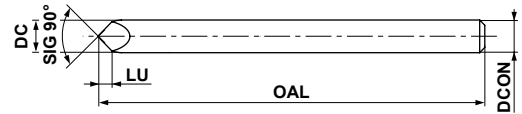

Обозначение	Сплав	Наличие	Размеры (мм)				Диапазон диаметров (мм)
			DC	LU	OAL	DCON	
MSP0300SB	VP15TF	●	3.0	1.5	38.0	3.0	0.1—3.0

РЕКОМЕНДУЕМЫЕ РЕЖИМЫ РЕЗАНИЯ

Диапазон диаметров отверстий (мм)	Частота вращения (МИН ⁻¹)	Подача (мин. — макс.) (мм/об)	Подача (мм/мин)
0.1—3.0	10000	0.0005 (0.00025—0.001)	5

M

ИНСТРУМЕНТ ДЛЯ
СВЕРЛЕНИЯ

● : Есть на складе.

ИНСТРУМЕНТ ДЛЯ СВЕРЛЕНИЯ (МОНОЛИТНЫЕ ТВЕРДОСПЛАВНЫЕ СВЕРЛА)

DLE

Серия направляющих сверл



Наружное охлаждение

■ Угол при вершине SIG 60°, 90°

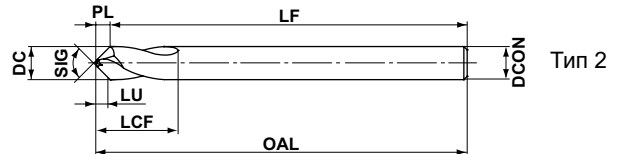
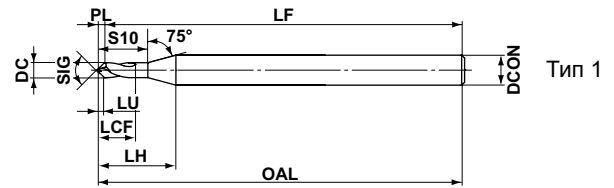

■ Угол при вершине SIG 120°, 145°

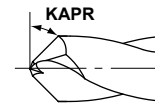

DCON=3	3 < DCON ≤ 6	6 < DCON ≤ 10	10 < DCON ≤ 16
$\begin{matrix} 0 \\ -0.010 \end{matrix}$	$\begin{matrix} 0 \\ -0.012 \end{matrix}$	$\begin{matrix} 0 \\ -0.015 \end{matrix}$	$\begin{matrix} 0 \\ -0.018 \end{matrix}$

DC (мм)	SIG	DP1020 DP102A	Обозначение	Размеры (мм)									Тип
				LU	LCF	LH	S10	OAL	LF	PL	KAPR	DCON	
NEW 3.0	60°	●	DLE0300S030P060	2.0	9	—	—	45	42.9	2.1	60°	3	2
NEW 4.0	60°	●	DLE0400S040P060	2.7	12	—	—	50	47.2	2.8	60°	4	2
NEW 5.0	60°	●	DLE0500S050P060	3.4	14	—	—	60	56.5	3.5	60°	5	2
NEW 6.0	60°	●	DLE0600S060P060	4.0	15	—	—	66	61.8	4.2	60°	6	2
NEW 7.0	60°	●	DLE0700S070P060	4.7	18	—	—	74	69.1	4.9	60°	7	2
NEW 8.0	60°	●	DLE0800S080P060	5.4	20	—	—	74	68.4	5.6	60°	8	2
NEW 10.0	60°	●	DLE1000S100P060	6.8	24	—	—	84	77.0	7.0	60°	10	2
NEW 12.0	60°	●	DLE1200S120P060	8.1	28	—	—	95	86.6	8.4	60°	12	2
NEW 1.0	90°	●	DLE0100S030P090	0.35	2	6.7	3.0	45	44.6	0.4	45°	3	1
NEW 1.5	90°	●	DLE0150S030P090	0.55	3	7.3	4.5	45	44.4	0.6	45°	3	1
NEW 2.0	90°	●	DLE0200S030P090	0.8	4	7.9	6.1	45	44.1	0.9	45°	3	1
NEW 2.5	90°	●	DLE0250S030P090	1.0	5	7.9	7.1	45	43.9	1.1	45°	3	1
3.0	90°	●	DLE0300S030P090	1.2	9	—	—	45	43.7	1.3	45°	3	2
4.0	90°	●	DLE0400S040P090	1.6	12	—	—	50	48.3	1.7	45°	4	2
5.0	90°	●	DLE0500S050P090	2.0	14	—	—	60	57.9	2.1	45°	5	2
6.0	90°	●	DLE0600S060P090	2.4	15	—	—	66	63.4	2.6	45°	6	2
7.0	90°	●	DLE0700S070P090	2.8	18	—	—	74	71.0	3.0	45°	7	2
8.0	90°	●	DLE0800S080P090	3.2	20	—	—	74	70.6	3.4	45°	8	2
10.0	90°	●	DLE1000S100P090	4.1	24	—	—	84	79.7	4.3	45°	10	2
12.0	90°	●	DLE1200S120P090	4.9	28	—	—	95	89.9	5.1	45°	12	2
16.0	90°	●	DLE1600S160P090	6.6	35	—	—	113	106.2	6.8	45°	16	2

Примечание 1) Из за двойной заточки вершины, на участке примерно DC/4, угол дна отверстия не будет равен 60° и 90°.

Обработка фасок в этой области также невозможна.

Примечание 2) диаметр центрующего отверстия должен быть меньше диаметра сверла (диаметра обрабатываемой поверхности) DC, а полезную длину LU следует использовать в качестве ориентира.

● : Есть на складе. ★ : Со склада в Японии.

DC (мм)	SIG	DP1020	DP102A	Обозначение	Размеры (мм)								Тип	
					LU	LCF	LH	S10	OAL	LF	PL	KAPR		DCON
NEW 3.0	120°	●		DLE0300S030P120	0.8	9	—	—	45	44.1	0.9	30°	3	2
NEW 4.0	120°	●		DLE0400S040P120	1.1	12	—	—	50	48.8	1.2	30°	4	2
NEW 5.0	120°	●		DLE0500S050P120	1.3	14	—	—	60	58.6	1.4	30°	5	2
NEW 6.0	120°	●		DLE0600S060P120	1.6	15	—	—	66	64.3	1.7	30°	6	2
NEW 7.0	120°	●		DLE0700S070P120	1.9	18	—	—	74	72.0	2.0	30°	7	2
NEW 8.0	120°	●		DLE0800S080P120	2.2	20	—	—	74	71.7	2.3	30°	8	2
NEW 10.0	120°	●		DLE1000S100P120	2.8	24	—	—	84	81.1	2.9	30°	10	2
NEW 12.0	120°	●		DLE1200S120P120	3.3	28	—	—	95	91.5	3.5	30°	12	2
NEW 3.0	145°	●		DLE0300S030P145	0.4	9	—	—	45	44.5	0.5	17.5°	3	2
NEW 4.0	145°	●		DLE0400S040P145	0.5	12	—	—	50	49.4	0.6	17.5°	4	2
NEW 5.0	145°	●		DLE0500S050P145	0.7	14	—	—	60	59.2	0.8	17.5°	5	2
NEW 6.0	145°	●		DLE0600S060P145	0.8	15	—	—	66	65.1	0.9	17.5°	6	2
NEW 7.0	145°	●		DLE0700S070P145	1.0	18	—	—	74	72.9	1.1	17.5°	7	2
NEW 8.0	145°	●		DLE0800S080P145	1.1	20	—	—	74	72.7	1.3	17.5°	8	2
NEW 10.0	145°	●		DLE1000S100P145	1.4	24	—	—	84	82.4	1.6	17.5°	10	2
NEW 12.0	145°	●		DLE1200S120P145	1.7	28	—	—	95	93.1	1.9	17.5°	12	2

Примечание 1) диаметр центрующего отверстия должен быть меньше диаметра сверла (диаметра обрабатываемой поверхности) DC, а полезную длину LU следует использовать в качестве ориентира.

M

ИНСТРУМЕНТ ДЛЯ
СВЕРЛЕНИЯ

ВЫБОР ДИАМЕТРА СВЕРЛА

ПРИ ОБРАБОТКЕ ФАСОК

С учетом диаметра направляющего отверстия **D** выберите диаметр сверла (диаметр режущего инструмента) **DC** в следующем диапазоне: $D < DC < 2D$.

M

ИНСТРУМЕНТ ДЛЯ СВЕРЛЕНИЯ

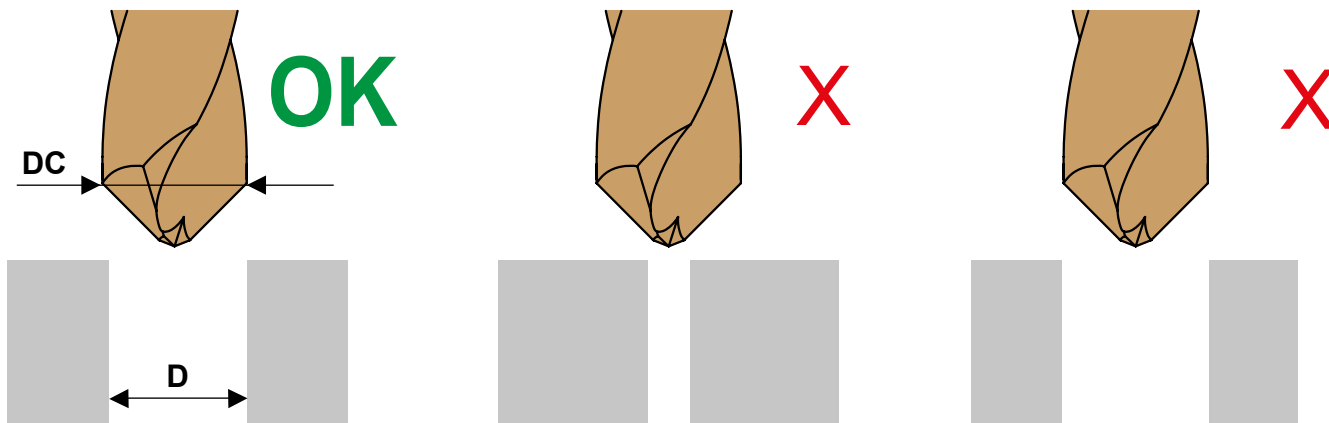

Пример: если диаметр направляющего отверстия **D** равен 5 мм, диаметр сверла **DC** должен быть больше или равен 6 мм, но меньше 10 мм. Выберите сверло с диаметром **DC** 6, 7 или 8 мм.

Если диаметр **DC** больше или равен удвоенному диаметру (**2D**):
Если диаметр сверла **DC** намного больше диаметра направляющего отверстия **D** (равен и больше **2D**), обработка фасок невозможна.

Если диаметр сверла **DC** равен диаметру **D**:
Обработку фасок невозможно выполнить, если диаметр сверла **DC** равен диаметру направляющего отверстия **D**.

ПРИ ЦЕНТРОВАНИИ

Диаметр центрующего отверстия (диаметр обрабатываемой поверхности) должен быть меньше диаметра сверла **DC**, а полезную длину **LU** следует использовать в качестве ориентира.

Центральная область отверстий (приблизительно 25 % полного диаметра), образуемая двухступенчатой заточкой вершины, не будет иметь ее углы 60° и 90° соответственно. Обработка фасок в этой центральной области также невозможна.

Выбирайте центровочное сверло с большим углом при вершине, чем у сверла для окончательного сверления отверстия, потому что требуется начальный контакт в центре.

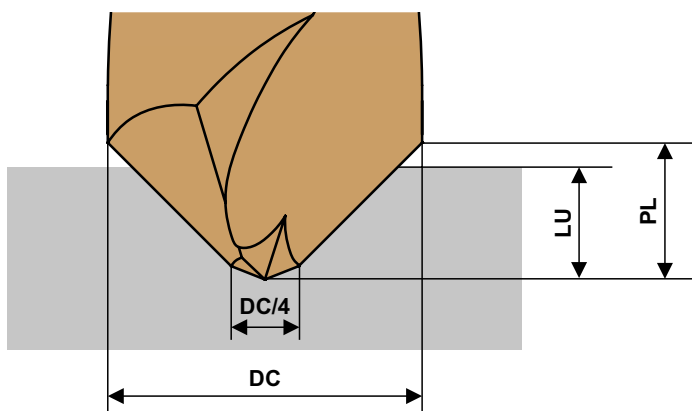

Следующий процесс сверления

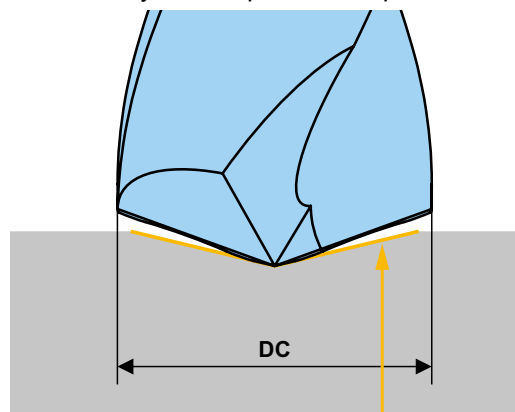

Центрирование при вершине угла SIG=145°

Таблица глубины сверления (L) в зависимости от диаметра инструментов

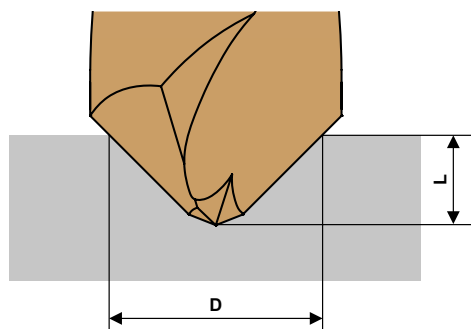

(мм)

DC	SIG 90°			
	Min.		Max.	
	D	L	D	L
1.0	0.5	0.18	0.8	0.33
1.5	0.8	0.29	1.3	0.54
2.0	1.0	0.35	1.9	0.8
2.5	1.3	0.47	2.4	1.0
3.0	1.5	0.5	2.8	1.2
4.0	2.0	0.7	3.8	1.6
5.0	2.5	0.9	4.7	2.0
6.0	3.0	1.1	5.7	2.4
7.0	3.5	1.2	6.6	2.8
8.0	4.0	1.4	7.6	3.2
10.0	5.0	1.8	9.7	4.1
12.0	6.0	2.1	11.6	4.9
16.0	8.0	2.8	15.5	6.6

M

ИНСТРУМЕНТ ДЛЯ
СВЕРЛЕНИЯ

(мм)

DC	SIG 60°				SIG 120°				SIG 145°			
	Min.		Max.		Min.		Max.		Min.		Max.	
	D	L	D	L	D	L	D	L	D	L	D	L
3.0	1.5	0.8	2.9	2.0	1.5	0.4	2.8	0.8	1.5	0.2	2.5	0.4
4.0	2.0	1.1	3.9	2.7	2.0	0.6	3.8	1.1	2.0	0.3	3.2	0.5
5.0	2.5	1.3	4.9	3.4	2.5	0.7	4.5	1.3	2.5	0.4	4.4	0.7
6.0	3.0	1.6	5.8	4.0	3.0	0.9	5.5	1.6	3.0	0.5	5.1	0.8
7.0	3.5	1.9	6.8	4.7	3.5	1.0	6.6	1.9	3.5	0.6	6.3	1.0
8.0	4.0	2.1	7.8	5.4	4.0	1.2	7.6	2.2	4.0	0.6	7.0	1.1
10.0	5.0	2.7	9.8	6.8	5.0	1.4	9.7	2.8	5.0	0.8	8.9	1.4
12.0	6.0	3.2	11.6	8.1	6.0	1.7	11.4	3.3	6.0	0.9	10.8	1.7

ИНСТРУМЕНТ ДЛЯ СВЕРЛЕНИЯ (МОНОЛИТНЫЕ ТВЕРДОСПЛАВНЫЕ СВЕРЛА)

DLE

Серия направляющих сверл

Угол при вершине SIG 60°

РЕКОМЕНДУЕМЫЕ РЕЖИМЫ РЕЗАНИЯ

Обрабатываемый материал	P					
	Малоуглеродистые стали ($\leq 180\text{HB}$) DIN C10E и т. д.		Углеродистая сталь, Легированная сталь (180—280HB) DIN Ck45, 41CrMo4 и т. д.		Углеродистая сталь, Легированная сталь (280—350HB) DIN 40CrNiMoA и т. д.	
Диам. сверла DC (мм)	Частота вращения (мин ⁻¹)	Подача (мин.—макс.) (мм/об)	Частота вращения (мин ⁻¹)	Подача (мин.—макс.) (мм/об)	Частота вращения (мин ⁻¹)	Подача (мин.—макс.) (мм/об)
3.0	7900	0.05 (0.03—0.07)	6800	0.05 (0.03—0.07)	6300	0.04 (0.02—0.06)
4.0	5900	0.05 (0.03—0.07)	5100	0.05 (0.03—0.07)	4700	0.04 (0.02—0.06)
5.0	5000	0.06 (0.04—0.08)	4400	0.06 (0.04—0.08)	4100	0.05 (0.03—0.07)
6.0	4200	0.06 (0.04—0.08)	3700	0.06 (0.04—0.08)	3400	0.05 (0.03—0.07)
7.0	3600	0.07 (0.04—0.09)	3100	0.07 (0.04—0.09)	2900	0.05 (0.03—0.07)
8.0	3100	0.07 (0.04—0.09)	2700	0.07 (0.04—0.09)	2500	0.05 (0.03—0.07)
10.0	2700	0.08 (0.04—0.10)	2300	0.08 (0.04—0.10)	2200	0.06 (0.03—0.08)
12.0	2200	0.08 (0.04—0.10)	1900	0.08 (0.04—0.10)	1800	0.06 (0.03—0.08)

Обрабатываемый материал	M		K			
	Аустенитная нержавеющая сталь ($\leq 200\text{HB}$) DIN X5CrNi189, X5CrNiMo1810 и т. д.		Серый чугун ($\leq 350\text{MPa}$) DIN GG30 и т. д.		Ковкий чугун ($\leq 450\text{MPa}$) DIN GGG40.3 и т. д.	
Диам. сверла DC (мм)	Частота вращения (мин ⁻¹)	Подача (мин.—макс.) (мм/об)	Частота вращения (мин ⁻¹)	Подача (мин.—макс.) (мм/об)	Частота вращения (мин ⁻¹)	Подача (мин.—макс.) (мм/об)
3.0	1500	0.03 (0.01—0.05)	7900	0.05 (0.03—0.07)	5800	0.05 (0.03—0.07)
4.0	1100	0.03 (0.01—0.05)	5900	0.05 (0.03—0.07)	4300	0.05 (0.03—0.07)
5.0	1200	0.04 (0.02—0.06)	5000	0.06 (0.04—0.08)	3800	0.06 (0.04—0.08)
6.0	1000	0.04 (0.02—0.06)	4200	0.06 (0.04—0.08)	3100	0.06 (0.04—0.08)
7.0	900	0.04 (0.02—0.06)	3600	0.07 (0.04—0.09)	2700	0.06 (0.04—0.08)
8.0	790	0.04 (0.02—0.06)	3100	0.07 (0.04—0.09)	2300	0.06 (0.04—0.08)
10.0	630	0.04 (0.02—0.06)	2700	0.08 (0.04—0.10)	1900	0.07 (0.04—0.09)
12.0	530	0.04 (0.02—0.06)	2200	0.08 (0.04—0.10)	1500	0.07 (0.04—0.09)

Примечание 1) Используйте сверло, которое больше диаметром (DC), чем требуемое центральное отверстие, но меньше, чем 2 x DC.



Примечание 2) При центрировании на криволинейных или наклонных поверхностях снижайте подачу.

Примечание 3) При обработке V-образных канавок и обработке фасок снижайте режимы резания.

Примечание 4) При возникновении дребезжания, вибрации или постороннего шума, сократите время выстоя или уменьшите число оборотов.

Примечание 5) При центрировании не превышайте LU (полезную длину).

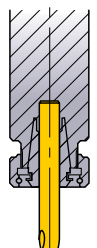
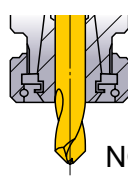
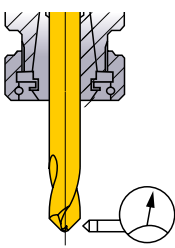
ИНСТРУКЦИЯ ПО ЭКСПЛУАТАЦИИ

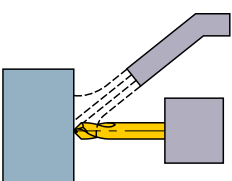
<p>Крепление сверла</p>  <p>Цанговый патрон с упорным подшипником надежно держит сверло.</p>	<p>Длина сверла</p>  <p>NG</p> <p>Не прижимать по режущей кромке.</p>	<p>Допуск на установку</p>  <p>Биение $\leq 0.03\text{мм}$</p>	<p>Тонкая заготовка</p> <p>OK Необходима опора для заготовки.</p> <p>X Если наблюдается отгиб.</p> 	<p>Метод охлаждения</p>  <p>В идеале необходимы две позиции охлаждения - в конце и в центре.</p>
--	---	---	--	--

Угол при вершине SIG 90°, 120° и 145°

РЕКОМЕНДУЕМЫЕ РЕЖИМЫ РЕЗАНИЯ

Обрабатываемый материал	P					
	Малоуглеродистые стали ($\leq 180\text{HB}$) DIN C10E и т. д.		Углеродистая сталь, Легированная сталь (180—280HB) DIN Ck45, 41CrMo4 и т. д.		Углеродистая сталь, Легированная сталь (280—350HB) DIN 40CrNiMoA и т. д.	
Диам. сверла DC (мм)	Частота вращения (мин ⁻¹)	Подача (мин.—макс.) (мм/об)	Частота вращения (мин ⁻¹)	Подача (мин.—макс.) (мм/об)	Частота вращения (мин ⁻¹)	Подача (мин.—макс.) (мм/об)
1.0	9500	0.02 (0.01—0.03)	6300	0.02 (0.01—0.03)	4700	0.02 (0.01—0.03)
1.5	9500	0.02 (0.01—0.03)	7400	0.02 (0.01—0.03)	6300	0.02 (0.01—0.03)
2.0	9500	0.04 (0.03—0.05)	7900	0.04 (0.03—0.05)	7100	0.04 (0.03—0.05)
2.5	9500	0.04 (0.03—0.05)	8200	0.04 (0.03—0.05)	7600	0.04 (0.03—0.05)
3.0	7900	0.06 (0.04—0.08)	6800	0.06 (0.04—0.08)	6300	0.05 (0.03—0.07)
4.0	5900	0.06 (0.04—0.08)	5100	0.06 (0.04—0.08)	4700	0.05 (0.03—0.07)
5.0	5000	0.07 (0.05—0.09)	4400	0.07 (0.05—0.09)	4100	0.06 (0.04—0.08)
6.0	4200	0.07 (0.05—0.09)	3700	0.07 (0.05—0.09)	3400	0.06 (0.04—0.08)
7.0	3600	0.08 (0.05—0.10)	3100	0.08 (0.05—0.10)	2900	0.06 (0.04—0.08)
8.0	3100	0.08 (0.05—0.10)	2700	0.08 (0.05—0.10)	2500	0.06 (0.04—0.08)
10.0	2700	0.09 (0.05—0.11)	2300	0.09 (0.05—0.11)	2200	0.07 (0.04—0.09)
12.0	2200	0.09 (0.05—0.11)	1900	0.09 (0.05—0.11)	1800	0.07 (0.04—0.09)
16.0	1700	0.12 (0.10—0.14)	1500	0.12 (0.10—0.14)	1400	0.08 (0.06—0.10)

Обрабатываемый материал	M		K			
	Аустенитная нержавеющая сталь ($\leq 200\text{HB}$) DIN X5CrNi189, X5CrNiMo1810 и т. д.		Серый чугун ($\leq 350\text{МПа}$) DIN GG30 и т. д.		Ковкий чугун ($\leq 450\text{МПа}$) DIN GGG40.3 и т. д.	
Диам. сверла DC (мм)	Частота вращения (мин ⁻¹)	Подача (мин.—макс.) (мм/об)	Частота вращения (мин ⁻¹)	Подача (мин.—макс.) (мм/об)	Частота вращения (мин ⁻¹)	Подача (мин.—макс.) (мм/об)
1.0	6300	0.01 (0.005—0.015)	9500	0.02 (0.01—0.03)	3100	0.02 (0.01—0.03)
1.5	4200	0.01 (0.005—0.015)	9500	0.02 (0.01—0.03)	5300	0.02 (0.01—0.03)
2.0	3100	0.04 (0.03—0.05)	9500	0.04 (0.03—0.05)	6300	0.04 (0.03—0.05)
2.5	2500	0.04 (0.03—0.05)	9500	0.04 (0.03—0.05)	7000	0.04 (0.03—0.05)
3.0	2100	0.04 (0.02—0.06)	7900	0.06 (0.04—0.08)	5800	0.06 (0.04—0.08)
4.0	1600	0.04 (0.02—0.06)	5900	0.06 (0.04—0.08)	4300	0.06 (0.04—0.08)
5.0	1200	0.06 (0.04—0.08)	5000	0.07 (0.05—0.09)	3800	0.07 (0.05—0.09)
6.0	1000	0.06 (0.04—0.08)	4200	0.07 (0.05—0.09)	3100	0.07 (0.05—0.09)
7.0	900	0.06 (0.04—0.08)	3600	0.08 (0.05—0.10)	2700	0.07 (0.05—0.09)
8.0	790	0.06 (0.04—0.08)	3100	0.08 (0.05—0.10)	2300	0.07 (0.05—0.09)
10.0	630	0.06 (0.04—0.08)	2700	0.09 (0.05—0.11)	1900	0.08 (0.05—0.10)
12.0	530	0.06 (0.04—0.08)	2200	0.09 (0.05—0.11)	1500	0.08 (0.05—0.10)
16.0	390	0.08 (0.06—0.10)	1700	0.12 (0.10—0.14)	1100	0.11 (0.09—0.13)

Примечание 1) Используйте сверло, которое больше диаметром (DC), чем требуемое центральное отверстие, но меньше, чем 2 x DC.

Примечание 2) При центрировании на криволинейных или наклонных поверхностях снижайте подачу.

Примечание 3) При обработке V-образных канавок и обработке фасок снижайте режимы резания.

Примечание 4) При возникновении дребезжания, вибрации или постороннего шума, сократите время выстоя или уменьшите число оборотов.

Примечание 5) При центрировании не превышайте LU (полезную длину).

M

ИНСТРУМЕНТ ДЛЯ
СВЕРЛЕНИЯ

ИНСТРУМЕНТ ДЛЯ СВЕРЛЕНИЯ (МОНОЛИТНЫЕ ТВЕРДОСПЛАВНЫЕ СВЕРЛА)

MINI-MFE Для малого диаметра



P

M

K

N

S

H

Наружное охлаждение

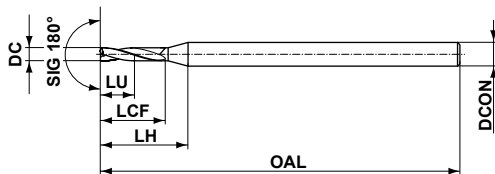

Тип 1

M

ИНСТРУМЕНТ ДЛЯ СВЕРЛЕНИЯ

$0.75 \leq DC \leq 2.95$	
0 -0.014	
DCON=3	DCON=4
0 -0.006	0 -0.008

DC (мм)	Глубина сверления (L/D)	DP102A	Обозначение	Размеры (мм)					Тип
				LU	LCF	LH	OAL	DCON	
0.75	2	★	MFE0075X02S030	1.5	3.0	7.7	45	3	1
0.80	2	★	MFE0080X02S030	1.6	3.2	7.8	45	3	1
0.85	2	★	MFE0085X02S030	1.7	3.4	7.9	45	3	1
0.90	2	★	MFE0090X02S030	1.8	3.6	8.0	45	3	1
0.95	2	★	MFE0095X02S030	1.9	3.8	8.1	45	3	1
1.00	2	★	MFE0100X02S030	2.0	4.0	8.2	45	3	1
1.05	2	★	MFE0105X02S030	2.1	4.2	8.3	45	3	1
1.10	2	★	MFE0110X02S030	2.2	4.4	8.4	45	3	1
1.15	2	★	MFE0115X02S030	2.3	4.6	8.6	45	3	1
1.20	2	★	MFE0120X02S030	2.4	4.8	8.7	45	3	1
1.25	2	★	MFE0125X02S030	2.5	5.0	8.8	45	3	1
1.30	2	★	MFE0130X02S030	2.6	5.2	8.9	45	3	1
1.35	2	★	MFE0135X02S030	2.7	5.4	9.0	45	3	1
1.40	2	★	MFE0140X02S030	2.8	5.6	9.1	45	3	1
1.45	2	★	MFE0145X02S030	2.9	5.8	9.2	45	3	1
1.50	2	★	MFE0150X02S030	3.0	6.0	9.3	45	3	1
1.55	2	★	MFE0155X02S030	3.1	6.2	9.4	45	3	1
1.60	2	★	MFE0160X02S030	3.2	6.4	9.5	45	3	1
1.65	2	★	MFE0165X02S030	3.3	6.6	9.6	45	3	1
1.70	2	★	MFE0170X02S030	3.4	6.8	9.7	45	3	1
1.75	2	★	MFE0175X02S030	3.5	7.0	9.8	45	3	1
1.80	2	★	MFE0180X02S030	3.6	7.2	9.9	45	3	1
1.85	2	★	MFE0185X02S030	3.7	7.4	10.0	45	3	1
1.90	2	★	MFE0190X02S030	3.8	7.6	10.2	45	3	1
1.95	2	★	MFE0195X02S030	3.9	7.8	10.3	45	3	1
2.00	2	★	MFE0200X02S040	4.0	8.0	12.2	50	4	1
2.05	2	★	MFE0205X02S040	4.1	8.2	12.3	50	4	1
2.10	2	★	MFE0210X02S040	4.2	8.4	12.4	50	4	1
2.15	2	★	MFE0215X02S040	4.3	8.6	12.6	50	4	1
2.20	2	★	MFE0220X02S040	4.4	8.8	12.7	50	4	1
2.25	2	★	MFE0225X02S040	4.5	9.0	12.8	50	4	1
2.30	2	★	MFE0230X02S040	4.6	9.2	12.9	50	4	1
2.35	2	★	MFE0235X02S040	4.7	9.4	13.0	50	4	1
2.40	2	★	MFE0240X02S040	4.8	9.6	13.1	50	4	1
2.45	2	★	MFE0245X02S040	4.9	9.8	13.2	50	4	1
2.50	2	★	MFE0250X02S040	5.0	10.0	13.3	50	4	1
2.55	2	★	MFE0255X02S040	5.1	10.2	13.4	50	4	1
2.60	2	★	MFE0260X02S040	5.2	10.4	13.5	50	4	1
2.65	2	★	MFE0265X02S040	5.3	10.6	13.6	50	4	1
2.70	2	★	MFE0270X02S040	5.4	10.8	13.7	50	4	1
2.75	2	★	MFE0275X02S040	5.5	11.0	13.8	50	4	1
2.80	2	★	MFE0280X02S040	5.6	11.2	13.9	50	4	1
2.85	2	★	MFE0285X02S040	5.7	11.4	14.0	50	4	1
2.90	2	★	MFE0290X02S040	5.8	11.6	14.2	50	4	1
2.95	2	★	MFE0295X02S040	5.9	11.8	14.3	50	4	1

★ : Со склада в Японии.

РЕКОМЕНДУЕМЫЕ РЕЖИМЫ РЕЗАНИЯ

Обрабатываемый материал		P					
		Малоуглеродистые стали ($\leq 180\text{HB}$) C10E и т. д.		Углеродистая сталь, Легированная сталь (180—280HB) DIN Ck45, 41CrMo4 и т. д.		Углеродистая сталь, Легированная сталь (280—350HB) DIN 40CrNiMoA и т. д.	
Диам. сверла DC (мм)	L/D	Частота вращения (мин ⁻¹)	$\alpha=0^\circ$ Подача (мин.—макс.) (мм/об)	Частота вращения (мин ⁻¹)	$\alpha=0^\circ$ Подача (мин.—макс.) (мм/об)	Частота вращения (мин ⁻¹)	$\alpha=0^\circ$ Подача (мин.—макс.) (мм/об)
0.75	≤ 2	23300	0.030 (0.010—0.050)	19000	0.030 (0.010—0.050)	16900	0.030 (0.010—0.050)
1.0	≤ 2	17500	0.030 (0.010—0.050)	14300	0.030 (0.010—0.050)	12700	0.030 (0.010—0.050)
1.5	≤ 2	12200	0.035 (0.015—0.055)	10000	0.035 (0.015—0.055)	8400	0.035 (0.015—0.050)
2.0	≤ 2	9500	0.040 (0.020—0.060)	7900	0.040 (0.020—0.060)	6700	0.040 (0.020—0.060)
2.5	≤ 2	7900	0.050 (0.030—0.070)	6600	0.050 (0.030—0.070)	5700	0.050 (0.030—0.070)
2.95	≤ 2	7900	0.060 (0.040—0.080)	7900	0.060 (0.040—0.080)	6800	0.060 (0.040—0.080)

Обрабатываемый материал		M		K			
		Аустенитная нержавеющая сталь ($\leq 200\text{HB}$) DIN X5CrNi189, X5CrNiMo1810 и т. д.		Серый чугун ($\leq 350\text{MPa}$) DIN GG30 и т. д.		Ковкий чугун ($\leq 450\text{MPa}$) DIN GGG40.3 и т. д.	
Диам. сверла DC (мм)	L/D	Частота вращения (мин ⁻¹)	$\alpha=0^\circ$ Подача (мин.—макс.) (мм/об)	Частота вращения (мин ⁻¹)	$\alpha=0^\circ$ Подача (мин.—макс.) (мм/об)	Частота вращения (мин ⁻¹)	$\alpha=0^\circ$ Подача (мин.—макс.) (мм/об)
0.75	≤ 2	10600	0.007 (0.003—0.011)	23300	0.030 (0.010—0.050)	16900	0.010 (0.005—0.015)
1.0	≤ 2	7900	0.007 (0.003—0.011)	17500	0.030 (0.010—0.050)	12700	0.010 (0.005—0.015)
1.5	≤ 2	5300	0.010 (0.005—0.015)	12200	0.035 (0.015—0.055)	10000	0.020 (0.010—0.030)
2.0	≤ 2	4700	0.015 (0.010—0.020)	9500	0.040 (0.020—0.060)	8700	0.030 (0.015—0.045)
2.5	≤ 2	3800	0.015 (0.010—0.020)	7900	0.050 (0.030—0.070)	7300	0.045 (0.025—0.065)
2.95	≤ 2	3100	0.020 (0.010—0.030)	7900	0.060 (0.040—0.080)	6800	0.050 (0.040—0.060)

Обрабатываемый материал		N	
		Алюминиевые сплавы (Si<5%) JIS A6061, A7075 и т. д.	
Диам. сверла DC (мм)	L/D	Частота вращения (мин ⁻¹)	$\alpha=0^\circ$ Подача (мин.—макс.) (мм/об)
0.75	≤ 2	42400	0.020 (0.010—0.030)
1.0	≤ 2	31800	0.020 (0.010—0.030)
1.5	≤ 2	21200	0.020 (0.010—0.030)
2.0	≤ 2	17500	0.050 (0.030—0.070)
2.5	≤ 2	14000	0.060 (0.040—0.090)
2.95	≤ 2	11600	0.060 (0.040—0.090)

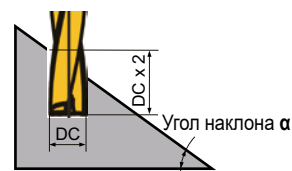

Примечание 1) рекомендуемая глубина отверстия составляет DCx2. Это расстояние измеряется как глубина от самой верхней точки поверхности обрабатываемого материала при работе на наклонных поверхностях (см. рисунок).

Примечание 2) в таблице выше приведены данные для сверления на плоской поверхности.

При сверлении отверстий на наклонных поверхностях следует настраивать скорость подачи в соответствии с углом наклона.

Если угол наклона α меньше или равен 30° , установите скорость подачи на уровне 70 % от рекомендованного значения или ниже.

Если угол наклона α больше или равен 30° , установите скорость подачи на уровне 50 % от рекомендованного значения или ниже.

Примечание 3) этот инструмент предназначен для сверления отверстий. Его нельзя использовать для поперечной обработки и винтовой интерполяции.

M

ИНСТРУМЕНТ ДЛЯ
СВЕРЛЕНИЯ

ИНСТРУМЕНТ ДЛЯ СВЕРЛЕНИЯ (МОНОЛИТНЫЕ ТВЕРДОСПЛАВНЫЕ СВЕРЛА)

ТВЕРДЫЙ СПЛАВ

MINI-DWAE

NEW

Мелкогабаритные



DC<2.0

- P
- M
- K
- N
- S
- H

Наружное охлаждение



DC<2.0

DC≥2.0

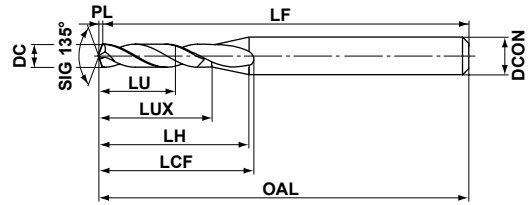

Тип 1

M

ИНСТРУМЕНТ ДЛЯ СВЕРЛЕНИЯ



DC ≤ 3	
⁰	
^{-0.014}	



DCON=3	DCON=4
⁰	⁰
^{-0.006}	^{-0.008}

DC (мм)	Глубина сверления (L/D)	DP102A	Обозначение	Размеры (мм)								Тип
				LU	LUX	LCF	LH	OAL	LF	PL	DCON	
1.0	2	●	DWAE0100X02S030	2.2	5.0	7.7	8.7	45.0	44.8	0.2	3	1
1.0	4	●	DWAE0100X04S030	4.2	7.0	9.9	10.7	45.0	44.8	0.2	3	1
1.1	2	★	DWAE0110X02S030	2.4	5.4	8.1	8.9	45.0	44.8	0.2	3	1
1.1	4	★	DWAE0110X04S030	4.6	7.6	10.5	11.1	45.0	44.8	0.2	3	1
1.2	2	★	DWAE0120X02S030	2.6	5.8	8.5	9.2	45.0	44.8	0.2	3	1
1.2	4	★	DWAE0120X04S030	5.0	8.2	11.1	11.6	45.0	44.8	0.2	3	1
1.3	2	★	DWAE0130X02S030	2.9	6.3	9.0	9.5	45.0	44.7	0.3	3	1
1.3	4	★	DWAE0130X04S030	5.5	8.9	11.9	12.1	45.0	44.7	0.3	3	1
1.4	2	★	DWAE0140X02S030	3.1	6.7	9.4	9.7	45.0	44.7	0.3	3	1
1.4	4	★	DWAE0140X04S030	5.9	9.5	12.5	12.5	45.0	44.7	0.3	3	1
1.5	2	●	DWAE0150X02S030	3.3	7.1	9.8	9.9	45.0	44.7	0.3	3	1
1.5	4	●	DWAE0150X04S030	6.3	10.1	13.1	12.9	45.0	44.7	0.3	3	1
1.6	2	★	DWAE0160X02S030	3.5	7.5	10.2	10.1	45.0	44.7	0.3	3	1
1.6	4	★	DWAE0160X04S030	6.7	10.7	13.7	13.3	45.0	44.7	0.3	3	1
1.7	2	★	DWAE0170X02S030	3.8	8.0	10.7	10.4	45.0	44.6	0.4	3	1
1.7	4	★	DWAE0170X04S030	7.2	11.4	14.4	13.8	45.0	44.6	0.4	3	1
1.8	2	★	DWAE0180X02S030	4.0	8.4	11.1	10.6	45.0	44.6	0.4	3	1
1.8	4	★	DWAE0180X04S030	7.6	12.0	15.1	14.2	45.0	44.6	0.4	3	1
1.9	2	★	DWAE0190X02S030	4.2	8.8	11.5	10.9	45.0	44.6	0.4	3	1
1.9	4	★	DWAE0190X04S030	8.0	12.6	15.7	14.7	45.0	44.6	0.4	3	1
2.0	2	●	DWAE0200X02S040	4.4	9.2	12.8	12.9	50.0	49.6	0.4	4	1
2.0	4	●	DWAE0200X04S040	8.4	13.2	17.2	16.9	50.0	49.6	0.4	4	1
2.1	2	★	DWAE0210X02S040	4.6	9.6	13.2	13.1	50.0	49.6	0.4	4	1
2.1	4	★	DWAE0210X04S040	8.8	13.8	17.8	17.3	50.0	49.6	0.4	4	1
2.2	2	★	DWAE0220X02S040	4.9	10.1	13.7	13.5	50.0	49.5	0.5	4	1
2.2	4	★	DWAE0220X04S040	9.3	14.5	18.5	17.9	50.0	49.5	0.5	4	1
2.3	2	★	DWAE0230X02S040	5.1	10.5	14.1	13.7	50.0	49.5	0.5	4	1
2.3	4	★	DWAE0230X04S040	9.7	15.1	19.2	18.3	50.0	49.5	0.5	4	1
2.4	2	★	DWAE0240X02S040	5.3	10.9	14.5	13.9	50.0	49.5	0.5	4	1
2.4	4	★	DWAE0240X04S040	10.1	15.7	19.8	18.7	50.0	49.5	0.5	4	1
2.5	2	●	DWAE0250X02S040	5.5	11.3	14.9	14.1	50.0	49.5	0.5	4	1
2.5	4	●	DWAE0250X04S040	10.5	16.3	20.4	19.1	50.0	49.5	0.5	4	1
2.6	2	★	DWAE0260X02S040	5.7	11.7	15.3	14.3	50.0	49.5	0.5	4	1
2.6	4	★	DWAE0260X04S040	10.9	16.9	21.0	19.5	50.0	49.5	0.5	4	1
2.7	2	★	DWAE0270X02S040	6.0	12.2	15.8	14.6	50.0	49.4	0.6	4	1
2.7	4	★	DWAE0270X04S040	11.4	17.6	21.7	20.0	50.0	49.4	0.6	4	1
2.8	2	★	DWAE0280X02S040	6.2	12.6	16.2	14.8	50.0	49.4	0.6	4	1
2.8	4	★	DWAE0280X04S040	11.8	18.2	22.4	20.4	50.0	49.4	0.6	4	1
2.9	2	★	DWAE0290X02S040	6.4	13.0	16.6	15.1	50.0	49.4	0.6	4	1
2.9	4	★	DWAE0290X04S040	12.2	18.8	23.0	20.9	50.0	49.4	0.6	4	1

● : Есть на складе. ★ : Со склада в Японии.

M020

P
M
K
N
S
H

Наружное охлаждение

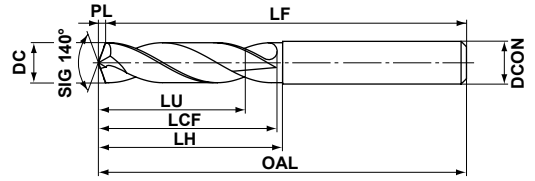

Тип 1



DC=3	3<DC≤6	6<DC≤10	10<DC≤14
$\begin{matrix} 0 \\ -0.014 \end{matrix}$	$\begin{matrix} 0 \\ -0.018 \end{matrix}$	$\begin{matrix} 0 \\ -0.022 \end{matrix}$	$\begin{matrix} 0 \\ -0.027 \end{matrix}$



DCON=3	3<DCON≤6	6<DCON≤10	10<DCON≤14
$\begin{matrix} 0 \\ -0.006 \end{matrix}$	$\begin{matrix} 0 \\ -0.008 \end{matrix}$	$\begin{matrix} 0 \\ -0.009 \end{matrix}$	$\begin{matrix} 0 \\ -0.011 \end{matrix}$

DC (мм)	Глубина сверления (L/D)	DP102A	Обозначение	Размеры (мм)							Тип
				LU	LCF	LH	OAL	LF	PL	DCON	
3.0	2	●	DWAE0300X02S030	6.5	12.5	14.5	45.5	45	0.5	3	1
3.0	4	●	DWAE0300X04S030	12.5	21.5	23.5	55.5	55	0.5	3	1
3.1	2	●	DWAE0310X02S040	6.8	12.6	14.6	55.6	55	0.6	4	1
3.1	4	●	DWAE0310X04S040	13.0	21.6	23.6	60.6	60	0.6	4	1
3.2	2	●	DWAE0320X02S040	7.0	13.6	15.6	55.6	55	0.6	4	1
3.2	4	●	DWAE0320X04S040	13.4	22.6	24.6	60.6	60	0.6	4	1
3.3	2	●	DWAE0330X02S040	7.2	13.6	15.6	55.6	55	0.6	4	1
3.3	4	●	DWAE0330X04S040	13.8	23.6	25.6	60.6	60	0.6	4	1
3.4	2	●	DWAE0340X02S040	7.4	13.6	15.6	55.6	55	0.6	4	1
3.4	4	●	DWAE0340X04S040	14.2	23.6	25.6	60.6	60	0.6	4	1
3.5	2	●	DWAE0350X02S040	7.6	14.6	16.6	55.6	55	0.6	4	1
3.5	4	●	DWAE0350X04S040	14.6	24.6	26.6	60.6	60	0.6	4	1
3.6	2	●	DWAE0360X02S040	7.9	14.7	16.7	55.7	55	0.7	4	1
3.6	4	●	DWAE0360X04S040	15.1	25.7	27.7	60.7	60	0.7	4	1
3.7	2	●	DWAE0370X02S040	8.1	14.7	16.7	55.7	55	0.7	4	1
3.7	4	●	DWAE0370X04S040	15.5	25.7	27.7	60.7	60	0.7	4	1
3.8	2	●	DWAE0380X02S040	8.3	15.7	17.7	55.7	55	0.7	4	1
3.8	4	●	DWAE0380X04S040	15.9	26.7	28.7	60.7	60	0.7	4	1
3.9	2	●	DWAE0390X02S040	8.5	15.7	17.7	55.7	55	0.7	4	1
3.9	4	●	DWAE0390X04S040	16.3	27.7	29.7	60.7	60	0.7	4	1
4.0	2	●	DWAE0400X02S040	8.7	15.7	17.7	55.7	55	0.7	4	1
4.0	4	●	DWAE0400X04S040	16.7	27.7	29.7	60.7	60	0.7	4	1
4.1	2	●	DWAE0410X02S050	8.9	16.7	18.7	62.7	62	0.7	5	1
4.1	4	●	DWAE0410X04S050	17.1	28.7	30.7	80.7	80	0.7	5	1
4.2	2	●	DWAE0420X02S050	9.2	16.8	18.8	62.8	62	0.8	5	1
4.2	4	●	DWAE0420X04S050	17.6	29.8	31.8	80.8	80	0.8	5	1
4.3	2	●	DWAE0430X02S050	9.4	17.8	19.8	62.8	62	0.8	5	1
4.3	4	●	DWAE0430X04S050	18.0	30.8	32.8	80.8	80	0.8	5	1
4.4	2	●	DWAE0440X02S050	9.6	17.8	19.8	62.8	62	0.8	5	1
4.4	4	●	DWAE0440X04S050	18.4	30.8	32.8	80.8	80	0.8	5	1

ИНСТРУМЕНТ ДЛЯ СВЕРЛЕНИЯ (МОНОЛИТНЫЕ ТВЕРДОСПЛАВНЫЕ СВЕРЛА)

DWAE

NEW

 ТВЕРДЫЙ
СПЛАВ

M

 ИНСТРУМЕНТ ДЛЯ
СВЕРЛЕНИЯ

DC (мм)	Глубина сверления (L/D)	DP-102A	Обозначение	Размеры (мм)							Тип
				LU	LCF	LH	OAL	LF	PL	DCON	
4.5	2	●	DWAE0450X02S050	9.8	17.8	19.8	62.8	62	0.8	5	1
4.5	4	●	DWAE0450X04S050	18.8	31.8	33.8	80.8	80	0.8	5	1
4.6	2	●	DWAE0460X02S050	10.0	18.8	20.8	62.8	62	0.8	5	1
4.6	4	●	DWAE0460X04S050	19.2	32.8	34.8	80.8	80	0.8	5	1
4.7	2	●	DWAE0470X02S050	10.3	18.9	20.9	62.9	62	0.9	5	1
4.7	4	●	DWAE0470X04S050	19.7	32.9	34.9	80.9	80	0.9	5	1
4.8	2	●	DWAE0480X02S050	10.5	18.9	20.9	62.9	62	0.9	5	1
4.8	4	●	DWAE0480X04S050	20.1	33.9	35.9	80.9	80	0.9	5	1
4.9	2	●	DWAE0490X02S050	10.7	19.9	21.9	62.9	62	0.9	5	1
4.9	4	●	DWAE0490X04S050	20.5	34.9	36.9	80.9	80	0.9	5	1
5.0	2	●	DWAE0500X02S050	10.9	19.9	21.9	62.9	62	0.9	5	1
5.0	4	●	DWAE0500X04S050	20.9	34.9	36.9	80.9	80	0.9	5	1
5.1	2	★	DWAE0510X02S060	11.1	21.9	23.9	66.9	66	0.9	6	1
5.1	4	★	DWAE0510X04S060	21.3	35.9	37.9	80.9	80	0.9	6	1
5.2	2	●	DWAE0520X02S060	11.3	21.9	23.9	66.9	66	0.9	6	1
5.2	4	●	DWAE0520X04S060	21.7	36.9	38.9	80.9	80	0.9	6	1
5.3	2	★	DWAE0530X02S060	11.6	22.0	24.0	67.0	66	1.0	6	1
5.3	4	★	DWAE0530X04S060	22.2	37.0	39.0	81.0	80	1.0	6	1
5.4	2	●	DWAE0540X02S060	11.8	22.0	24.0	67.0	66	1.0	6	1
5.4	4	●	DWAE0540X04S060	22.6	38.0	40.0	81.0	80	1.0	6	1
5.5	2	★	DWAE0550X02S060	12.0	22.0	24.0	67.0	66	1.0	6	1
5.5	4	★	DWAE0550X04S060	23.0	39.0	41.0	81.0	80	1.0	6	1
5.6	2	●	DWAE0560X02S060	12.2	24.0	26.0	67.0	66	1.0	6	1
5.6	4	●	DWAE0560X04S060	23.4	39.0	41.0	81.0	80	1.0	6	1
5.7	2	★	DWAE0570X02S060	12.4	24.0	26.0	67.0	66	1.0	6	1
5.7	4	★	DWAE0570X04S060	23.8	39.0	41.0	81.0	80	1.0	6	1
5.8	2	●	DWAE0580X02S060	12.7	24.1	26.1	67.1	66	1.1	6	1
5.8	4	●	DWAE0580X04S060	24.3	41.1	43.1	81.1	80	1.1	6	1
5.9	2	★	DWAE0590X02S060	12.9	24.1	26.1	67.1	66	1.1	6	1
5.9	4	★	DWAE0590X04S060	24.7	41.1	43.1	81.1	80	1.1	6	1
6.0	2	●	DWAE0600X02S060	13.1	24.1	26.1	67.1	66	1.1	6	1
6.0	4	●	DWAE0600X04S060	25.1	42.1	44.1	81.1	80	1.1	6	1
6.1	2	★	DWAE0610X02S070	13.3	26.1	28.1	75.1	74	1.1	7	1
6.1	4	★	DWAE0610X04S070	25.5	44.1	46.1	84.1	83	1.1	7	1
6.2	2	●	DWAE0620X02S070	13.5	26.1	28.1	75.1	74	1.1	7	1
6.2	4	●	DWAE0620X04S070	25.9	44.1	46.1	84.1	83	1.1	7	1
6.3	2	★	DWAE0630X02S070	13.7	26.1	28.1	75.1	74	1.1	7	1
6.3	4	★	DWAE0630X04S070	26.3	44.1	46.1	84.1	83	1.1	7	1
6.4	2	●	DWAE0640X02S070	14.0	26.2	28.2	75.2	74	1.2	7	1
6.4	4	●	DWAE0640X04S070	26.8	44.2	46.2	84.2	83	1.2	7	1
6.5	2	★	DWAE0650X02S070	14.2	26.2	28.2	75.2	74	1.2	7	1
6.5	4	★	DWAE0650X04S070	27.2	44.2	46.2	84.2	83	1.2	7	1

● : Есть на складе. ★ : Со склада в Японии.

DC (мм)	Глубина сверления (L/D)	DP-102A	Обозначение	Размеры (мм)							Тип
				LU	LCF	LH	OAL	LF	PL	DCON	
6.6	2	●	DWAE0660X02S070	14.4	28.2	30.2	75.2	74	1.2	7	1
6.6	4	●	DWAE0660X04S070	27.6	46.2	48.2	84.2	83	1.2	7	1
6.7	2	★	DWAE0670X02S070	14.6	28.2	30.2	75.2	74	1.2	7	1
6.7	4	★	DWAE0670X04S070	28.0	46.2	48.2	84.2	83	1.2	7	1
6.8	2	●	DWAE0680X02S070	14.8	28.2	30.2	75.2	74	1.2	7	1
6.8	4	●	DWAE0680X04S070	28.4	46.2	48.2	84.2	83	1.2	7	1
6.9	2	★	DWAE0690X02S070	15.1	28.3	30.3	75.3	74	1.3	7	1
6.9	4	★	DWAE0690X04S070	28.9	46.3	48.3	84.3	83	1.3	7	1
7.0	2	●	DWAE0700X02S070	15.3	28.3	30.3	75.3	74	1.3	7	1
7.0	4	●	DWAE0700X04S070	29.3	46.3	48.3	84.3	83	1.3	7	1
7.1	2	★	DWAE0710X02S080	15.5	29.3	31.3	80.3	79	1.3	8	1
7.1	4	★	DWAE0710X04S080	29.7	51.3	53.3	91.3	90	1.3	8	1
7.2	2	●	DWAE0720X02S080	15.7	29.3	31.3	80.3	79	1.3	8	1
7.2	4	●	DWAE0720X04S080	30.1	51.3	53.3	91.3	90	1.3	8	1
7.3	2	★	DWAE0730X02S080	15.9	29.3	31.3	80.3	79	1.3	8	1
7.3	4	★	DWAE0730X04S080	30.5	51.3	53.3	91.3	90	1.3	8	1
7.4	2	●	DWAE0740X02S080	16.1	29.3	31.3	80.3	79	1.3	8	1
7.4	4	●	DWAE0740X04S080	30.9	51.3	53.3	91.3	90	1.3	8	1
7.5	2	★	DWAE0750X02S080	16.4	29.4	31.4	80.4	79	1.4	8	1
7.5	4	★	DWAE0750X04S080	31.4	51.4	53.4	91.4	90	1.4	8	1
7.6	2	●	DWAE0760X02S080	16.6	31.4	33.4	80.4	79	1.4	8	1
7.6	4	●	DWAE0760X04S080	31.8	53.4	55.4	91.4	90	1.4	8	1
7.7	2	★	DWAE0770X02S080	16.8	31.4	33.4	80.4	79	1.4	8	1
7.7	4	★	DWAE0770X04S080	32.2	53.4	55.4	91.4	90	1.4	8	1
7.8	2	●	DWAE0780X02S080	17.0	31.4	33.4	80.4	79	1.4	8	1
7.8	4	●	DWAE0780X04S080	32.6	53.4	55.4	91.4	90	1.4	8	1
7.9	2	★	DWAE0790X02S080	17.2	31.4	33.4	80.4	79	1.4	8	1
7.9	4	★	DWAE0790X04S080	33.0	53.4	55.4	91.4	90	1.4	8	1
8.0	2	●	DWAE0800X02S080	17.5	31.5	33.5	80.5	79	1.5	8	1
8.0	4	●	DWAE0800X04S080	33.5	53.5	55.5	91.5	90	1.5	8	1
8.1	2	★	DWAE0810X02S090	17.7	33.5	35.5	85.5	84	1.5	9	1
8.1	4	★	DWAE0810X04S090	33.9	57.5	59.5	99.5	98	1.5	9	1
8.2	2	●	DWAE0820X02S090	17.9	33.5	35.5	85.5	84	1.5	9	1
8.2	4	●	DWAE0820X04S090	34.3	57.5	59.5	99.5	98	1.5	9	1
8.3	2	★	DWAE0830X02S090	18.1	33.5	35.5	85.5	84	1.5	9	1
8.3	4	★	DWAE0830X04S090	34.7	57.5	59.5	99.5	98	1.5	9	1
8.4	2	●	DWAE0840X02S090	18.3	33.5	35.5	85.5	84	1.5	9	1
8.4	4	●	DWAE0840X04S090	35.1	57.5	59.5	99.5	98	1.5	9	1
8.5	2	★	DWAE0850X02S090	18.5	33.5	35.5	85.5	84	1.5	9	1
8.5	4	★	DWAE0850X04S090	35.5	57.5	59.5	99.5	98	1.5	9	1
8.6	2	●	DWAE0860X02S090	18.8	34.6	36.6	85.6	84	1.6	9	1
8.6	4	●	DWAE0860X04S090	36.0	61.6	63.6	99.6	98	1.6	9	1
8.7	2	★	DWAE0870X02S090	19.0	34.6	36.6	85.6	84	1.6	9	1
8.7	4	★	DWAE0870X04S090	36.4	61.6	63.6	99.6	98	1.6	9	1

ИНСТРУМЕНТ ДЛЯ СВЕРЛЕНИЯ (МОНОЛИТНЫЕ ТВЕРДОСПЛАВНЫЕ СВЕРЛА)

DWAE

NEW

 ТВЕРДЫЙ
СПЛАВ

M

 ИНСТРУМЕНТ ДЛЯ
СВЕРЛЕНИЯ

DC (мм)	Глубина сверления (L/D)	DP-102A	Обозначение	Размеры (мм)							Тип
				LU	LCF	LH	OAL	LF	PL	DCON	
8.8	2	●	DWAE0880X02S090	19.2	34.6	36.6	85.6	84	1.6	9	1
8.8	4	●	DWAE0880X04S090	36.8	61.6	63.6	99.6	98	1.6	9	1
8.9	2	★	DWAE0890X02S090	19.4	34.6	36.6	85.6	84	1.6	9	1
8.9	4	★	DWAE0890X04S090	37.2	61.6	63.6	99.6	98	1.6	9	1
9.0	2	●	DWAE0900X02S090	19.6	34.6	36.6	85.6	84	1.6	9	1
9.0	4	●	DWAE0900X04S090	37.6	61.6	63.6	99.6	98	1.6	9	1
9.1	2	★	DWAE0910X02S100	19.9	36.7	38.7	90.7	89	1.7	10	1
9.1	4	★	DWAE0910X04S100	38.1	63.7	65.7	106.7	105	1.7	10	1
9.2	2	●	DWAE0920X02S100	20.1	36.7	38.7	90.7	89	1.7	10	1
9.2	4	●	DWAE0920X04S100	38.5	63.7	65.7	106.7	105	1.7	10	1
9.3	2	★	DWAE0930X02S100	20.3	36.7	38.7	90.7	89	1.7	10	1
9.3	4	★	DWAE0930X04S100	38.9	63.7	65.7	106.7	105	1.7	10	1
9.4	2	●	DWAE0940X02S100	20.5	36.7	38.7	90.7	89	1.7	10	1
9.4	4	●	DWAE0940X04S100	39.3	63.7	65.7	106.7	105	1.7	10	1
9.5	2	★	DWAE0950X02S100	20.7	36.7	38.7	90.7	89	1.7	10	1
9.5	4	★	DWAE0950X04S100	39.7	63.7	65.7	106.7	105	1.7	10	1
9.6	2	●	DWAE0960X02S100	20.9	37.7	39.7	90.7	89	1.7	10	1
9.6	4	●	DWAE0960X04S100	40.1	66.7	68.7	106.7	105	1.7	10	1
9.7	2	★	DWAE0970X02S100	21.2	37.8	39.8	90.8	89	1.8	10	1
9.7	4	★	DWAE0970X04S100	40.6	66.8	68.8	106.8	105	1.8	10	1
9.8	2	●	DWAE0980X02S100	21.4	37.8	39.8	90.8	89	1.8	10	1
9.8	4	●	DWAE0980X04S100	41.0	66.8	68.8	106.8	105	1.8	10	1
9.9	2	★	DWAE0990X02S100	21.6	37.8	39.8	90.8	89	1.8	10	1
9.9	4	★	DWAE0990X04S100	41.4	66.8	68.8	106.8	105	1.8	10	1
10.0	2	●	DWAE1000X02S100	21.8	37.8	39.8	90.8	89	1.8	10	1
10.0	4	●	DWAE1000X04S100	41.8	66.8	68.8	106.8	105	1.8	10	1
10.1	2	●	DWAE1010X02S110	22.0	40.8	42.8	101.8	100	1.8	11	1
10.1	4	●	DWAE1010X04S110	42.2	71.8	73.8	115.8	114	1.8	11	1
10.2	2	●	DWAE1020X02S110	22.3	40.9	42.9	101.9	100	1.9	11	1
10.2	4	●	DWAE1020X04S110	42.7	71.9	73.9	115.9	114	1.9	11	1
10.3	2	●	DWAE1030X02S110	22.5	40.9	42.9	101.9	100	1.9	11	1
10.3	4	●	DWAE1030X04S110	43.1	71.9	73.9	115.9	114	1.9	11	1
10.4	2	●	DWAE1040X02S110	22.7	40.9	42.9	101.9	100	1.9	11	1
10.4	4	●	DWAE1040X04S110	43.5	71.9	73.9	115.9	114	1.9	11	1
10.5	2	●	DWAE1050X02S110	22.9	40.9	42.9	101.9	100	1.9	11	1
10.5	4	●	DWAE1050X04S110	43.9	71.9	73.9	115.9	114	1.9	11	1
10.6	2	●	DWAE1060X02S110	23.1	41.9	43.9	101.9	100	1.9	11	1
10.6	4	●	DWAE1060X04S110	44.3	72.9	74.9	115.9	114	1.9	11	1
10.7	2	●	DWAE1070X02S110	23.3	41.9	43.9	101.9	100	1.9	11	1
10.7	4	●	DWAE1070X04S110	44.7	72.9	74.9	115.9	114	1.9	11	1
10.8	2	●	DWAE1080X02S110	23.6	42.0	44.0	102.0	100	2.0	11	1
10.8	4	●	DWAE1080X04S110	45.2	73.0	75.0	116.0	114	2.0	11	1

● : Есть на складе. ★ : Со склада в Японии.

DC (мм)	Глубина сверления (L/D)	DP-102A	Обозначение	Размеры (мм)							Тип
				LU	LCF	LH	OAL	LF	PL	DCON	
10.9	2	●	DWAE1090X02S110	23.8	42.0	44.0	102.0	100	2.0	11	1
10.9	4	●	DWAE1090X04S110	45.6	73.0	75.0	116.0	114	2.0	11	1
11.0	2	●	DWAE1100X02S110	24.0	42.0	44.0	102.0	100	2.0	11	1
11.0	4	●	DWAE1100X04S110	46.0	73.0	75.0	116.0	114	2.0	11	1
11.1	2	●	DWAE1110X02S120	24.2	45.0	47.0	102.0	100	2.0	12	1
11.1	4	●	DWAE1110X04S120	46.4	77.0	79.0	123.0	121	2.0	12	1
11.2	2	●	DWAE1120X02S120	24.4	45.0	47.0	102.0	100	2.0	12	1
11.2	4	●	DWAE1120X04S120	46.8	77.0	79.0	123.0	121	2.0	12	1
11.3	2	●	DWAE1130X02S120	24.7	45.1	47.1	102.1	100	2.1	12	1
11.3	4	●	DWAE1130X04S120	47.3	77.1	79.1	123.1	121	2.1	12	1
11.4	2	●	DWAE1140X02S120	24.9	45.1	47.1	102.1	100	2.1	12	1
11.4	4	●	DWAE1140X04S120	47.7	77.1	79.1	123.1	121	2.1	12	1
11.5	2	●	DWAE1150X02S120	25.1	45.1	47.1	102.1	100	2.1	12	1
11.5	4	●	DWAE1150X04S120	48.1	77.1	79.1	123.1	121	2.1	12	1
11.6	2	●	DWAE1160X02S120	25.3	47.1	49.1	102.1	100	2.1	12	1
11.6	4	●	DWAE1160X04S120	48.5	79.1	81.1	123.1	121	2.1	12	1
11.7	2	●	DWAE1170X02S120	25.5	47.1	49.1	102.1	100	2.1	12	1
11.7	4	●	DWAE1170X04S120	48.9	79.1	81.1	123.1	121	2.1	12	1
11.8	2	●	DWAE1180X02S120	25.7	47.1	49.1	102.1	100	2.1	12	1
11.8	4	●	DWAE1180X04S120	49.3	79.1	81.1	123.1	121	2.1	12	1
11.9	2	●	DWAE1190X02S120	26.0	47.2	49.2	102.2	100	2.2	12	1
11.9	4	●	DWAE1190X04S120	49.8	79.2	81.2	123.2	121	2.2	12	1
12.0	2	●	DWAE1200X02S120	26.2	47.2	49.2	102.2	100	2.2	12	1
12.0	4	●	DWAE1200X04S120	50.2	79.2	81.2	123.2	121	2.2	12	1
12.1	2	●	DWAE1210X02S130	26.4	49.2	51.2	102.2	100	2.2	13	1
12.1	4	●	DWAE1210X04S130	50.6	82.2	84.2	139.2	137	2.2	13	1
12.2	2	●	DWAE1220X02S130	26.6	49.2	51.2	102.2	100	2.2	13	1
12.2	4	●	DWAE1220X04S130	51.0	82.2	84.2	139.2	137	2.2	13	1
12.3	2	●	DWAE1230X02S130	26.8	49.2	51.2	102.2	100	2.2	13	1
12.3	4	●	DWAE1230X04S130	51.4	82.2	84.2	139.2	137	2.2	13	1
12.4	2	●	DWAE1240X02S130	27.1	49.3	51.3	102.3	100	2.3	13	1
12.4	4	●	DWAE1240X04S130	51.9	82.3	84.3	139.3	137	2.3	13	1
12.5	2	●	DWAE1250X02S130	27.3	49.3	51.3	102.3	100	2.3	13	1
12.5	4	●	DWAE1250X04S130	52.3	82.3	84.3	139.3	137	2.3	13	1
12.6	2	●	DWAE1260X02S130	27.5	52.3	54.3	102.3	100	2.3	13	1
12.6	4	●	DWAE1260X04S130	52.7	84.3	86.3	139.3	137	2.3	13	1
12.7	2	●	DWAE1270X02S130	27.7	52.3	54.3	102.3	100	2.3	13	1
12.7	4	●	DWAE1270X04S130	53.1	84.3	86.3	139.3	137	2.3	13	1
12.8	2	●	DWAE1280X02S130	27.9	52.3	54.3	102.3	100	2.3	13	1
12.8	4	●	DWAE1280X04S130	53.5	84.3	86.3	139.3	137	2.3	13	1
12.9	2	●	DWAE1290X02S130	28.1	52.3	54.3	102.3	100	2.3	13	1
12.9	4	●	DWAE1290X04S130	53.9	84.3	86.3	139.3	137	2.3	13	1

ИНСТРУМЕНТ ДЛЯ СВЕРЛЕНИЯ (МОНОЛИТНЫЕ ТВЕРДОСПЛАВНЫЕ СВЕРЛА)

DWAE

NEW

 ТВЕРДЫЙ
СПЛАВ

M

 ИНСТРУМЕНТ ДЛЯ
СВЕРЛЕНИЯ

DC (мм)	Глубина сверления (L/D)	DP102A	Обозначение	Размеры (мм)							Тип
				LU	LCF	LH	OAL	LF	PL	DCON	
13.0	2	●	DWAE1300X02S130	28.4	52.4	54.4	102.4	100	2.4	13	1
13.0	4	●	DWAE1300X04S130	54.4	84.4	86.4	139.4	137	2.4	13	1
13.1	2	●	DWAE1310X02S140	28.6	55.4	57.4	102.4	100	2.4	14	1
13.1	4	●	DWAE1310X04S140	54.8	92.4	94.4	149.4	147	2.4	14	1
13.2	2	●	DWAE1320X02S140	28.8	55.4	57.4	102.4	100	2.4	14	1
13.2	4	●	DWAE1320X04S140	55.2	92.4	94.4	149.4	147	2.4	14	1
13.3	2	●	DWAE1330X02S140	29.0	55.4	57.4	102.4	100	2.4	14	1
13.3	4	●	DWAE1330X04S140	55.6	92.4	94.4	149.4	147	2.4	14	1
13.4	2	●	DWAE1340X02S140	29.2	55.4	57.4	102.4	100	2.4	14	1
13.4	4	●	DWAE1340X04S140	56.0	92.4	94.4	149.4	147	2.4	14	1
13.5	2	●	DWAE1350X02S140	29.5	55.5	57.5	102.5	100	2.5	14	1
13.5	4	●	DWAE1350X04S140	56.5	92.5	94.5	149.5	147	2.5	14	1
13.6	2	●	DWAE1360X02S140	29.7	57.5	59.5	102.5	100	2.5	14	1
13.6	4	●	DWAE1360X04S140	56.9	97.5	99.5	149.5	147	2.5	14	1
13.7	2	●	DWAE1370X02S140	29.9	57.5	59.5	102.5	100	2.5	14	1
13.7	4	●	DWAE1370X04S140	57.3	97.5	99.5	149.5	147	2.5	14	1
13.8	2	●	DWAE1380X02S140	30.1	57.5	59.5	102.5	100	2.5	14	1
13.8	4	●	DWAE1380X04S140	57.7	97.5	99.5	149.5	147	2.5	14	1
13.9	2	●	DWAE1390X02S140	30.3	57.5	59.5	102.5	100	2.5	14	1
13.9	4	●	DWAE1390X04S140	58.1	97.5	99.5	149.5	147	2.5	14	1
14.0	2	●	DWAE1400X02S140	30.5	57.5	59.5	102.5	100	2.5	14	1
14.0	4	●	DWAE1400X04S140	58.5	97.5	99.5	149.5	147	2.5	14	1

● : Есть на складе.

РЕКОМЕНДУЕМЫЕ РЕЖИМЫ РЕЗАНИЯ

Обрабатываемый материал	P							
	Малоуглеродистые стали ($\leq 180\text{HB}$)				Углеродистые стали, легированные стали ($180-250\text{HB}$)			
	EU S275JR, S355 и т. д.				C45, 42CrMo4 и т. д.			
Диам. сверла DC (мм)	Скорость резания (м/мин)	Частота вращения (мин^{-1})	Подача (мин. — макс.) (мм/об)	Подача (мм/мин)	Скорость резания (м/мин)	Частота вращения (мин^{-1})	Подача (мин. — макс.) (мм/об)	Подача (мм/мин)
1.0	30	9500	0.03 (0.02—0.04)	285	30	9500	0.03 (0.02—0.04)	285
1.5	30	6300	0.05 (0.03—0.06)	315	30	6300	0.05 (0.03—0.06)	315
2.0	55	8700	0.06 (0.04—0.08)	520	55	8700	0.06 (0.04—0.08)	520
2.5	55	7000	0.08 (0.05—0.10)	560	55	7000	0.08 (0.05—0.10)	560
3.0	65	6800	0.09 (0.07—0.11)	610	60	6300	0.09 (0.07—0.11)	565
4.0	70	5500	0.12 (0.09—0.14)	660	65	5100	0.12 (0.09—0.14)	610
5.0	70	4400	0.15 (0.11—0.18)	660	65	4100	0.15 (0.11—0.18)	615
6.0	80	4200	0.18 (0.14—0.21)	755	75	3900	0.18 (0.14—0.21)	700
7.0	80	3600	0.21 (0.16—0.25)	755	75	3400	0.21 (0.16—0.25)	715
8.0	85	3300	0.23 (0.18—0.28)	760	80	3100	0.23 (0.18—0.28)	715
10.0	90	2800	0.27 (0.21—0.32)	755	85	2700	0.27 (0.21—0.32)	730
12.0	95	2500	0.28 (0.22—0.34)	700	90	2300	0.28 (0.22—0.34)	645
14.0	95	2100	0.29 (0.23—0.35)	610	90	2000	0.29 (0.23—0.35)	580

Обрабатываемый материал	P				M			
	Углеродистые стали, легированные стали ($280-350\text{HB}$)				Аустенитная нержавеющая сталь ($\leq 200\text{HB}$) Ферритные и мартенситные нержавеющие стали ($>200\text{HB}$)			
	40CrNiMo и т. д.				X12CrS13, X30Cr13 и т. д.			
Диам. сверла DC (мм)	Скорость резания (м/мин)	Частота вращения (мин^{-1})	Подача (мин. — макс.) (мм/об)	Подача (мм/мин)	Скорость резания (м/мин)	Частота вращения (мин^{-1})	Подача (мин. — макс.) (мм/об)	Подача (мм/мин)
1.0	25	7900	0.02 (0.01—0.03)	160	30	9500	0.02 (0.01—0.03)	190
1.5	25	5300	0.04 (0.02—0.05)	210	30	6300	0.04 (0.02—0.05)	250
2.0	50	7900	0.05 (0.03—0.07)	395	35	5500	0.04 (0.02—0.06)	220
2.5	50	6300	0.07 (0.04—0.09)	440	35	4400	0.06 (0.03—0.08)	265
3.0	55	5800	0.08 (0.06—0.09)	465	40	4200	0.07 (0.04—0.10)	295
4.0	60	4700	0.11 (0.08—0.13)	515	40	3100	0.08 (0.05—0.10)	250
5.0	60	3800	0.13 (0.10—0.16)	495	40	2500	0.10 (0.05—0.15)	250
6.0	70	3700	0.16 (0.12—0.19)	590	40	2100	0.11 (0.06—0.15)	230
7.0	70	3100	0.18 (0.14—0.22)	560	40	1800	0.12 (0.06—0.18)	215
8.0	75	2900	0.21 (0.16—0.25)	610	40	1500	0.13 (0.06—0.20)	195
10.0	80	2500	0.24 (0.20—0.28)	600	40	1200	0.14 (0.08—0.20)	170
12.0	85	2200	0.25 (0.20—0.30)	550	40	1000	0.18 (0.10—0.25)	180
14.0	85	1900	0.25 (0.20—0.30)	475	40	900	0.18 (0.10—0.25)	160

Примечание 1) Приведенные выше режимы резания применимы при использовании водоземлюсионной СОЖ. Для обработки нержавеющих сталей рекомендуется использовать нерастворимую в воде СОЖ.

Примечание 2) При использовании нерастворимой в воде СОЖ уменьшайте скорость резания на 20 %, чтобы обеспечить достаточную смазку.

Примечание 3) Проверьте состояние стружки и при необходимости выполните пошаговую обработку. * Рекомендованная длина шага: $0,2-1,0 DC$

Примечание 4) Отрегулируйте режимы резания в соответствии с жесткостью станка и надёжностью зажима заготовки, геометрией обработки и т. д.

Примечание 5) Не рекомендуется, чтобы глубина обработки превышала длину стружечной канавки (LU).

Примечание 6) Закрепляйте сверло так, чтобы биение сверла не превышало $0,03 \text{ мм}$.

Примечание 7) Не зажимайте часть сверла со стружечными канавками.

M

ИНСТРУМЕНТ ДЛЯ
СВЕРЛЕНИЯ

ИНСТРУМЕНТ ДЛЯ СВЕРЛЕНИЯ (МОНОЛИТНЫЕ ТВЕРДОСПЛАВНЫЕ СВЕРЛА)

ТВЕРДЫЙ
СПЛАВ

РЕКОМЕНДУЕМЫЕ РЕЖИМЫ РЕЗАНИЯ

Обрабатываемый материал	К							
	Серый чугун (≤ 350 МПа) GG30 и т. д.				Ковкий чугун (≤ 450 МПа) EN-GJS-450-10 и т. д.			
Диам. сверла DC (мм)	Скорость резания (м/мин)	Частота вращения (мин ⁻¹)	Подача (мин. — макс.) (мм/об)	Подача (мм/мин)	Скорость резания (м/мин)	Частота вращения (мин ⁻¹)	Подача (мин. — макс.) (мм/об)	Подача (мм/мин)
1.0	30	9500	0.03 (0.02—0.04)	285	25	7900	0.02 (0.01—0.03)	160
1.5	30	6300	0.05 (0.03—0.06)	315	25	5300	0.04 (0.02—0.05)	210
2.0	55	8700	0.06 (0.04—0.08)	520	50	7900	0.05 (0.03—0.07)	395
2.5	55	7000	0.08 (0.05—0.10)	560	50	6300	0.07 (0.04—0.09)	440
3.0	65	6800	0.09 (0.07—0.11)	610	55	5800	0.09 (0.05—0.12)	520
4.0	70	5500	0.12 (0.09—0.14)	660	60	4700	0.12 (0.07—0.17)	565
5.0	70	4400	0.15 (0.11—0.18)	660	60	3800	0.14 (0.08—0.20)	530
6.0	80	4200	0.18 (0.14—0.21)	755	70	3700	0.15 (0.10—0.20)	555
7.0	80	3600	0.21 (0.16—0.25)	755	70	3100	0.18 (0.12—0.23)	560
8.0	85	3300	0.23 (0.18—0.28)	760	75	2900	0.20 (0.15—0.25)	580
10.0	90	2800	0.27 (0.21—0.32)	755	80	2500	0.23 (0.18—0.28)	575
12.0	95	2500	0.28 (0.22—0.34)	700	85	2200	0.25 (0.20—0.30)	550
14.0	95	2100	0.29 (0.23—0.35)	610	85	1900	0.25 (0.20—0.30)	475

Примечание 1) Приведенные выше режимы резания применимы при использовании водоземulsionной СОЖ. Для обработки нержавеющей стали рекомендуется использовать нерастворимую в воде СОЖ.

Примечание 2) При использовании нерастворимой в воде СОЖ уменьшайте скорость резания на 20 %, чтобы обеспечить достаточную смазку.

Примечание 3) Проверьте состояние стружки и при необходимости выполните пошаговую обработку. * Рекомендованная длина шага: 0,2–1,0 DC

Примечание 4) Отрегулируйте режимы резания в соответствии с жесткостью станка и надёжностью зажима заготовки, геометрией обработки и т. д.

Примечание 5) Не рекомендуется, чтобы глубина обработки превышала длину стружечной канавки (LU).

Примечание 6) Закрепляйте сверло так, чтобы биение сверла не превышало 0,03 мм.

Примечание 7) Не зажимайте часть сверла со стружечными канавками.

М

ИНСТРУМЕНТ ДЛЯ
СВЕРЛЕНИЯ

СЕРИИ СВЕРЛ

М

ИНСТРУМЕНТ ДЛЯ
СВЕРЛЕНИЯ



M031

DIAEDGE

СОЗДАЕМ ЛУЧШЕЕ БУДУЩЕЕ ВМЕСТЕ С НАШИМИ КЛИЕНТАМИ

Представляем DIAEDGE — наш новый товарный знак, который воплощает самые передовые технологии, впечатляющие всех, кто использует их.

Наша цель — не только предлагать высококачественный инструмент, но и тесно взаимодействовать с нашими клиентами, вместе вдохновляться новыми идеями и решать более сложные задачи.



MITSUBISHI MATERIALS

M

ИНСТРУМЕНТ ДЛЯ
СВЕРЛЕНИЯ

DIA EDGE

М
ИНСТРУМЕНТ ДЛЯ
СВЕРЛЕНИЯ



 MITSUBISHI MATERIALS

ИНСТРУМЕНТ ДЛЯ СВЕРЛЕНИЯ



М

ИНСТРУМЕНТ ДЛЯ
СВЕРЛЕНИЯ

ИНСТРУМЕНТ ДЛЯ СВЕРЛЕНИЯ (МОНОЛИТНЫЕ ТВЕРДОСПЛАВНЫЕ СВЕРЛА)

ТВЕРДЫЙ СПЛАВ

MINI-MVS

- Прямая режущая кромка с улучшенным отводом стружки и повышенной прочностью. Двойная ленточка
- Обеспечивает сверлу малого диаметра оптимальную балансировку и точность.



Внутреннее охлаждение

М
ИНСТРУМЕНТ ДЛЯ СВЕРЛЕНИЯ

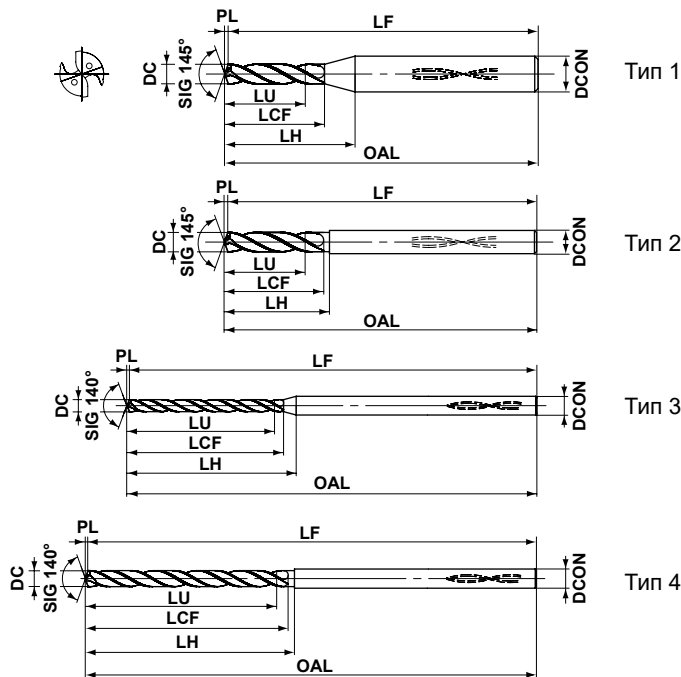

Обозначение	1 ≤ DC ≤ 2.9
MVS-X02- (пилотное сверло)	+0.014 0
Прочее	0 -0.014
Обозначение	DCON
MVS	0 -0.006

DC (мм)	Глубина сверления (L/D)	DP1020	Обозначение	Размеры (мм)							Тип
				LU	LCF	LH	OAL	LF	PL	DCON	
1.0	*2	●	MVS0100X02S030	2.2	5.2	8.9	55.2	55	0.2	3	1
	7	●	MVS0100X07S030	7.2	10.2	14.2	55.2	55	0.2	3	3
	12	●	MVS0100X12S030	12.2	15.2	19.2	55.2	55	0.2	3	3
	20	●	MVS0100X20S030	20.2	24.2	28.2	60.2	60	0.2	3	3
	25	●	MVS0100X25S030	25.2	28.2	32.2	66.2	66	0.2	3	3
	30	●	MVS0100X30S030	30.2	33.2	37.2	72.2	72	0.2	3	3
1.1	*2	●	MVS0110X02S030	2.4	5.6	9.1	55.2	55	0.2	3	1
	7	●	MVS0110X07S030	7.9	11.2	15.2	55.2	55	0.2	3	3
	12	●	MVS0110X12S030	13.4	17.2	21.2	55.2	55	0.2	3	3
	20	●	MVS0110X20S030	22.2	25.2	29.2	60.2	60	0.2	3	3
	25	●	MVS0110X25S030	27.7	31.2	34.2	66.2	66	0.2	3	3
	30	●	MVS0110X30S030	33.2	36.2	40.2	72.2	72	0.2	3	3
1.2	*2	●	MVS0120X02S030	2.6	6.2	9.6	55.2	55	0.2	3	1
	7	●	MVS0120X07S030	8.6	12.2	15.2	55.2	55	0.2	3	3
	12	●	MVS0120X12S030	14.6	18.2	21.2	55.2	55	0.2	3	3
	20	●	MVS0120X20S030	24.2	28.2	31.2	60.2	60	0.2	3	3
	25	●	MVS0120X25S030	30.2	34.2	37.2	66.2	66	0.2	3	3
	30	●	MVS0120X30S030	36.2	40.2	43.2	72.2	72	0.2	3	3
1.3	*2	●	MVS0130X02S030	2.8	6.6	9.8	55.2	55	0.2	3	1
	7	●	MVS0130X07S030	9.3	13.2	16.2	55.2	55	0.2	3	3
	12	●	MVS0130X12S030	15.8	20.2	23.2	55.2	55	0.2	3	3
	20	●	MVS0130X20S030	26.2	30.2	33.2	68.2	68	0.2	3	3
	25	●	MVS0130X25S030	32.7	36.2	40.2	74.2	74	0.2	3	3
	30	●	MVS0130X30S030	39.2	43.2	46.2	82.2	82	0.2	3	3

DC (мм)	Глубина сверления (L/D)	DP1020	Обозначение	Размеры (мм)							Тип
				LU	LCF	LH	OAL	LF	PL	DCON	
1.4	*2	●	MVS0140X02S030	3.0	7.2	10.2	55.2	55	0.2	3	1
	7	●	MVS0140X07S030	10.1	14.3	17.3	55.3	55	0.3	3	3
	12	●	MVS0140X12S030	17.1	21.3	24.3	55.3	55	0.3	3	3
	20	●	MVS0140X20S030	28.3	32.3	35.3	68.3	68	0.3	3	3
	25	●	MVS0140X25S030	35.3	39.3	42.3	74.3	74	0.3	3	3
	30	●	MVS0140X30S030	42.3	46.3	49.3	82.3	82	0.3	3	3
1.5	*2	●	MVS0150X02S030	3.2	7.6	10.4	55.2	55	0.2	3	1
	7	●	MVS0150X07S030	10.8	15.3	18.3	55.3	55	0.3	3	3
	12	●	MVS0150X12S030	18.3	23.3	26.3	55.3	55	0.3	3	3
	20	●	MVS0150X20S030	30.3	35.3	37.3	68.3	68	0.3	3	3
	25	●	MVS0150X25S030	37.8	42.3	45.3	74.3	74	0.3	3	3
	30	●	MVS0150X30S030	45.3	50.3	52.3	82.3	82	0.3	3	3
1.6	*2	●	MVS0160X02S030	3.5	8.3	10.9	68.3	68	0.3	3	1
	7	●	MVS0160X07S030	11.5	16.3	19.3	68.3	68	0.3	3	3
	12	●	MVS0160X12S030	19.5	24.3	27.3	68.3	68	0.3	3	3
	20	●	MVS0160X20S030	32.3	37.3	39.3	78.3	78	0.3	3	3
	25	●	MVS0160X25S030	40.3	45.3	47.3	86.3	86	0.3	3	3
	30	●	MVS0160X30S030	48.3	53.3	55.3	95.3	95	0.3	3	3
1.7	*2	●	MVS0170X02S030	3.7	8.7	11.1	68.3	68	0.3	3	1
	7	●	MVS0170X07S030	12.2	17.3	19.3	68.3	68	0.3	3	3
	12	●	MVS0170X12S030	20.7	26.3	28.3	68.3	68	0.3	3	3
	20	●	MVS0170X20S030	34.3	39.3	42.3	78.3	78	0.3	3	3
	25	●	MVS0170X25S030	42.8	48.3	50.3	86.3	86	0.3	3	3
	30	●	MVS0170X30S030	51.3	56.3	59.3	95.3	95	0.3	3	3

*2 = Пилотное сверло. Допуск +0.014 глубина отверстия DCx2

● : Есть на складе.

DC (мм)	Глубина сверления (L/D)	DP1020	Обозначение	Размеры (мм)							Тип
				LU	LCF	LH	OAL	LF	PL	DCON	
1.8	*2	●	MVS0180X02S030	3.9	9.3	11.5	68.3	68	0.3	3	1
	7	●	MVS0180X07S030	12.9	18.3	20.3	68.3	68	0.3	3	3
	12	●	MVS0180X12S030	21.9	27.3	29.3	68.3	68	0.3	3	3
	20	●	MVS0180X20S030	36.3	41.3	44.3	84.3	84	0.3	3	3
	25	●	MVS0180X25S030	45.3	50.3	53.3	94.3	94	0.3	3	3
	30	●	MVS0180X30S030	54.3	59.3	62.3	102.3	102	0.3	3	3
1.9	*2	●	MVS0190X02S030	4.1	9.7	11.8	68.3	68	0.3	3	1
	7	●	MVS0190X07S030	13.6	19.3	21.3	68.3	68	0.3	3	3
	12	●	MVS0190X12S030	23.1	29.3	31.3	68.3	68	0.3	3	3
	20	●	MVS0190X20S030	38.3	44.3	46.3	84.3	84	0.3	3	3
	25	●	MVS0190X25S030	47.8	53.3	55.3	94.3	94	0.3	3	3
	30	●	MVS0190X30S030	57.3	63.3	65.3	102.3	102	0.3	3	3
2.0	*2	●	MVS0200X02S030	4.3	10.3	12.2	68.3	68	0.3	3	1
	7	●	MVS0200X07S030	14.4	20.4	22.4	68.4	68	0.4	3	3
	12	●	MVS0200X12S030	24.4	30.4	32.4	68.4	68	0.4	3	3
	20	●	MVS0200X20S030	40.4	46.4	48.4	84.4	84	0.4	3	3
	25	●	MVS0200X25S030	50.4	56.4	58.4	94.4	94	0.4	3	3
	30	●	MVS0200X30S030	60.4	66.4	68.4	102.4	102	0.4	3	3
2.1	*2	●	MVS0210X02S030	4.5	10.7	12.4	74.3	74	0.3	3	1
	7	●	MVS0210X07S030	15.1	21.4	23.4	74.4	74	0.4	3	3
	12	●	MVS0210X12S030	25.6	32.4	34.4	74.4	74	0.4	3	3
	20	●	MVS0210X20S030	42.4	48.4	50.4	94.4	94	0.4	3	3
	25	●	MVS0210X25S030	52.9	59.4	60.4	107.4	107	0.4	3	3
	30	●	MVS0210X30S030	63.4	69.4	71.4	118.4	118	0.4	3	3
2.2	*2	●	MVS0220X02S030	4.7	11.3	12.8	74.3	74	0.3	3	1
	7	●	MVS0220X07S030	15.8	22.4	23.4	74.4	74	0.4	3	3
	12	●	MVS0220X12S030	26.8	33.4	34.4	74.4	74	0.4	3	3
	20	●	MVS0220X20S030	44.4	51.4	52.4	94.4	94	0.4	3	3
	25	●	MVS0220X25S030	55.4	62.4	63.4	107.4	107	0.4	3	3
	30	●	MVS0220X30S030	66.4	73.4	74.4	118.4	118	0.4	3	3
2.3	*2	●	MVS0230X02S030	5.0	11.8	13.1	74.4	74	0.4	3	1
	7	●	MVS0230X07S030	16.5	23.4	24.4	74.4	74	0.4	3	3
	12	●	MVS0230X12S030	28.0	35.4	36.4	74.4	74	0.4	3	3
	20	●	MVS0230X20S030	46.4	53.4	54.4	94.4	94	0.4	3	3
	25	●	MVS0230X25S030	57.9	64.4	66.4	107.4	107	0.4	3	3
	30	●	MVS0230X30S030	69.4	76.4	77.4	118.4	118	0.4	3	3
2.4	*2	●	MVS0240X02S030	5.2	12.4	13.5	74.4	74	0.4	3	1
	7	●	MVS0240X07S030	17.2	24.4	25.4	74.4	74	0.4	3	3
	12	●	MVS0240X12S030	29.2	36.4	37.4	74.4	74	0.4	3	3
	20	●	MVS0240X20S030	48.4	55.4	56.4	94.4	94	0.4	3	3
	25	●	MVS0240X25S030	60.4	67.4	68.4	107.4	107	0.4	3	3
	30	●	MVS0240X30S030	72.4	79.4	80.4	118.4	118	0.4	3	3
2.5	*2	●	MVS0250X02S030	5.4	12.8	13.7	74.4	74	0.4	3	1
	7	●	MVS0250X07S030	18.0	25.5	26.5	74.5	74	0.5	3	3
	12	●	MVS0250X12S030	30.5	38.5	39.5	74.5	74	0.5	3	3
	20	●	MVS0250X20S030	50.5	58.5	59.5	94.5	94	0.5	3	3
	25	●	MVS0250X25S030	63.0	70.5	71.5	107.5	107	0.5	3	3
	30	●	MVS0250X30S030	75.5	83.5	84.5	118.5	118	0.5	3	3

DC (мм)	Глубина сверления (L/D)	DP1020	Обозначение	Размеры (мм)							Тип
				LU	LCF	LH	OAL	LF	PL	DCON	
2.6	*2	●	MVS0260X02S030	5.6	13.4	13.4	81.4	81	0.4	3	2
	7	●	MVS0260X07S030	18.7	26.5	26.5	81.5	81	0.5	3	4
	12	●	MVS0260X12S030	31.7	39.5	39.5	81.5	81	0.5	3	4
	20	●	MVS0260X20S030	52.5	60.5	60.5	103.5	103	0.5	3	4
	25	●	MVS0260X25S030	65.5	73.5	73.5	117.5	117	0.5	3	4
	30	●	MVS0260X30S030	78.5	86.5	86.5	132.5	132	0.5	3	4
2.7	*2	●	MVS0270X02S030	5.8	13.8	13.8	81.4	81	0.4	3	2
	7	●	MVS0270X07S030	19.4	27.5	27.5	81.5	81	0.5	3	4
	12	●	MVS0270X12S030	32.9	41.5	41.5	81.5	81	0.5	3	4
	20	●	MVS0270X20S030	54.5	62.5	62.5	103.5	103	0.5	3	4
	25	●	MVS0270X25S030	68.0	76.5	76.5	117.5	117	0.5	3	4
	30	●	MVS0270X30S030	81.5	89.5	89.5	132.5	132	0.5	3	4
2.8	*2	●	MVS0280X02S030	6.0	14.4	14.4	81.4	81	0.4	3	2
	7	●	MVS0280X07S030	20.1	28.5	28.5	81.5	81	0.5	3	4
	12	●	MVS0280X12S030	34.1	42.5	42.5	81.5	81	0.5	3	4
	20	●	MVS0280X20S030	56.5	64.5	64.5	103.5	103	0.5	3	4
	25	●	MVS0280X25S030	70.5	78.5	78.5	117.5	117	0.5	3	4
	30	●	MVS0280X30S030	84.5	92.5	92.5	132.5	132	0.5	3	4
2.9	*2	●	MVS0290X02S030	6.3	14.9	14.9	81.5	81	0.5	3	2
	7	●	MVS0290X07S030	20.8	29.5	29.5	81.5	81	0.5	3	4
	12	●	MVS0290X12S030	35.3	44.5	44.5	81.5	81	0.5	3	4
	20	●	MVS0290X20S030	58.5	67.5	67.5	103.5	103	0.5	3	4
	25	●	MVS0290X25S030	73.0	81.5	81.5	117.5	117	0.5	3	4
	30	●	MVS0290X30S030	87.5	96.5	96.5	132.5	132	0.5	3	4

*2 = Пилотное сверло. Допуск +0.014 глубина отверстия DCx2

MINI-MVS

РЕКОМЕНДУЕМЫЕ РЕЖИМЫ РЕЗАНИЯ

Обрабатываемый материал		P					
		Малоуглеродистая сталь ($\leq 180\text{HB}$)		Углеродистая сталь Легированная сталь ($180-280\text{HB}$)		Углеродистая сталь Легированная сталь ($280-350\text{HB}$)	
Диам. сверла DC (мм)	L/D	Частота вращения (мин ⁻¹)	Подача (мин.—макс.) (мм/об)	Частота вращения (мин ⁻¹)	Подача (мин.—макс.) (мм/об)	Частота вращения (мин ⁻¹)	Подача (мин.—макс.) (мм/об)
1.0	2*,7DC	15900	0.04 (0.02—0.05)	15900	0.04 (0.02—0.05)	12700	0.04 (0.02—0.05)
	$\geq 12\text{DC}$	15900	0.02 (0.01—0.03)	12700	0.02 (0.01—0.03)	9500	0.02 (0.01—0.03)
1.5	2*,7DC	10600	0.05 (0.03—0.08)	10600	0.05 (0.03—0.08)	8400	0.05 (0.03—0.08)
	$\geq 12\text{DC}$	10600	0.05 (0.02—0.08)	8400	0.05 (0.03—0.08)	6300	0.05 (0.02—0.08)
2.0	2*,7DC	7900	0.07 (0.04—0.10)	7900	0.07 (0.04—0.10)	6300	0.07 (0.04—0.10)
	$\geq 12\text{DC}$	7900	0.07 (0.04—0.10)	7900	0.07 (0.04—0.10)	7900	0.07 (0.04—0.10)
2.5	2*,7DC	7600	0.09 (0.05—0.13)	7600	0.09 (0.05—0.13)	6300	0.09 (0.05—0.13)
	$\geq 12\text{DC}$	7600	0.09 (0.06—0.13)	6300	0.09 (0.06—0.13)	6300	0.08 (0.05—0.13)

Обрабатываемый материал		M		K			
		Аустенитная нержавеющая сталь ($\leq 200\text{HB}$)		Серый чугун ($\leq 350\text{МПа}$)		Ковкий чугун ($\leq 450\text{МПа}$)	
Диам. сверла DC (мм)	L/D	Частота вращения (мин ⁻¹)	Подача (мин.—макс.) (мм/об)	Частота вращения (мин ⁻¹)	Подача (мин.—макс.) (мм/об)	Частота вращения (мин ⁻¹)	Подача (мин.—макс.) (мм/об)
1.0	2*,7DC	9500	0.03 (0.02—0.05)	15900	0.04 (0.02—0.05)	12700	0.04 (0.02—0.05)
	$\geq 12\text{DC}$	9500	0.02 (0.01—0.03)	12700	0.02 (0.01—0.03)	9500	0.02 (0.01—0.03)
1.5	2*,7DC	6300	0.05 (0.03—0.07)	10600	0.05 (0.03—0.08)	8400	0.05 (0.03—0.08)
	$\geq 12\text{DC}$	6300	0.05 (0.02—0.08)	8400	0.05 (0.03—0.08)	6300	0.05 (0.02—0.08)
2.0	2*,7DC	4700	0.06 (0.04—0.08)	7900	0.07 (0.04—0.10)	6300	0.07 (0.04—0.10)
	$\geq 12\text{DC}$	4700	0.07 (0.04—0.10)	7900	0.07 (0.04—0.10)	7900	0.07 (0.04—0.10)
2.5	2*,7DC	5000	0.08 (0.05—0.10)	7600	0.09 (0.05—0.13)	6300	0.09 (0.05—0.13)
	$\geq 12\text{DC}$	3800	0.08 (0.05—0.12)	6300	0.09 (0.06—0.13)	6300	0.08 (0.05—0.12)

Обрабатываемый материал		N		S	
		Алюминиевые сплавы (Si<5%)		Жаропрочные сплавы	
Диам. сверла DC (мм)	L/D	Частота вращения (мин ⁻¹)	Подача (мин.—макс.) (мм/об)	Частота вращения (мин ⁻¹)	Подача (мин.—макс.) (мм/об)
1.0	2*,7DC	19000	0.05 (0.03—0.08)	3100	0.02 (0.01—0.03)
	$\geq 12\text{DC}$	15900	0.05 (0.03—0.08)	3100	0.02 (0.01—0.03)
1.5	2*,7DC	16900	0.07 (0.05—0.12)	2100	0.03 (0.02—0.04)
	$\geq 12\text{DC}$	14800	0.08 (0.05—0.12)	2100	0.03 (0.02—0.04)
2.0	2*,7DC	14300	0.10 (0.06—0.15)	2300	0.04 (0.03—0.05)
	$\geq 12\text{DC}$	12700	0.11 (0.06—0.15)	2300	0.04 (0.03—0.05)
2.5	2*,7DC	12700	0.13 (0.08—0.20)	1900	0.05 (0.04—0.06)
	$\geq 12\text{DC}$	11400	0.14 (0.08—0.20)	1900	0.05 (0.04—0.06)

*2 = Пилотное сверло. Глубина отверстия DCx2.

■ РУКОВОДСТВО ПО ИСПОЛЬЗОВАНИЮ MINI-MVS (L/D ≥ 10)

СВЕРЛЕНИЕ НА ПЛОСКИХ ПОВЕРХНОСТЯХ ● Сделать глухое отверстие

■ 1. Выполнить направляющее отверстие



- ① Используйте сверло с большим двойным углом в плане, чем у сверла длинного исполнения. Используйте сверло с минимальной длиной режущей кромки.
- ② Для обеспечения высокой точности отверстия, точно выполняйте направляющее отверстие.
- ③ Глубина сверления: около 1DC или глубже.
(Выберите глубину направляющего отверстия, соответствующую длине сверхдлинного сверла.)

■ 2. Предварительная обработка при помощи длинного сверла



- ① Вводите сверло в направляющее отверстие при низких оборотах (вращение 1000 мин^{-1} , скорость подачи $0,2-0,3 \text{ мм/об}$).
- ② Остановить сверло для глубоких отверстий $0,5-1 \text{ мм}$ до достижения дна направляющего отверстия.

■ 3. Сверление глубокого отверстия

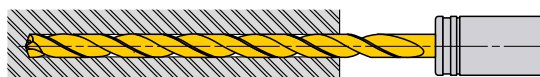

- ① Увеличьте частоту вращения и подачу за цикл и просверлите до желаемой глубины.

■ 4. Отвод сверла из отверстия



- ① После окончания сверления снизьте обороты, не доходя приблизительно $0,5-1 \text{ мм}$ до конца отверстия (частота вращения около 1000 мин^{-1}).
- ② Выньте сверло примерно до глубины направляющего отверстия ($V_f=3000 \text{ мм/мин}$.)
- ③ Выведите сверло из направляющего отверстия с уменьшенной частотой вращения ($n=300$, $V_f=3000 \text{ мм/мин}$)

СВЕРЛЕНИЕ НА НАКЛОННЫХ ПОВЕРХНОСТЯХ ● Отверстия на изогнутых заготовках

■ 1. Фрезерование плоских поверхностей



- ① Отфрезеруйте плоскую поверхность на заготовке фрезой, такого же диаметра, что и диаметр желаемого отверстия.

■ 2. Выполнить направляющее отверстие



- ① Используйте сверло с большим двойным углом в плане, чем у сверла длинного исполнения. Используйте сверло с минимальной длиной режущей кромки.
- ② Для обеспечения высокой точности отверстия, точно выполняйте направляющее отверстие.
- ③ Глубина сверления: около 1DC или глубже.
(Выберите глубину направляющего отверстия, соответствующую длине сверхдлинного сверла.)

■ 3. Предварительная обработка при помощи длинного сверла



- ① Вводите сверло в направляющее отверстие на низких оборотах (частота вращения 1000 мин^{-1} , скорость подачи $0,2-0,3 \text{ мм/об}$).
- ② Остановить длинное сверло за $0,5-1 \text{ мм}$ до достижения дна направляющего отверстия.

■ 4. Сверление глубокого отверстия

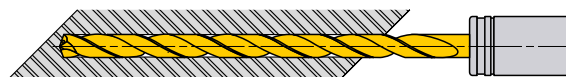

- ① Увеличьте частоту вращения и подачу за цикл и просверлите до желаемой глубины.

■ 5. Проходные отверстия

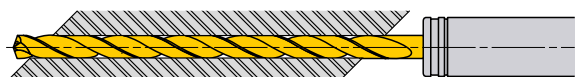

- ① При выходе из заготовки режущая кромка сверла может обломиться.
- ② При выводе сверла в отверстие снизьте скорость подачи.

■ 6. Отвод сверла из отверстия

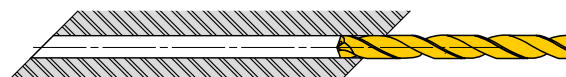

- ① Обработайте отверстие со скоростью резания $20-30 \text{ м/мин}$ и подачей $0,2-0,3 \text{ мм/об}$.
- ② Поднимите сверло из направляющего отверстия до глубины начальной точки с подачей 3000 мм/мин .

ИНСТРУМЕНТ ДЛЯ СВЕРЛЕНИЯ (МОНОЛИТНЫЕ ТВЕРДОСПЛАВНЫЕ СВЕРЛА)

ТВЕРДЫЙ СПЛАВ

MINI-MWS

- Микросверла с внутренним подводом СОЖ для стабильного сверления глубоких отверстий.
- Для высокоточного и эффективного сверления широкого спектра материалов от углеродистой стали до труднообрабатываемых материалов.



	$0.5 \leq DC < 1$
	$+0.009$ 0 -0.006
	0 -0.006

Внутреннее охлаждение

■ Тип SB

(Для сверления направляющих отверстий)

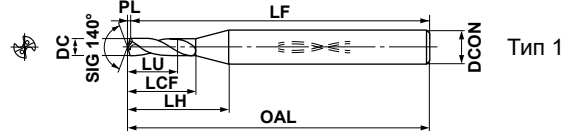

ИНСТРУМЕНТ ДЛЯ СВЕРЛЕНИЯ

M

	$0.5 \leq DC < 1$
	0 -0.009 0 -0.006
	0 -0.006

■ Тип LB/XB

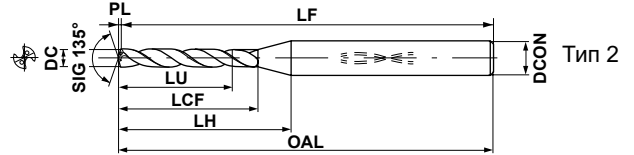

● Сверла MWS предназначены для использования с термодатчиками.

DC (мм)	Глубина сверления (L/D)	VP15TF	Обозначение	Размеры (мм)							Тип
				LU	LCF	LH	OAL	LF	PL	DCON	
0.50	1	●	MWS0050SB	0.6	2.6	7.3	47.1	47	0.09	3	1
	5	★	MWS0050LB	2.6	8.1	13.1	47.1	47	0.10	3	2
	12	★	MWS0050XB	6.1	16.1	21.1	47.1	47	0.10	3	2
0.51	1	★	MWS0051SB	0.6	2.7	7.3	47.1	47	0.09	3	1
	5	★	MWS0051LB	2.7	8.1	13.1	47.1	47	0.11	3	2
	12	★	MWS0051XB	6.2	16.1	21.1	47.1	47	0.11	3	2
0.52	1	★	MWS0052SB	0.6	2.7	7.3	47.1	47	0.09	3	1
	5	★	MWS0052LB	2.7	8.1	13.1	47.1	47	0.11	3	2
	12	★	MWS0052XB	6.4	16.1	21.1	47.1	47	0.11	3	2
0.53	1	★	MWS0053SB	0.6	2.7	7.3	47.1	47	0.10	3	1
	5	★	MWS0053LB	2.8	8.1	13.1	47.1	47	0.11	3	2
	12	★	MWS0053XB	6.5	16.1	21.1	47.1	47	0.11	3	2
0.54	1	★	MWS0054SB	0.6	2.7	7.3	47.1	47	0.10	3	1
	5	★	MWS0054LB	2.8	8.1	13.1	47.1	47	0.11	3	2
	12	★	MWS0054XB	6.6	16.1	21.1	47.1	47	0.11	3	2
0.55	1	●	MWS0055SB	0.7	2.7	7.3	47.1	47	0.10	3	1
	5	★	MWS0055LB	2.9	8.1	13.1	47.1	47	0.11	3	2
	12	★	MWS0055XB	6.7	16.1	21.1	47.1	47	0.11	3	2
0.56	1	★	MWS0056SB	0.7	3.0	7.6	47.1	47	0.10	3	1
	5	★	MWS0056LB	2.9	8.1	13.1	47.1	47	0.12	3	2
	12	★	MWS0056XB	6.8	16.1	21.1	47.1	47	0.12	3	2
0.57	1	★	MWS0057SB	0.7	3.0	7.5	47.1	47	0.10	3	1
	5	★	MWS0057LB	3.0	8.1	13.1	47.1	47	0.12	3	2
	12	★	MWS0057XB	7.0	16.1	21.1	47.1	47	0.12	3	2

DC (мм)	Глубина сверления (L/D)	VP15TF	Обозначение	Размеры (мм)							Тип
				LU	LCF	LH	OAL	LF	PL	DCON	
0.58	1	★	MWS0058SB	0.7	3.0	7.5	47.1	47	0.11	3	1
	5	★	MWS0058LB	3.0	8.1	13.1	47.1	47	0.12	3	2
	12	★	MWS0058XB	7.1	16.1	21.1	47.1	47	0.12	3	2
0.59	1	★	MWS0059SB	0.7	3.0	7.5	47.1	47	0.11	3	1
	5	★	MWS0059LB	3.1	8.1	12.1	47.1	47	0.12	3	2
	12	★	MWS0059XB	7.2	16.1	20.1	47.1	47	0.12	3	2
0.60	1	●	MWS0060SB	0.7	3.0	7.5	47.1	47	0.11	3	1
	5	★	MWS0060LB	3.1	8.1	12.1	47.1	47	0.12	3	2
	12	★	MWS0060XB	7.3	16.1	20.1	47.1	47	0.12	3	2
0.61	1	★	MWS0061SB	0.7	3.2	7.7	47.1	47	0.11	3	1
	5	★	MWS0061LB	3.2	8.1	12.1	47.1	47	0.13	3	2
	12	★	MWS0061XB	7.5	16.1	20.1	47.1	47	0.13	3	2
0.62	1	★	MWS0062SB	0.7	3.2	7.6	47.1	47	0.11	3	1
	5	★	MWS0062LB	3.2	8.1	12.1	47.1	47	0.13	3	2
	12	★	MWS0062XB	7.6	16.1	20.1	47.1	47	0.13	3	2
0.63	1	★	MWS0063SB	0.7	3.2	7.6	47.1	47	0.11	3	1
	5	★	MWS0063LB	3.3	8.1	12.1	47.1	47	0.13	3	2
	12	★	MWS0063XB	7.7	16.1	20.1	47.1	47	0.13	3	2
0.64	1	★	MWS0064SB	0.8	3.2	7.6	47.1	47	0.12	3	1
	5	★	MWS0064LB	3.3	8.1	12.1	47.1	47	0.13	3	2
	12	★	MWS0064XB	7.8	16.1	20.1	47.1	47	0.13	3	2
0.65	1	●	MWS0065SB	0.8	3.2	7.6	47.1	47	0.12	3	1
	5	★	MWS0065LB	3.4	8.1	12.1	47.1	47	0.13	3	2
	12	★	MWS0065XB	7.9	16.1	20.1	47.1	47	0.13	3	2

Примечание 1) Пожалуйста, свяжитесь с нами если Вы не нашли нужную геометрию в данном каталоге (могут быть заказаны другие диаметры и длины).

● : Есть на складе. ★ : Со склада в Японии.

DC (мм)	Глубина сверления (L/D)	VP15TF	Обозначение	Размеры (мм)							Тип
				LU	LCF	LH	OAL	LF	PL	DCON	
0.66	1	★	MWS0066SB	0.8	3.5	7.9	47.1	47	0.12	3	1
	5	★	MWS0066LB	3.4	8.1	12.1	47.1	47	0.14	3	2
	12	★	MWS0066XB	8.1	16.1	20.1	47.1	47	0.14	3	2
0.67	1	★	MWS0067SB	0.8	3.5	7.8	47.1	47	0.12	3	1
	5	★	MWS0067LB	3.5	8.1	12.1	47.1	47	0.14	3	2
	12	★	MWS0067XB	8.2	16.1	20.1	47.1	47	0.14	3	2
0.68	1	★	MWS0068SB	0.8	3.5	7.8	47.1	47	0.12	3	1
	5	★	MWS0068LB	3.5	8.1	12.1	47.1	47	0.14	3	2
	12	★	MWS0068XB	8.3	16.1	20.1	47.1	47	0.14	3	2
0.69	1	★	MWS0069SB	0.8	3.5	7.8	47.1	47	0.13	3	1
	5	★	MWS0069LB	3.6	8.1	12.1	47.1	47	0.14	3	2
	12	★	MWS0069XB	8.4	16.1	20.1	47.1	47	0.14	3	2
0.70	1	●	MWS0070SB	0.8	3.5	7.8	47.1	47	0.13	3	1
	5	★	MWS0070LB	3.6	8.1	12.1	47.1	47	0.14	3	2
	12	★	MWS0070XB	8.5	16.1	20.1	47.1	47	0.14	3	2
0.71	1	★	MWS0071SB	0.8	3.7	8.0	50.1	50	0.13	3	1
	5	★	MWS0071LB	3.7	10.1	14.1	50.1	50	0.15	3	2
	12	★	MWS0071XB	8.7	20.1	24.1	50.1	50	0.15	3	2
0.72	1	★	MWS0072SB	0.9	3.7	8.0	50.1	50	0.13	3	1
	5	★	MWS0072LB	3.8	10.1	14.1	50.1	50	0.15	3	2
	12	★	MWS0072XB	8.8	20.1	24.1	50.1	50	0.15	3	2
0.73	1	★	MWS0073SB	0.9	3.7	7.9	50.1	50	0.13	3	1
	5	★	MWS0073LB	3.8	10.1	14.1	50.1	50	0.15	3	2
	12	★	MWS0073XB	8.9	20.1	24.1	50.1	50	0.15	3	2
0.74	1	★	MWS0074SB	0.9	3.7	7.9	50.1	50	0.13	3	1
	5	★	MWS0074LB	3.9	10.1	14.1	50.1	50	0.15	3	2
	12	★	MWS0074XB	9.0	20.1	24.1	50.1	50	0.15	3	2
0.75	1	●	MWS0075SB	0.9	3.7	7.9	50.1	50	0.14	3	1
	5	★	MWS0075LB	3.9	10.1	14.1	50.1	50	0.16	3	2
	12	★	MWS0075XB	9.2	20.1	24.1	50.1	50	0.16	3	2
0.76	1	★	MWS0076SB	0.9	4.0	8.2	50.1	50	0.14	3	1
	5	★	MWS0076LB	4.0	10.1	14.1	50.1	50	0.16	3	2
	12	★	MWS0076XB	9.3	20.1	24.1	50.1	50	0.16	3	2
0.77	1	★	MWS0077SB	0.9	4.0	8.2	50.1	50	0.14	3	1
	5	★	MWS0077LB	4.0	10.1	14.1	50.1	50	0.16	3	2
	12	★	MWS0077XB	9.4	20.1	24.1	50.1	50	0.16	3	2
0.78	1	★	MWS0078SB	0.9	4.0	8.1	50.1	50	0.14	3	1
	5	★	MWS0078LB	4.1	10.1	14.1	50.1	50	0.16	3	2
	12	★	MWS0078XB	9.5	20.1	24.1	50.1	50	0.16	3	2
0.79	1	★	MWS0079SB	0.9	4.0	8.1	50.1	50	0.14	3	1
	5	★	MWS0079LB	4.1	10.1	14.1	50.1	50	0.16	3	2
	12	★	MWS0079XB	9.6	20.1	24.1	50.1	50	0.16	3	2
0.80	1	●	MWS0080SB	1.0	4.1	8.2	50.2	50	0.15	3	1
	5	★	MWS0080LB	4.2	10.2	14.2	50.2	50	0.17	3	2
	12	★	MWS0080XB	9.8	20.2	24.2	50.2	50	0.17	3	2
0.81	1	★	MWS0081SB	1.0	4.3	8.4	50.2	50	0.15	3	1
	5	★	MWS0081LB	4.2	10.2	14.2	50.2	50	0.17	3	2
	12	★	MWS0081XB	9.9	20.2	24.2	50.2	50	0.17	3	2
0.82	1	★	MWS0082SB	1.0	4.3	8.4	50.2	50	0.15	3	1
	5	★	MWS0082LB	4.3	10.2	14.2	50.2	50	0.17	3	2
	12	★	MWS0082XB	10.0	20.2	24.2	50.2	50	0.17	3	2

DC (мм)	Глубина сверления (L/D)	VP15TF	Обозначение	Размеры (мм)							Тип
				LU	LCF	LH	OAL	LF	PL	DCON	
0.83	1	★	MWS0083SB	1.0	4.3	8.3	50.2	50	0.15	3	1
	5	★	MWS0083LB	4.3	10.2	14.2	50.2	50	0.17	3	2
	12	★	MWS0083XB	10.1	20.2	24.2	50.2	50	0.17	3	2
0.84	1	★	MWS0084SB	1.0	4.3	8.3	50.2	50	0.15	3	1
	5	★	MWS0084LB	4.4	10.2	14.2	50.2	50	0.17	3	2
	12	★	MWS0084XB	10.3	20.2	24.2	50.2	50	0.17	3	2
0.85	1	●	MWS0085SB	1.0	4.3	8.3	50.2	50	0.15	3	1
	5	★	MWS0085LB	4.4	10.2	14.2	50.2	50	0.18	3	2
	12	★	MWS0085XB	10.4	20.2	24.2	50.2	50	0.18	3	2
0.86	1	★	MWS0086SB	1.0	4.6	8.6	50.2	50	0.16	3	1
	5	★	MWS0086LB	4.5	10.2	14.2	50.2	50	0.18	3	2
	12	★	MWS0086XB	10.5	20.2	24.2	50.2	50	0.18	3	2
0.87	1	★	MWS0087SB	1.0	4.6	8.6	50.2	50	0.16	3	1
	5	★	MWS0087LB	4.5	10.2	14.2	50.2	50	0.18	3	2
	12	★	MWS0087XB	10.6	20.2	24.2	50.2	50	0.18	3	2
0.88	1	★	MWS0088SB	1.0	4.6	8.6	50.2	50	0.16	3	1
	5	★	MWS0088LB	4.6	10.2	14.2	50.2	50	0.18	3	2
	12	★	MWS0088XB	10.7	20.2	24.2	50.2	50	0.18	3	2
0.89	1	★	MWS0089SB	1.1	4.6	8.5	50.2	50	0.16	3	1
	5	★	MWS0089LB	4.6	10.2	14.2	50.2	50	0.18	3	2
	12	★	MWS0089XB	10.9	20.2	24.2	50.2	50	0.18	3	2
0.90	1	●	MWS0090SB	1.1	4.6	8.5	50.2	50	0.16	3	1
	5	★	MWS0090LB	4.7	10.2	14.2	50.2	50	0.19	3	2
	12	★	MWS0090XB	11.0	20.2	24.2	50.2	50	0.19	3	2
0.91	1	★	MWS0091SB	1.1	4.8	8.7	50.2	50	0.17	3	1
	5	★	MWS0091LB	4.7	10.2	14.2	50.2	50	0.19	3	2
	12	★	MWS0091XB	11.1	20.2	24.2	50.2	50	0.19	3	2
0.92	1	★	MWS0092SB	1.1	4.8	8.7	50.2	50	0.17	3	1
	5	★	MWS0092LB	4.8	10.2	14.2	50.2	50	0.19	3	2
	12	★	MWS0092XB	11.2	20.2	24.2	50.2	50	0.19	3	2
0.93	1	★	MWS0093SB	1.1	4.8	8.7	50.2	50	0.17	3	1
	5	★	MWS0093LB	4.8	10.2	14.2	50.2	50	0.19	3	2
	12	★	MWS0093XB	11.4	20.2	24.2	50.2	50	0.19	3	2
0.94	1	★	MWS0094SB	1.1	4.8	8.6	50.2	50	0.17	3	1
	5	★	MWS0094LB	4.9	10.2	14.2	50.2	50	0.19	3	2
	12	★	MWS0094XB	11.5	20.2	24.2	50.2	50	0.19	3	2
0.95	1	●	MWS0095SB	1.1	4.8	8.6	50.2	50	0.17	3	1
	5	★	MWS0095LB	5.0	10.2	14.2	50.2	50	0.20	3	2
	12	★	MWS0095XB	11.6	20.2	24.2	50.2	50	0.20	3	2
0.96	1	★	MWS0096SB	1.1	5.1	8.9	50.2	50	0.17	3	1
	5	★	MWS0096LB	5.0	10.2	14.2	50.2	50	0.20	3	2
	12	★	MWS0096XB	11.7	20.2	24.2	50.2	50	0.20	3	2
0.97	1	★	MWS0097SB	1.2	5.1	8.9	50.2	50	0.18	3	1
	5	★	MWS0097LB	5.1	10.2	14.2	50.2	50	0.20	3	2
	12	★	MWS0097XB	11.8	20.2	24.2	50.2	50	0.20	3	2
0.98	1	★	MWS0098SB	1.2	5.1	8.9	50.2	50	0.18	3	1
	5	★	MWS0098LB	5.1	10.2	14.2	50.2	50	0.20	3	2
	12	★	MWS0098XB	12.0	20.2	24.2	50.2	50	0.20	3	2
0.99	1	★	MWS0099SB	1.2	5.1	8.9	50.2	50	0.18	3	1
	5	★	MWS0099LB	5.2	10.2	14.2	50.2	50	0.21	3	2
	12	★	MWS0099XB	12.1	20.2	24.2	50.2	50	0.21	3	2

Примечание 1) Пожалуйста, свяжитесь с нами если Вы не нашли нужную геометрию в данном каталоге (могут быть заказаны другие диаметры и длины).

MINI-MWS

РЕКОМЕНДУЕМЫЕ РЕЖИМЫ РЕЗАНИЯ

■ Тип SB/LB/XB (L/D<10)

Обработываемый материал	P							
	Малоуглеродистая сталь ($\leq 180\text{HB}$)				Углеродистая сталь, Легированная сталь (180–280HB)			
	Ck10				Ck45, 42CrMo4			
Диам. сверла DC (мм)	Скорость резания (м/мин)	Частота вращения (мин^{-1})	Подача (мин. — макс.) (мм/об)	Подача (мм/мин)	Скорость резания (м/мин)	Частота вращения (мин^{-1})	Подача (мин. — макс.) (мм/об)	Подача (мм/мин)
0.5	40	25400	0.010 (0.005–0.015)	250	40	25400	0.010 (0.005–0.015)	250
0.63	40	20200	0.014 (0.008–0.020)	280	40	20200	0.014 (0.008–0.020)	280
0.8	45	17900	0.028 (0.016–0.040)	500	45	17900	0.028 (0.016–0.040)	500
1.0	50	15900	0.035 (0.020–0.050)	555	50	15900	0.035 (0.020–0.050)	555

Обработываемый материал	P				M			
	Углеродистая сталь, Легированная сталь (280–350HB)				Аустенитная нержавеющая сталь ($\leq 200\text{HB}$)			
	36CrNiMo4				X5CrNi1810, X5CrNiMo17-12-2			
Диам. сверла DC (мм)	Скорость резания (м/мин)	Частота вращения (мин^{-1})	Подача (мин. — макс.) (мм/об)	Подача (мм/мин)	Скорость резания (м/мин)	Частота вращения (мин^{-1})	Подача (мин. — макс.) (мм/об)	Подача (мм/мин)
0.5	30	19000	0.010 (0.005–0.015)	190	20	12700	0.008 (0.005–0.010)	100
0.63	30	15100	0.014 (0.008–0.020)	210	20	10100	0.010 (0.008–0.013)	100
0.8	35	13900	0.028 (0.016–0.040)	385	25	9900	0.020 (0.016–0.026)	195
1.0	40	12700	0.035 (0.020–0.050)	440	30	9500	0.030 (0.020–0.044)	285

Обработываемый материал	K							
	Серый чугун ($\leq 350\text{MPa}$)				Ковкий чугун ($\leq 450\text{MPa}$)			
	GG30				GGG45			
Диам. сверла DC (мм)	Скорость резания (м/мин)	Частота вращения (мин^{-1})	Подача (мин. — макс.) (мм/об)	Подача (мм/мин)	Скорость резания (м/мин)	Частота вращения (мин^{-1})	Подача (мин. — макс.) (мм/об)	Подача (мм/мин)
0.5	40	25400	0.010 (0.005–0.015)	250	30	19000	0.010 (0.005–0.015)	190
0.63	40	20200	0.014 (0.008–0.020)	280	30	15100	0.014 (0.008–0.020)	210
0.8	45	17900	0.028 (0.016–0.040)	500	35	13900	0.028 (0.016–0.040)	385
1.0	50	15900	0.035 (0.020–0.050)	555	40	12700	0.035 (0.020–0.050)	440

Обработываемый материал	N				S			
	Алюминиевые сплавы ($\text{Si}<5\%$)				Жаропрочные сплавы			
					Inconel718			
Диам. сверла DC (мм)	Скорость резания (м/мин)	Частота вращения (мин^{-1})	Подача (мин. — макс.) (мм/об)	Подача (мм/мин)	Скорость резания (м/мин)	Частота вращения (мин^{-1})	Подача (мин. — макс.) (мм/об)	Подача (мм/мин)
0.5	40	25400	0.014 (0.008–0.020)	355	10	6300	0.006 (0.004–0.008)	35
0.63	40	20200	0.020 (0.012–0.030)	400	10	5000	0.008 (0.007–0.010)	40
0.8	45	17900	0.036 (0.024–0.050)	640	10	3900	0.016 (0.013–0.021)	60
1.0	60	19000	0.050 (0.030–0.075)	950	10	3100	0.020 (0.016–0.027)	60

ИНСТРУКЦИЯ ПО ЭКСПЛУАТАЦИИ

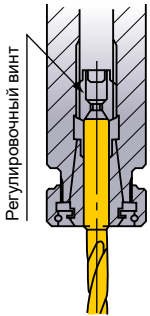
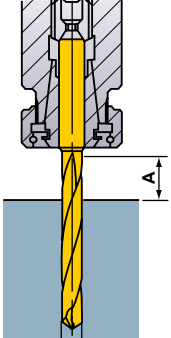
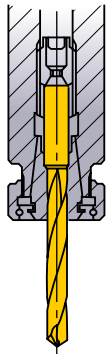
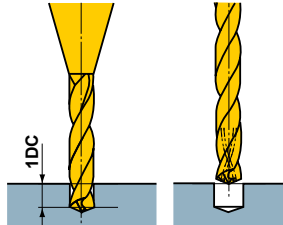
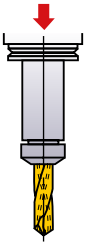
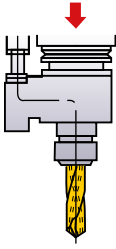
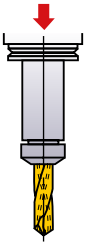
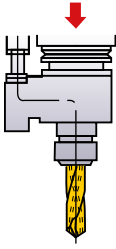
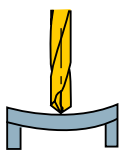
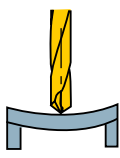
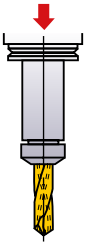
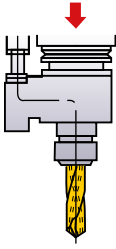
<p>Крепление сверла</p>  <p>Регулируемый винт</p> <p>Цанговый патрон с упорным подшипником надежно держит сверло.</p>	<p>Длина сверла</p>  <p>$A \geq DC \times 2.0$</p>	<p>Установка сверла</p>  <p>Не прижимать по режущей кромке.</p>	<p>Установка сверла</p>  <p>1DC</p> <ol style="list-style-type: none"> Для пилотного отверстия используйте сверла короткой серии (SB). Применяя сверло с отверстием для подачи СОЖ, используйте предварительно обработанное отверстие как направляющее. В зависимости от режимов обработки рекомендуется подача с периодическим выводом сверла из отверстия. 				
<p>Тип охлаждения через сквозные отверстия</p> <table border="0"> <tr> <td>Тип охлаждения через шпиндель</td> <td>Тип охлаждения на вращающийся шпиндель станка</td> </tr> <tr> <td></td> <td></td> </tr> </table> <p>Рекомендуемое давление охлаждающей среды не менее 15 Бар и не более 30 Бар</p>	Тип охлаждения через шпиндель	Тип охлаждения на вращающийся шпиндель станка			<p>Тонкая заготовка</p>  <p>Необходима опора для заготовки.</p> <p>OK</p>  <p>Если наблюдается отгиб.</p> <p>X</p>	<p>Рекомендации по использованию СОЖ</p> <ol style="list-style-type: none"> Мелкая металлическая стружка забивается в отверстие для подачи СОЖ в сверлах малого диаметра. Для предотвращения этого процесса обязательно используйте мелкий сетчатый фильтр. Частицы грязи и пыли прилипают к маслу в составе СОЖ и препятствуют эффективной подаче СОЖ. Рекомендуется регулярно менять СОЖ. 	
Тип охлаждения через шпиндель	Тип охлаждения на вращающийся шпиндель станка						
							

ПРИМЕЧАНИЯ К ЭКСПЛУАТАЦИИ

- Используйте мелкий сетчатый фильтр (меш $\leq 5\mu\text{m}$) для СОЖ, для того чтобы предотвратить образование пробки в отверстии

ИНСТРУМЕНТ ДЛЯ СВЕРЛЕНИЯ (МОНОЛИТНЫЕ ТВЕРДОСПЛАВНЫЕ СВЕРЛА)

MPS1

- Новое многофункциональное покрытие PVD на основе AlTiCrN.
- Тип MPS1 с двойной ленточкой для точного и надежного сверления.



L/D=2 PC L/D=3-5 L/D=8 L/D=10-40

Сверхдлинные сверла с четырьмя ленточками



Внутреннее охлаждение



● **Тип 1** Цилиндрический тип хвостовика с конической шейкой

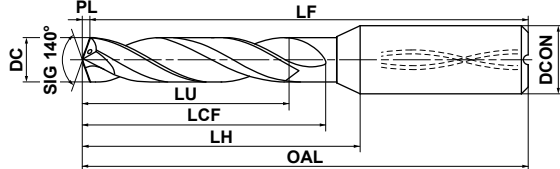

MPS1----S/L-DIN-C/L8C-L40C

● **Тип 3** Тип хвостовика Whistle notch с конической шейкой

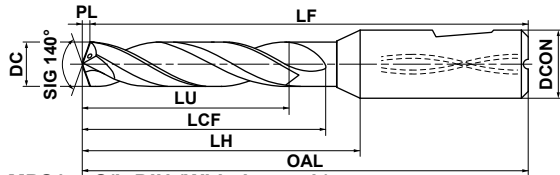

MPS1----S/L-DIN (Whistle notch)



	3≤DC≤6	6<DC≤10	10<DC≤18	18<DC≤20
DIN / PC	+0.010 -0.002	+0.010 -0.005	+0.005 -0.013	+0.005 -0.016
L___C	0 -0.012	0 -0.015	0 -0.018	0 -0.021
h6	0 -0.008	0 -0.009	0 -0.011	0 -0.013

*Отверстие для подачи СОЖ диаметром не более ø4,9 мм будет иметь круглую форму.
*SIG : L/D 3-5 и 10-40 = 140°, 8 = 135°, PC = 145°

● **Тип 2** Цилиндрический тип хвостовика

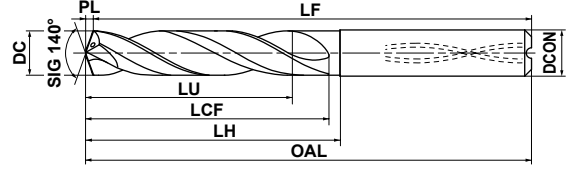

MPS1----S/L-DIN-C/L8C-L40C

● **Тип 4** Тип хвостовика Whistle notch

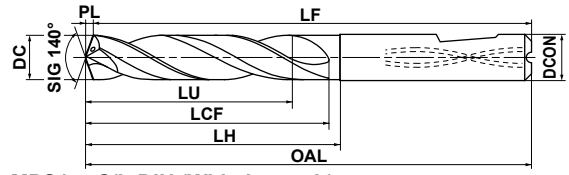

MPS1----S/L-DIN (Whistle notch)

DC (мм)	Глубина сверления (L/D)	DP1021	Обозначение	Размеры (мм)						Тип	
				LU	LCF	LH	OAL	LF	PL		DCON
3.0	3	□	MPS1-0300S-DIN	15.0	19.5	24.5	61.5	61	0.5	6	3
	3	●	MPS1-0300S-DIN-C	15.0	19.5	24.5	61.5	61	0.5	6	1
	5	□	MPS1-0300L-DIN	20.0	24.5	28.5	65.5	65	0.5	6	3
	5	●	MPS1-0300L-DIN-C	20.0	24.5	28.5	65.5	65	0.5	6	1
	2	●	MPS1-0300-PC	6.5	16.5	19.7	55.5	55	0.5	6	1
	8	●	MPS1-0300-L8C	24.6	33.6	39.6	76.6	76	0.6	6	1
	10	●	MPS1-0300-L10C	30.5	37.5	42.5	79.5	79	0.5	6	1
	12	●	MPS1-0300-L12C	36.5	43.5	48.5	85.5	85	0.5	6	1
	15	●	MPS1-0300-L15C	45.5	52.5	57.5	94.5	94	0.5	6	1
	20	●	MPS1-0300-L20C	60.5	67.5	72.5	109.5	109	0.5	6	1
25	●	MPS1-0300-L25C	75.5	82.5	87.5	124.5	124	0.5	6	1	
30	●	MPS1-0300-L30C	90.5	97.5	102.5	139.5	139	0.5	6	1	
35	□	MPS1-0300-L35C	105.5	113.5	121.5	158.5	158	0.5	6	1	
40	●	MPS1-0300-L40C	120.5	128.5	136.5	173.5	173	0.5	6	1	
3.05	3	□	MPS1-0305S-DIN	15.0	19.6	24.6	61.6	61	0.6	6	3
	3	●	MPS1-0305S-DIN-C	15.0	19.6	24.6	61.6	61	0.6	6	1
	5	□	MPS1-0305L-DIN	20.0	24.6	28.6	65.6	65	0.6	6	3
	5	●	MPS1-0305L-DIN-C	20.0	24.6	28.6	65.6	65	0.6	6	1
3.1	3	□	MPS1-0310S-DIN	14.9	19.6	24.6	61.6	61	0.6	6	3
	3	●	MPS1-0310S-DIN-C	14.9	19.6	24.6	61.6	61	0.6	6	1
	5	□	MPS1-0310L-DIN	19.9	24.6	28.6	65.6	65	0.6	6	3
	5	●	MPS1-0310L-DIN-C	19.9	24.6	28.6	65.6	65	0.6	6	1
	2	●	MPS1-0310-PC	6.7	18.5	21.6	55.5	55	0.5	6	1
	8	●	MPS1-0310-L8C	25.4	39.6	45.6	82.6	82	0.6	6	1
	10	□	MPS1-0310-L10C	31.6	44.6	49.6	86.6	86	0.6	6	1
	12	●	MPS1-0310-L12C	37.8	51.6	56.6	93.6	93	0.6	6	1
	15	●	MPS1-0310-L15C	47.1	61.6	66.6	103.6	103	0.6	6	1
	20	●	MPS1-0310-L20C	62.6	79.6	84.6	121.6	121	0.6	6	1
25	●	MPS1-0310-L25C	78.1	96.6	101.6	138.6	138	0.6	6	1	
30	●	MPS1-0310-L30C	93.6	114.6	119.6	156.6	156	0.6	6	1	
35	□	MPS1-0310-L35C	109.1	123.6	138.6	175.6	175	0.6	6	1	
40	●	MPS1-0310-L40C	124.6	138.6	153.6	190.6	190	0.6	6	1	

DC (мм)	Глубина сверления (L/D)	DP1021	Обозначение	Размеры (мм)						Тип	
				LU	LCF	LH	OAL	LF	PL		DCON
3.2	3	□	MPS1-0320S-DIN	14.8	19.6	24.6	61.6	61	0.6	6	3
	3	●	MPS1-0320S-DIN-C	14.8	19.6	24.6	61.6	61	0.6	6	1
	5	□	MPS1-0320L-DIN	19.8	24.6	28.6	65.6	65	0.6	6	3
	5	●	MPS1-0320L-DIN-C	19.8	24.6	28.6	65.6	65	0.6	6	1
	2	●	MPS1-0320-PC	6.9	18.5	21.5	55.5	55	0.5	6	1
	8	●	MPS1-0320-L8C	26.3	39.7	45.7	82.7	82	0.7	6	1
	10	□	MPS1-0320-L10C	32.6	44.6	49.6	86.6	86	0.6	6	1
	12	●	MPS1-0320-L12C	39.0	51.6	56.6	93.6	93	0.6	6	1
	15	●	MPS1-0320-L15C	48.6	61.6	66.6	103.6	103	0.6	6	1
	20	●	MPS1-0320-L20C	64.6	79.6	84.6	121.6	121	0.6	6	1
25	●	MPS1-0320-L25C	80.6	96.6	101.6	138.6	138	0.6	6	1	
30	●	MPS1-0320-L30C	96.6	114.6	119.6	156.6	156	0.6	6	1	
35	□	MPS1-0320-L35C	112.6	123.6	138.6	175.6	175	0.6	6	1	
40	●	MPS1-0320-L40C	128.6	138.6	153.6	190.6	190	0.6	6	1	
3.3	3	□	MPS1-0330S-DIN	14.7	19.6	24.6	61.6	61	0.6	6	3
	3	●	MPS1-0330S-DIN-C	14.7	19.6	24.6	61.6	61	0.6	6	1
	5	□	MPS1-0330L-DIN	20.2	25.1	28.6	65.6	65	0.6	6	3
	5	●	MPS1-0330L-DIN-C	20.2	25.1	28.6	65.6	65	0.6	6	1
	2	●	MPS1-0330-PC	7.1	18.5	21.4	55.5	55	0.5	6	1
	8	●	MPS1-0330-L8C	27.1	39.7	45.7	82.7	82	0.7	6	1
	10	□	MPS1-0330-L10C	33.6	44.6	49.6	86.6	86	0.6	6	1
	12	●	MPS1-0330-L12C	40.2	51.6	56.6	93.6	93	0.6	6	1
	15	●	MPS1-0330-L15C	50.1	61.6	66.6	103.6	103	0.6	6	1
	20	●	MPS1-0330-L20C	66.6	79.6	84.6	121.6	121	0.6	6	1
25	●	MPS1-0330-L25C	83.1	96.6	101.6	138.6	138	0.6	6	1	
30	●	MPS1-0330-L30C	99.6	114.6	119.6	156.6	156	0.6	6	1	
35	□	MPS1-0330-L35C	116.1	132.6	138.6	175.6	175	0.6	6	1	
40	●	MPS1-0330-L40C	132.6	148.6	153.6	190.6	190	0.6	6	1	

● : Есть на складе. □ : Нет на складе, выпускается исключительно под заказ.

DC (мм)	Глубина сверления (L/D)	DP1021	Обозначение	Размеры (мм)							Тип
				LU	LCF	LH	OAL	LF	PL	DCON	
3.4	3	□	MPS1-0340S-DIN	14.5	19.6	24.6	61.6	61	0.6	6	3
	3	●	MPS1-0340S-DIN-C	14.5	19.6	24.6	61.6	61	0.6	6	1
	5	□	MPS1-0340L-DIN	20.0	25.1	28.6	65.6	65	0.6	6	3
	5	●	MPS1-0340L-DIN-C	20.0	25.1	28.6	65.6	65	0.6	6	1
	2	●	MPS1-0340-PC	7.3	18.5	21.3	55.5	55	0.5	6	1
	8	●	MPS1-0340-L8C	27.9	39.7	45.7	82.7	82	0.7	6	1
	10	□	MPS1-0340-L10C	34.6	44.6	49.6	86.6	86	0.6	6	1
	12	●	MPS1-0340-L12C	41.4	51.6	56.6	93.6	93	0.6	6	1
	15	●	MPS1-0340-L15C	51.6	61.6	66.6	103.6	103	0.6	6	1
	20	●	MPS1-0340-L20C	68.6	79.6	84.6	121.6	121	0.6	6	1
	25	●	MPS1-0340-L25C	85.6	96.6	101.6	138.6	138	0.6	6	1
	30	●	MPS1-0340-L30C	102.6	114.6	119.6	156.6	156	0.6	6	1
35	□	MPS1-0340-L35C	119.6	132.6	138.6	175.6	175	0.6	6	1	
40	●	MPS1-0340-L40C	136.6	148.6	153.6	190.6	190	0.6	6	1	
3.5	3	□	MPS1-0350S-DIN	14.4	19.6	24.6	61.6	61	0.6	6	3
	3	●	MPS1-0350S-DIN-C	14.4	19.6	24.6	61.6	61	0.6	6	1
	5	□	MPS1-0350L-DIN	19.9	25.1	28.6	65.6	65	0.6	6	3
	5	●	MPS1-0350L-DIN-C	19.9	25.1	28.6	65.6	65	0.6	6	1
	2	●	MPS1-0350-PC	7.6	18.6	21.2	55.6	55	0.6	6	1
	8	●	MPS1-0350-L8C	28.7	39.7	45.7	82.7	82	0.7	6	1
	10	□	MPS1-0350-L10C	35.6	44.6	49.6	86.6	86	0.6	6	1
	12	●	MPS1-0350-L12C	42.6	51.6	56.6	93.6	93	0.6	6	1
	15	●	MPS1-0350-L15C	53.1	61.6	66.6	103.6	103	0.6	6	1
	20	●	MPS1-0350-L20C	70.6	79.6	84.6	121.6	121	0.6	6	1
	25	●	MPS1-0350-L25C	88.1	96.6	101.6	138.6	138	0.6	6	1
	30	●	MPS1-0350-L30C	105.6	114.6	119.6	156.6	156	0.6	6	1
35	□	MPS1-0350-L35C	123.1	132.6	138.6	175.6	175	0.6	6	1	
40	●	MPS1-0350-L40C	140.6	148.6	153.6	190.6	190	0.6	6	1	
3.6	3	□	MPS1-0360S-DIN	14.3	19.7	24.7	61.7	61	0.7	6	3
	3	●	MPS1-0360S-DIN-C	14.3	19.7	24.7	61.7	61	0.7	6	1
	5	□	MPS1-0360L-DIN	19.8	25.2	28.7	65.7	65	0.7	6	3
	5	●	MPS1-0360L-DIN-C	19.8	25.2	28.7	65.7	65	0.7	6	1
	2	●	MPS1-0360-PC	7.8	20.6	23.1	55.6	55	0.6	6	1
	8	●	MPS1-0360-L8C	29.5	44.7	50.7	87.7	87	0.7	6	1
	10	□	MPS1-0360-L10C	36.7	50.7	55.7	92.7	92	0.7	6	1
	12	●	MPS1-0360-L12C	43.9	58.7	63.7	100.7	100	0.7	6	1
	15	●	MPS1-0360-L15C	54.7	70.7	75.7	112.7	112	0.7	6	1
	20	●	MPS1-0360-L20C	72.7	90.7	95.7	132.7	132	0.7	6	1
	25	□	MPS1-0360-L25C	90.7	110.7	115.7	152.7	152	0.7	6	1
	30	●	MPS1-0360-L30C	108.7	130.7	135.7	172.7	172	0.7	6	1
35	□	MPS1-0360-L35C	126.7	143.7	155.7	192.7	192	0.7	6	1	
40	●	MPS1-0360-L40C	144.7	160.7	175.7	212.7	212	0.7	6	1	
3.7	3	□	MPS1-0370S-DIN	14.1	19.7	24.7	61.7	61	0.7	6	3
	3	●	MPS1-0370S-DIN-C	14.1	19.7	24.7	61.7	61	0.7	6	1
	5	□	MPS1-0370L-DIN	20.1	25.7	28.7	65.7	65	0.7	6	3
	5	●	MPS1-0370L-DIN-C	20.1	25.7	28.7	65.7	65	0.7	6	1
	2	●	MPS1-0370-PC	8.0	20.6	23.1	55.6	55	0.6	6	1
	8	●	MPS1-0370-L8C	30.4	44.8	50.8	87.8	87	0.8	6	1
	10	□	MPS1-0370-L10C	37.7	50.7	55.7	92.7	92	0.7	6	1
	12	●	MPS1-0370-L12C	45.1	58.7	63.7	100.7	100	0.7	6	1
	15	●	MPS1-0370-L15C	56.2	70.7	75.7	112.7	112	0.7	6	1
	20	●	MPS1-0370-L20C	74.7	90.7	95.7	132.7	132	0.7	6	1
	25	●	MPS1-0370-L25C	93.2	110.7	115.7	152.7	152	0.7	6	1
	30	●	MPS1-0370-L30C	111.7	130.7	135.7	172.7	172	0.7	6	1
35	□	MPS1-0370-L35C	130.2	143.7	155.7	192.7	192	0.7	6	1	
40	●	MPS1-0370-L40C	148.7	160.7	175.7	212.7	212	0.7	6	1	

DC (мм)	Глубина сверления (L/D)	DP1021	Обозначение	Размеры (мм)							Тип
				LU	LCF	LH	OAL	LF	PL	DCON	
3.8	3	□	MPS1-0380S-DIN	18.0	23.7	28.7	65.7	65	0.7	6	3
	3	●	MPS1-0380S-DIN-C	18.0	23.7	28.7	65.7	65	0.7	6	1
	5	□	MPS1-0380L-DIN	28.0	33.7	36.7	73.7	73	0.7	6	3
	5	●	MPS1-0380L-DIN-C	28.0	33.7	36.7	73.7	73	0.7	6	1
	2	●	MPS1-0380-PC	8.2	20.6	23.0	55.6	55	0.6	6	1
	8	●	MPS1-0380-L8C	31.2	44.8	50.8	87.8	87	0.8	6	1
	10	□	MPS1-0380-L10C	38.7	50.7	55.7	92.7	92	0.7	6	1
	12	●	MPS1-0380-L12C	46.3	58.7	63.7	100.7	100	0.7	6	1
	15	●	MPS1-0380-L15C	57.7	70.7	75.7	112.7	112	0.7	6	1
	20	●	MPS1-0380-L20C	76.7	90.7	95.7	132.7	132	0.7	6	1
	25	●	MPS1-0380-L25C	95.7	110.7	115.7	152.7	152	0.7	6	1
	30	●	MPS1-0380-L30C	114.7	130.7	135.7	172.7	172	0.7	6	1
35	□	MPS1-0380-L35C	133.7	150.7	155.7	192.7	192	0.7	6	1	
40	●	MPS1-0380-L40C	152.7	170.7	175.7	212.7	212	0.7	6	1	
3.9	3	□	MPS1-0390S-DIN	17.9	23.7	28.7	65.7	65	0.7	6	3
	3	●	MPS1-0390S-DIN-C	17.9	23.7	28.7	65.7	65	0.7	6	1
	5	□	MPS1-0390L-DIN	27.9	33.7	36.7	73.7	73	0.7	6	3
	5	●	MPS1-0390L-DIN-C	27.9	33.7	36.7	73.7	73	0.7	6	1
	2	●	MPS1-0390-PC	8.4	20.6	22.9	55.6	55	0.6	6	1
	8	●	MPS1-0390-L8C	32.0	44.8	50.8	87.8	87	0.8	6	1
	10	□	MPS1-0390-L10C	39.7	50.7	55.7	92.7	92	0.7	6	1
	12	●	MPS1-0390-L12C	47.5	58.7	63.7	100.7	100	0.7	6	1
	15	●	MPS1-0390-L15C	59.2	70.7	75.7	112.7	112	0.7	6	1
	20	●	MPS1-0390-L20C	78.7	90.7	95.7	132.7	132	0.7	6	1
	25	□	MPS1-0390-L25C	98.2	110.7	115.7	152.7	152	0.7	6	1
	30	●	MPS1-0390-L30C	117.7	130.7	135.7	172.7	172	0.7	6	1
35	□	MPS1-0390-L35C	137.2	150.7	155.7	192.7	192	0.7	6	1	
40	●	MPS1-0390-L40C	156.7	170.7	175.7	212.7	212	0.7	6	1	
4.0	3	□	MPS1-0400S-DIN	17.7	23.7	28.7	65.7	65	0.7	6	3
	3	●	MPS1-0400S-DIN-C	17.7	23.7	28.7	65.7	65	0.7	6	1
	5	□	MPS1-0400L-DIN	27.7	33.7	36.7	73.7	73	0.7	6	3
	5	●	MPS1-0400L-DIN-C	27.7	33.7	36.7	73.7	73	0.7	6	1
	2	●	MPS1-0400-PC	8.6	20.6	22.8	55.6	55	0.6	6	1
	8	●	MPS1-0400-L8C	32.8	44.8	50.8	87.8	87	0.8	6	1
	10	□	MPS1-0400-L10C	40.7	50.7	55.7	92.7	92	0.7	6	1
	12	●	MPS1-0400-L12C	48.7	58.7	63.7	100.7	100	0.7	6	1
	15	●	MPS1-0400-L15C	60.7	70.7	75.7	112.7	112	0.7	6	1
	20	●	MPS1-0400-L20C	80.7	90.7	95.7	132.7	132	0.7	6	1
	25	●	MPS1-0400-L25C	100.7	110.7	115.7	152.7	152	0.7	6	1
	30	●	MPS1-0400-L30C	120.7	130.7	135.7	172.7	172	0.7	6	1
35	□	MPS1-0400-L35C	140.7	150.7	155.7	192.7	192	0.7	6	1	
40	●	MPS1-0400-L40C	160.7	170.7	175.7	212.7	212	0.7	6	1	
4.05	3	□	MPS1-0405S-DIN	17.7	23.7	28.7	65.7	65	0.7	6	3
	3	●	MPS1-0405S-DIN-C	17.7	23.7	28.7	65.7	65	0.7	6	1
	5	□	MPS1-0405L-DIN	27.7	33.7	36.7	73.7	73	0.7	6	3
	5	●	MPS1-0405L-DIN-C	27.7	33.7	36.7	73.7	73	0.7	6	1

ИНСТРУМЕНТ ДЛЯ СВЕРЛЕНИЯ (МОНОЛИТНЫЕ ТВЕРДОСПЛАВНЫЕ СВЕРЛА)

MPS1

Сверхдлинные сверла с четырьмя ленточками

ТВЕРДЫЙ СПЛАВ

ИНСТРУМЕНТ ДЛЯ СВЕРЛЕНИЯ

M

DC (мм)	Глубина сверления (L/D)	DP1021	Обозначение	Размеры (мм)							Тип
				LU	LCF	LH	OAL	LF	PL	DCON	
4.1	3	□	MPS1-0410S-DIN	17.6	23.7	28.7	65.7	65	0.7	6	3
	3	●	MPS1-0410S-DIN-C	17.6	23.7	28.7	65.7	65	0.7	6	1
	5	□	MPS1-0410L-DIN	27.6	33.7	36.7	73.7	73	0.7	6	3
	5	●	MPS1-0410L-DIN-C	27.6	33.7	36.7	73.7	73	0.7	6	1
	2	●	MPS1-0410-PC	8.8	22.6	24.7	62.6	62	0.6	6	1
	8	●	MPS1-0410-L8C	33.6	50.8	55.8	92.8	92	0.8	6	1
	10	□	MPS1-0410-L10C	41.7	58.7	62.7	99.7	99	0.7	6	1
	12	●	MPS1-0410-L12C	49.9	67.7	71.7	108.7	108	0.7	6	1
	15	●	MPS1-0410-L15C	62.2	80.7	84.7	121.7	121	0.7	6	1
	20	●	MPS1-0410-L20C	82.7	103.7	107.7	144.7	144	0.7	6	1
	25	●	MPS1-0410-L25C	103.2	125.7	129.7	166.7	166	0.7	6	1
	30	●	MPS1-0410-L30C	123.7	148.7	152.7	189.7	189	0.7	6	1
35	□	MPS1-0410-L35C	144.2	164.7	174.7	211.7	211	0.7	6	1	
40	●	MPS1-0410-L40C	164.7	184.7	198.7	235.7	235	0.7	6	1	
4.2	3	□	MPS1-0420S-DIN	17.5	23.8	28.8	65.8	65	0.8	6	3
	3	●	MPS1-0420S-DIN-C	17.5	23.8	28.8	65.8	65	0.8	6	1
	5	□	MPS1-0420L-DIN	28.0	34.3	36.8	73.8	73	0.8	6	3
	5	●	MPS1-0420L-DIN-C	28.0	34.3	36.8	73.8	73	0.8	6	1
	2	●	MPS1-0420-PC	9.1	22.7	24.6	62.7	62	0.7	6	1
	8	●	MPS1-0420-L8C	34.5	50.9	55.9	92.9	92	0.9	6	1
	10	□	MPS1-0420-L10C	42.8	58.8	62.8	99.8	99	0.8	6	1
	12	●	MPS1-0420-L12C	51.2	67.8	71.8	108.8	108	0.8	6	1
	15	●	MPS1-0420-L15C	63.8	80.8	84.8	121.8	121	0.8	6	1
	20	●	MPS1-0420-L20C	84.8	103.8	107.8	144.8	144	0.8	6	1
	25	●	MPS1-0420-L25C	105.8	125.8	129.8	166.8	166	0.8	6	1
	30	●	MPS1-0420-L30C	126.8	148.8	152.8	189.8	189	0.8	6	1
35	●	MPS1-0420-L35C	147.8	164.8	174.8	211.8	211	0.8	6	1	
40	●	MPS1-0420-L40C	168.8	184.8	198.8	235.8	235	0.8	6	1	
4.3	3	□	MPS1-0430S-DIN	17.3	23.8	28.8	65.8	65	0.8	6	3
	3	●	MPS1-0430S-DIN-C	17.3	23.8	28.8	65.8	65	0.8	6	1
	5	□	MPS1-0430L-DIN	27.8	34.3	36.8	73.8	73	0.8	6	3
	5	●	MPS1-0430L-DIN-C	27.8	34.3	36.8	73.8	73	0.8	6	1
	2	●	MPS1-0430-PC	9.3	22.7	24.5	62.7	62	0.7	6	1
	8	●	MPS1-0430-L8C	35.3	50.9	55.9	92.9	92	0.9	6	1
	10	□	MPS1-0430-L10C	43.8	58.8	62.8	99.8	99	0.8	6	1
	12	●	MPS1-0430-L12C	52.4	67.8	71.8	108.8	108	0.8	6	1
	15	●	MPS1-0430-L15C	65.3	80.8	84.8	121.8	121	0.8	6	1
	20	●	MPS1-0430-L20C	86.8	103.8	107.8	144.8	144	0.8	6	1
	25	●	MPS1-0430-L25C	108.3	125.8	129.8	166.8	166	0.8	6	1
	30	●	MPS1-0430-L30C	129.8	148.8	152.8	189.8	189	0.8	6	1
35	□	MPS1-0430-L35C	151.3	170.8	174.8	211.8	211	0.8	6	1	
40	●	MPS1-0430-L40C	172.8	194.8	198.8	235.8	235	0.8	6	1	
4.4	3	□	MPS1-0440S-DIN	17.2	23.8	28.8	65.8	65	0.8	6	3
	3	●	MPS1-0440S-DIN-C	17.2	23.8	28.8	65.8	65	0.8	6	1
	5	□	MPS1-0440L-DIN	27.7	34.3	36.8	73.8	73	0.8	6	3
	5	●	MPS1-0440L-DIN-C	27.7	34.3	36.8	73.8	73	0.8	6	1
	2	●	MPS1-0440-PC	9.5	22.7	24.4	62.7	62	0.7	6	1
	8	●	MPS1-0440-L8C	36.1	50.9	55.9	92.9	92	0.9	6	1
	10	□	MPS1-0440-L10C	44.8	58.8	62.8	99.8	99	0.8	6	1
	12	●	MPS1-0440-L12C	53.6	67.8	71.8	108.8	108	0.8	6	1
	15	●	MPS1-0440-L15C	66.8	80.8	84.8	121.8	121	0.8	6	1
	20	□	MPS1-0440-L20C	88.8	103.8	107.8	144.8	144	0.8	6	1
	25	□	MPS1-0440-L25C	110.8	125.8	129.8	166.8	166	0.8	6	1
	30	□	MPS1-0440-L30C	132.8	148.8	152.8	189.8	189	0.8	6	1
35	□	MPS1-0440-L35C	154.8	170.8	174.8	211.8	211	0.8	6	1	
40	●	MPS1-0440-L40C	176.8	194.8	198.8	235.8	235	0.8	6	1	

DC (мм)	Глубина сверления (L/D)	DP1021	Обозначение	Размеры (мм)							Тип
				LU	LCF	LH	OAL	LF	PL	DCON	
4.5	3	□	MPS1-0450S-DIN	17.1	23.8	28.8	65.8	65	0.8	6	3
	3	●	MPS1-0450S-DIN-C	17.1	23.8	28.8	65.8	65	0.8	6	1
	5	□	MPS1-0450L-DIN	27.6	34.3	36.8	73.8	73	0.8	6	3
	5	●	MPS1-0450L-DIN-C	27.6	34.3	36.8	73.8	73	0.8	6	1
	2	●	MPS1-0450-PC	9.7	22.7	24.3	62.7	62	0.7	6	1
	8	●	MPS1-0450-L8C	36.9	50.9	55.9	92.9	92	0.9	6	1
	10	□	MPS1-0450-L10C	45.8	58.8	62.8	99.8	99	0.8	6	1
	12	●	MPS1-0450-L12C	54.8	67.8	71.8	108.8	108	0.8	6	1
	15	●	MPS1-0450-L15C	68.3	80.8	84.8	121.8	121	0.8	6	1
	20	●	MPS1-0450-L20C	90.8	103.8	107.8	144.8	144	0.8	6	1
	25	●	MPS1-0450-L25C	113.3	125.8	129.8	166.8	166	0.8	6	1
	30	●	MPS1-0450-L30C	135.8	148.8	152.8	189.8	189	0.8	6	1
35	□	MPS1-0450-L35C	158.3	170.8	174.8	211.8	211	0.8	6	1	
40	●	MPS1-0450-L40C	180.8	194.8	198.8	235.8	235	0.8	6	1	
4.6	3	□	MPS1-0460S-DIN	16.9	23.8	28.8	65.8	65	0.8	6	4
	3	●	MPS1-0460S-DIN-C	16.9	23.8	28.8	65.8	65	0.8	6	2
	5	□	MPS1-0460L-DIN	28.9	35.8	36.8	73.8	73	0.8	6	4
	5	●	MPS1-0460L-DIN-C	28.9	35.8	36.8	73.8	73	0.8	6	2
	2	●	MPS1-0460-PC	9.9	24.7	27.7	62.7	62	0.7	6	2
	8	●	MPS1-0460-L8C	37.8	56.0	59.0	96.0	95	1.0	6	2
	10	□	MPS1-0460-L10C	46.8	65.8	68.8	105.8	105	0.8	6	2
	12	●	MPS1-0460-L12C	56.0	75.8	78.8	115.8	115	0.8	6	2
	15	●	MPS1-0460-L15C	69.8	90.8	93.8	130.8	130	0.8	6	2
	20	●	MPS1-0460-L20C	92.8	115.8	118.8	155.8	155	0.8	6	2
	25	●	MPS1-0460-L25C	115.8	140.8	143.8	180.8	180	0.8	6	2
	30	●	MPS1-0460-L30C	138.8	165.8	168.8	205.8	205	0.8	6	2
35	□	MPS1-0460-L35C	161.8	184.8	192.8	229.8	229	0.8	6	2	
40	●	MPS1-0460-L40C	184.8	204.8	217.8	254.8	254	0.8	6	2	
4.65	3	□	MPS1-0465S-DIN	16.9	23.8	28.8	65.8	65	0.8	6	4
	3	●	MPS1-0465S-DIN-C	16.9	23.8	28.8	65.8	65	0.8	6	2
	5	□	MPS1-0465L-DIN	28.9	35.8	36.8	73.8	73	0.8	6	4
	5	●	MPS1-0465L-DIN-C	28.9	35.8	36.8	73.8	73	0.8	6	2
4.7	3	□	MPS1-0470S-DIN	16.8	23.9	28.9	65.9	65	0.9	6	4
	3	●	MPS1-0470S-DIN-C	16.8	23.9	28.9	65.9	65	0.9	6	2
	5	□	MPS1-0470L-DIN	28.8	35.9	36.9	73.9	73	0.9	6	4
	5	●	MPS1-0470L-DIN-C	28.8	35.9	36.9	73.9	73	0.9	6	2
	2	●	MPS1-0470-PC	10.1	24.7	27.7	62.7	62	0.7	6	2
	8	●	MPS1-0470-L8C	38.6	56.0	59.0	96.0	95	1.0	6	2
	10	□	MPS1-0470-L10C	47.9	65.9	68.9	105.9	105	0.9	6	2
	12	●	MPS1-0470-L12C	57.3	75.9	78.9	115.9	115	0.9	6	2
	15	●	MPS1-0470-L15C	71.4	90.9	93.9	130.9	130	0.9	6	2
	20	●	MPS1-0470-L20C	94.9	115.9	118.9	155.9	155	0.9	6	2
	25	●	MPS1-0470-L25C	118.4	140.9	143.9	180.9	180	0.9	6	2
	30	●	MPS1-0470-L30C	141.9	165.9	168.9	205.9	205	0.9	6	2
35	□	MPS1-0470-L35C	165.4	184.9	192.9	229.9	229	0.9	6	2	
40	●	MPS1-0470-L40C	188.9	204.9	217.9	254.9	254	0.9	6	2	

● : Есть на складе. □ : Нет на складе, выпускается исключительно под заказ.

DC (мм)	Глубина сверления (L/D)	DP1021	Обозначение	Размеры (мм)							Тип	
				LU	LCF	LH	OAL	LF	PL	DCON		
4.8	3	□	MPS1-0480S-DIN	20.7	27.9	28.9	65.9	65	0.9	6	4	
	3	●	MPS1-0480S-DIN-C	20.7	27.9	28.9	65.9	65	0.9	6	2	
	5	□	MPS1-0480L-DIN	36.7	43.9	44.9	81.9	81	0.9	6	4	
	5	●	MPS1-0480L-DIN-C	36.7	43.9	44.9	81.9	81	0.9	6	2	
	2	●	MPS1-0480-PC	10.4	24.8	27.8	62.8	62	0.8	6	2	
	8	●	MPS1-0480-L8C	39.4	56.0	59.0	96.0	95	1.0	6	2	
	10	□	MPS1-0480-L10C	48.9	65.9	68.9	105.9	105	0.9	6	2	
	12	●	MPS1-0480-L12C	58.5	75.9	78.9	115.9	115	0.9	6	2	
	15	●	MPS1-0480-L15C	72.9	90.9	93.9	130.9	130	0.9	6	2	
	20	●	MPS1-0480-L20C	96.9	115.9	118.9	155.9	155	0.9	6	2	
	25	●	MPS1-0480-L25C	120.9	140.9	143.9	180.9	180	0.9	6	2	
	30	●	MPS1-0480-L30C	144.9	165.9	168.9	205.9	205	0.9	6	2	
	35	□	MPS1-0480-L35C	168.9	190.9	192.9	229.9	229	0.9	6	2	
	40	●	MPS1-0480-L40C	192.9	215.9	217.9	254.9	254	0.9	6	2	
	4.9	3	□	MPS1-0490S-DIN	20.5	27.9	28.9	65.9	65	0.9	6	4
		3	●	MPS1-0490S-DIN-C	20.5	27.9	28.9	65.9	65	0.9	6	2
5		□	MPS1-0490L-DIN	36.5	43.9	44.9	81.9	81	0.9	6	4	
5		●	MPS1-0490L-DIN-C	36.5	43.9	44.9	81.9	81	0.9	6	2	
2		●	MPS1-0490-PC	10.6	24.8	27.8	62.8	62	0.8	6	2	
8		●	MPS1-0490-L8C	40.2	56.0	59.0	96.0	95	1.0	6	2	
10		□	MPS1-0490-L10C	49.9	65.9	68.9	105.9	105	0.9	6	2	
12		●	MPS1-0490-L12C	59.7	75.9	78.9	115.9	115	0.9	6	2	
15		●	MPS1-0490-L15C	74.4	90.9	93.9	130.9	130	0.9	6	2	
20		□	MPS1-0490-L20C	98.9	115.9	118.9	155.9	155	0.9	6	2	
25		●	MPS1-0490-L25C	123.4	140.9	143.9	180.9	180	0.9	6	2	
30		●	MPS1-0490-L30C	147.9	165.9	168.9	205.9	205	0.9	6	2	
35		□	MPS1-0490-L35C	172.4	190.9	192.9	229.9	229	0.9	6	2	
40		●	MPS1-0490-L40C	196.9	215.9	217.9	254.9	254	0.9	6	2	
5.0		3	□	MPS1-0500S-DIN	20.4	27.9	28.9	65.9	65	0.9	6	4
		3	●	MPS1-0500S-DIN-C	20.4	27.9	28.9	65.9	65	0.9	6	2
	5	□	MPS1-0500L-DIN	36.4	43.9	44.9	81.9	81	0.9	6	4	
	5	●	MPS1-0500L-DIN-C	36.4	43.9	44.9	81.9	81	0.9	6	2	
	2	●	MPS1-0500-PC	10.8	24.8	25.8	62.8	62	0.8	6	2	
	8	●	MPS1-0500-L8C	41.0	56.0	59.0	96.0	95	1.0	6	2	
	10	□	MPS1-0500-L10C	50.9	65.9	68.9	105.9	105	0.9	6	2	
	12	●	MPS1-0500-L12C	60.9	75.9	78.9	115.9	115	0.9	6	2	
	15	●	MPS1-0500-L15C	75.9	90.9	93.9	130.9	130	0.9	6	2	
	20	●	MPS1-0500-L20C	100.9	115.9	118.9	155.9	155	0.9	6	2	
	25	●	MPS1-0500-L25C	125.9	140.9	143.9	180.9	180	0.9	6	2	
	30	●	MPS1-0500-L30C	150.9	165.9	168.9	205.9	205	0.9	6	2	
	35	□	MPS1-0500-L35C	175.9	190.9	192.9	229.9	229	0.9	6	2	
	40	●	MPS1-0500-L40C	200.9	215.9	217.9	254.9	254	0.9	6	2	
	5.05	3	□	MPS1-0505S-DIN	20.3	27.9	28.9	65.9	65	0.9	6	4
		3	●	MPS1-0505S-DIN-C	20.3	27.9	28.9	65.9	65	0.9	6	2
5		□	MPS1-0505L-DIN	36.3	43.9	44.9	81.9	81	0.9	6	4	
5		●	MPS1-0505L-DIN-C	36.3	43.9	44.9	81.9	81	0.9	6	2	

DC (мм)	Глубина сверления (L/D)	DP1021	Обозначение	Размеры (мм)							Тип	
				LU	LCF	LH	OAL	LF	PL	DCON		
5.1	3	□	MPS1-0510S-DIN	20.3	27.9	28.9	65.9	65	0.9	6	4	
	3	●	MPS1-0510S-DIN-C	20.3	27.9	28.9	65.9	65	0.9	6	2	
	5	□	MPS1-0510L-DIN	36.3	43.9	44.9	81.9	81	0.9	6	4	
	5	●	MPS1-0510L-DIN-C	36.3	43.9	44.9	81.9	81	0.9	6	2	
	2	●	MPS1-0510-PC	11.0	26.8	28.8	66.8	66	0.8	6	2	
	8	●	MPS1-0510-L8C	41.9	62.1	65.1	102.1	101	1.1	6	2	
	10	□	MPS1-0510-L10C	51.9	72.9	75.9	112.9	112	0.9	6	2	
	12	●	MPS1-0510-L12C	62.1	83.9	86.9	123.9	123	0.9	6	2	
	15	●	MPS1-0510-L15C	77.4	99.9	102.9	139.9	139	0.9	6	2	
	20	●	MPS1-0510-L20C	102.9	127.9	130.9	167.9	167	0.9	6	2	
	25	●	MPS1-0510-L25C	128.4	154.9	157.9	194.9	194	0.9	6	2	
	30	●	MPS1-0510-L30C	153.9	182.9	185.9	222.9	222	0.9	6	2	
	35	□	MPS1-0510-L35C	179.4	203.9	211.9	248.9	248	0.9	6	2	
	40	●	MPS1-0510-L40C	204.9	230.9	241.9	278.9	278	0.9	6	2	
	5.2	3	□	MPS1-0520S-DIN	20.1	27.9	28.9	65.9	65	0.9	6	4
		3	●	MPS1-0520S-DIN-C	20.1	27.9	28.9	65.9	65	0.9	6	2
5		□	MPS1-0520L-DIN	36.1	43.9	44.9	81.9	81	0.9	6	4	
5		●	MPS1-0520L-DIN-C	36.1	43.9	44.9	81.9	81	0.9	6	2	
2		●	MPS1-0520-PC	11.2	26.8	28.8	66.8	66	0.8	6	2	
8		●	MPS1-0520-L8C	42.7	62.1	65.1	102.1	101	1.1	6	2	
10		□	MPS1-0520-L10C	52.9	72.9	75.9	112.9	112	0.9	6	2	
12		●	MPS1-0520-L12C	63.3	83.9	86.9	123.9	123	0.9	6	2	
15		●	MPS1-0520-L15C	78.9	99.9	102.9	139.9	139	0.9	6	2	
20		●	MPS1-0520-L20C	104.9	127.9	130.9	167.9	167	0.9	6	2	
25		●	MPS1-0520-L25C	130.9	154.9	157.9	194.9	194	0.9	6	2	
30		●	MPS1-0520-L30C	156.9	182.9	185.9	222.9	222	0.9	6	2	
35		□	MPS1-0520-L35C	182.9	203.9	211.9	248.9	248	0.9	6	2	
40		●	MPS1-0520-L40C	208.9	230.9	241.9	278.9	278	0.9	6	2	
5.3		3	□	MPS1-0530S-DIN	20.0	28.0	29.0	66.0	65	1.0	6	4
		3	●	MPS1-0530S-DIN-C	20.0	28.0	29.0	66.0	65	1.0	6	2
	5	□	MPS1-0530L-DIN	36.0	44.0	45.0	82.0	81	1.0	6	4	
	5	●	MPS1-0530L-DIN-C	36.0	44.0	45.0	82.0	81	1.0	6	2	
	2	●	MPS1-0530-PC	11.4	26.8	28.8	66.8	66	0.8	6	2	
	8	●	MPS1-0530-L8C	43.5	62.1	65.1	102.1	101	1.1	6	2	
	10	□	MPS1-0530-L10C	54.0	73.0	76.0	113.0	112	1.0	6	2	
	12	●	MPS1-0530-L12C	64.6	84.0	87.0	124.0	123	1.0	6	2	
	15	●	MPS1-0530-L15C	80.5	100.0	103.0	140.0	139	1.0	6	2	
	20	□	MPS1-0530-L20C	107.0	128.0	131.0	168.0	167	1.0	6	2	
	25	●	MPS1-0530-L25C	133.5	155.0	158.0	195.0	194	1.0	6	2	
	30	●	MPS1-0530-L30C	160.0	183.0	186.0	223.0	222	1.0	6	2	
	35	□	MPS1-0530-L35C	186.5	210.0	212.0	249.0	248	1.0	6	2	
	40	●	MPS1-0530-L40C	213.0	241.0	242.0	279.0	278	1.0	6	2	
	5.4	3	□	MPS1-0540S-DIN	19.9	28.0	29.0	66.0	65	1.0	6	2
		3	●	MPS1-0540S-DIN-C	19.9	28.0	29.0	66.0	65	1.0	6	2
5		□	MPS1-0540L-DIN	35.9	44.0	45.0	82.0	81	1.0	6	4	
5		●	MPS1-0540L-DIN-C	35.9	44.0	45.0	82.0	81	1.0	6	2	
2		●	MPS1-0540-PC	11.7	26.9	28.9	66.9	66	0.9	6	2	
8		●	MPS1-0540-L8C	44.3	62.1	65.1	102.1	101	1.1	6	2	
10		□	MPS1-0540-L10C	55.0	73.0	76.0	113.0	112	1.0	6	2	
12		●	MPS1-0540-L12C	65.8	84.0	87.0	124.0	123	1.0	6	2	
15		●	MPS1-0540-L15C	82.0	100.0	103.0	140.0	139	1.0	6	2	
20		●	MPS1-0540-L20C	109.0	128.0	131.0	168.0	167	1.0	6	2	
25		□	MPS1-0540-L25C	136.0	155.0	158.0	195.0	194	1.0	6	2	
30		□	MPS1-0540-L30C	163.0	183.0	186.0	223.0	222	1.0	6	2	
35		□	MPS1-0540-L35C	190.0	210.0	212.0	249.0	248	1.0	6	2	
40		●	MPS1-0540-L40C	217.0	241.0	242.0	279.0	278	1.0	6	2	

М
ИНСТРУМЕНТ ДЛЯ
СВЕРЛЕНИЯ

ИНСТРУМЕНТ ДЛЯ СВЕРЛЕНИЯ (МОНОЛИТНЫЕ ТВЕРДОСПЛАВНЫЕ СВЕРЛА)

MPS1

Сверхдлинные сверла с четырьмя ленточками

ТВЕРДЫЙ СПЛАВ

ИНСТРУМЕНТ ДЛЯ СВЕРЛЕНИЯ

M

DC (мм)	Глубина сверления (L/D)	DP1021	Обозначение	Размеры (мм)							Тип
				LU	LCF	LH	OAL	LF	PL	DCON	
5.5	3	□	MPS1-0550S-DIN	19.8	28.0	29.0	66.0	65	1.0	6	4
	3	●	MPS1-0550S-DIN-C	19.8	28.0	29.0	66.0	65	1.0	6	2
	5	□	MPS1-0550L-DIN	35.8	44.0	45.0	82.0	81	1.0	6	4
	5	●	MPS1-0550L-DIN-C	35.8	44.0	45.0	82.0	81	1.0	6	2
	2	●	MPS1-0550-PC	11.9	26.9	28.9	66.9	66	0.9	6	2
	8	●	MPS1-0550-L8C	45.1	62.1	65.1	102.1	101	1.1	6	2
	10	□	MPS1-0550-L10C	56.0	73.0	76.0	113.0	112	1.0	6	2
	12	●	MPS1-0550-L12C	67.0	84.0	87.0	124.0	123	1.0	6	2
	15	●	MPS1-0550-L15C	83.5	100.0	103.0	140.0	139	1.0	6	2
	20	●	MPS1-0550-L20C	111.0	128.0	131.0	168.0	167	1.0	6	2
	25	●	MPS1-0550-L25C	138.5	155.0	158.0	195.0	194	1.0	6	2
	30	●	MPS1-0550-L30C	166.0	183.0	186.0	223.0	222	1.0	6	2
35	□	MPS1-0550-L35C	193.5	210.0	212.0	249.0	248	1.0	6	2	
40	●	MPS1-0550-L40C	221.0	241.0	242.0	279.0	278	1.0	6	2	
5.55	3	□	MPS1-0555S-DIN	19.7	28.0	29.0	66.0	65	1.0	6	4
	3	●	MPS1-0555S-DIN-C	19.7	28.0	29.0	66.0	65	1.0	6	2
	5	□	MPS1-0555L-DIN	35.7	44.0	45.0	82.0	81	1.0	6	4
	5	●	MPS1-0555L-DIN-C	35.7	44.0	45.0	82.0	81	1.0	6	2
5.6	3	□	MPS1-0560S-DIN	19.6	28.0	29.0	66.0	65	1.0	6	4
	3	●	MPS1-0560S-DIN-C	19.6	28.0	29.0	66.0	65	1.0	6	2
	5	□	MPS1-0560L-DIN	35.6	44.0	45.0	82.0	81	1.0	6	4
	5	●	MPS1-0560L-DIN-C	35.6	44.0	45.0	82.0	81	1.0	6	2
	2	●	MPS1-0560-PC	12.1	28.9	28.9	66.9	66	0.9	6	2
	8	●	MPS1-0560-L8C	46.0	67.2	70.2	107.2	106	1.2	6	2
	10	□	MPS1-0560-L10C	57.0	79.0	82.0	119.0	118	1.0	6	2
	12	●	MPS1-0560-L12C	68.2	91.0	94.0	131.0	130	1.0	6	2
	15	●	MPS1-0560-L15C	85.0	109.0	112.0	149.0	148	1.0	6	2
	20	□	MPS1-0560-L20C	113.0	139.0	142.0	179.0	178	1.0	6	2
	25	□	MPS1-0560-L25C	141.0	169.0	172.0	209.0	208	1.0	6	2
	30	●	MPS1-0560-L30C	169.0	199.0	202.0	239.0	238	1.0	6	2
35	□	MPS1-0560-L35C	197.0	223.0	231.0	268.0	267	1.0	6	2	
40	●	MPS1-0560-L40C	225.0	251.0	262.0	299.0	298	1.0	6	2	
5.7	3	□	MPS1-0570S-DIN	19.5	28.0	29.0	66.0	65	1.0	6	4
	3	●	MPS1-0570S-DIN-C	19.5	28.0	29.0	66.0	65	1.0	6	2
	5	□	MPS1-0570L-DIN	35.5	44.0	45.0	82.0	81	1.0	6	4
	5	●	MPS1-0570L-DIN-C	35.5	44.0	45.0	82.0	81	1.0	6	2
	2	●	MPS1-0570-PC	12.3	28.9	28.9	66.9	66	0.9	6	2
	8	●	MPS1-0570-L8C	46.8	67.2	70.2	107.2	106	1.2	6	2
	10	□	MPS1-0570-L10C	58.0	79.0	82.0	119.0	118	1.0	6	2
	12	●	MPS1-0570-L12C	69.4	91.0	94.0	131.0	130	1.0	6	2
	15	●	MPS1-0570-L15C	86.5	109.0	112.0	149.0	148	1.0	6	2
	20	□	MPS1-0570-L20C	115.0	139.0	142.0	179.0	178	1.0	6	2
	25	●	MPS1-0570-L25C	143.5	169.0	172.0	209.0	208	1.0	6	2
	30	□	MPS1-0570-L30C	172.0	199.0	202.0	239.0	238	1.0	6	2
35	□	MPS1-0570-L35C	200.5	223.0	231.0	268.0	267	1.0	6	2	
40	●	MPS1-0570-L40C	229.0	251.0	262.0	299.0	298	1.0	6	2	

DC (мм)	Глубина сверления (L/D)	DP1021	Обозначение	Размеры (мм)							Тип
				LU	LCF	LH	OAL	LF	PL	DCON	
5.8	3	□	MPS1-0580S-DIN	19.4	28.1	29.1	66.1	65	1.1	6	4
	3	●	MPS1-0580S-DIN-C	19.4	28.1	29.1	66.1	65	1.1	6	2
	5	□	MPS1-0580L-DIN	35.4	44.1	45.1	82.1	81	1.1	6	4
	5	●	MPS1-0580L-DIN-C	35.4	44.1	45.1	82.1	81	1.1	6	2
	2	●	MPS1-0580-PC	12.5	28.9	28.9	66.9	66	0.9	6	2
	8	●	MPS1-0580-L8C	47.6	67.2	70.2	107.2	106	1.2	6	2
	10	□	MPS1-0580-L10C	59.1	79.1	82.1	119.1	118	1.1	6	2
	12	●	MPS1-0580-L12C	70.7	91.1	94.1	131.1	130	1.1	6	2
	15	●	MPS1-0580-L15C	88.1	109.1	112.1	149.1	148	1.1	6	2
	20	●	MPS1-0580-L20C	117.1	139.1	142.1	179.1	178	1.1	6	2
	25	□	MPS1-0580-L25C	146.1	169.1	172.1	209.1	208	1.1	6	2
	30	●	MPS1-0580-L30C	175.1	199.1	202.1	239.1	238	1.1	6	2
35	□	MPS1-0580-L35C	204.1	229.1	231.1	268.1	267	1.1	6	2	
40	●	MPS1-0580-L40C	233.1	261.1	262.1	299.1	298	1.1	6	2	
5.9	3	□	MPS1-0590S-DIN	19.2	28.1	29.1	66.1	65	1.1	6	4
	3	●	MPS1-0590S-DIN-C	19.2	28.1	29.1	66.1	65	1.1	6	2
	5	□	MPS1-0590L-DIN	35.2	44.1	45.1	82.1	81	1.1	6	4
	5	●	MPS1-0590L-DIN-C	35.2	44.1	45.1	82.1	81	1.1	6	2
	2	●	MPS1-0590-PC	12.7	28.9	28.9	66.9	66	0.9	6	2
	8	●	MPS1-0590-L8C	48.4	67.2	70.2	107.2	106	1.2	6	2
	10	□	MPS1-0590-L10C	60.1	79.1	82.1	119.1	118	1.1	6	2
	12	●	MPS1-0590-L12C	71.9	91.1	94.1	131.1	130	1.1	6	2
	15	●	MPS1-0590-L15C	89.6	109.1	112.1	149.1	148	1.1	6	2
	20	●	MPS1-0590-L20C	119.1	139.1	142.1	179.1	178	1.1	6	2
	25	●	MPS1-0590-L25C	148.6	169.1	172.1	209.1	208	1.1	6	2
	30	□	MPS1-0590-L30C	178.1	199.1	202.1	239.1	238	1.1	6	2
35	□	MPS1-0590-L35C	207.6	229.1	231.1	268.1	267	1.1	6	2	
40	●	MPS1-0590-L40C	237.1	261.1	262.1	299.1	298	1.1	6	2	
6.0	3	□	MPS1-0600S-DIN	19.1	28.1	29.1	66.1	65	1.1	6	4
	3	●	MPS1-0600S-DIN-C	19.1	28.1	29.1	66.1	65	1.1	6	2
	5	□	MPS1-0600L-DIN	35.1	44.1	45.1	82.1	81	1.1	6	4
	5	●	MPS1-0600L-DIN-C	35.1	44.1	45.1	82.1	81	1.1	6	2
	2	●	MPS1-0600-PC	12.9	28.9	28.9	66.9	66	0.9	6	2
	8	●	MPS1-0600-L8C	49.2	67.2	70.2	107.2	106	1.2	6	2
	10	□	MPS1-0600-L10C	61.1	79.1	82.1	119.1	118	1.1	6	2
	12	●	MPS1-0600-L12C	73.1	91.1	94.1	131.1	130	1.1	6	2
	15	●	MPS1-0600-L15C	91.1	109.1	112.1	149.1	148	1.1	6	2
	20	●	MPS1-0600-L20C	121.1	139.1	142.1	179.1	178	1.1	6	2
	25	●	MPS1-0600-L25C	151.1	169.1	172.1	209.1	208	1.1	6	2
	30	●	MPS1-0600-L30C	181.1	199.1	202.1	239.1	238	1.1	6	2
35	□	MPS1-0600-L35C	211.1	229.1	231.1	268.1	267	1.1	6	2	
40	●	MPS1-0600-L40C	241.1	261.1	262.1	299.1	298	1.1	6	2	
6.05	3	□	MPS1-0605S-DIN	25.0	34.1	42.1	79.1	78	1.1	8	4
	3	●	MPS1-0605S-DIN-C	25.0	34.1	42.1	79.1	78	1.1	8	2
	5	□	MPS1-0605L-DIN	44.0	53.1	54.1	91.1	90	1.1	8	4
	5	●	MPS1-0605L-DIN-C	44.0	53.1	54.1	91.1	90	1.1	8	2

● : Есть на складе. □ : Нет на складе, выпускается исключительно под заказ.

DC (мм)	Глубина сверления (L/D)	DP1021	Обозначение	Размеры (мм)							Тип	
				LU	LCF	LH	OAL	LF	PL	DCON		
6.1	3	□	MPS1-0610S-DIN	25.0	34.1	42.1	79.1	78	1.1	8	4	
	3	●	MPS1-0610S-DIN-C	25.0	34.1	42.1	79.1	78	1.1	8	2	
	5	□	MPS1-0610L-DIN	44.0	53.1	54.1	91.1	90	1.1	8	4	
	5	●	MPS1-0610L-DIN-C	44.0	53.1	54.1	91.1	90	1.1	8	2	
	2	●	MPS1-0610-PC	13.2	32.0	35.0	75.0	74	1.0	8	2	
	8	●	MPS1-0610-L8C	50.1	73.3	76.3	113.3	112	1.3	8	2	
	10	□	MPS1-0610-L10C	62.1	86.1	89.1	126.1	125	1.1	8	2	
	12	●	MPS1-0610-L12C	74.3	99.1	102.1	139.1	138	1.1	8	2	
	15	●	MPS1-0610-L15C	92.6	118.1	121.1	158.1	157	1.1	8	2	
	20	●	MPS1-0610-L20C	123.1	151.1	154.1	191.1	190	1.1	8	2	
	25	●	MPS1-0610-L25C	153.6	183.1	186.1	223.1	222	1.1	8	2	
	30	●	MPS1-0610-L30C	184.1	216.1	219.1	256.1	255	1.1	8	2	
	35	□	MPS1-0610-L35C	214.6	241.1	250.1	287.1	286	1.1	8	2	
	40	●	MPS1-0610-L40C	245.1	271.1	284.1	321.1	320	1.1	8	2	
	6.2	3	□	MPS1-0620S-DIN	24.8	34.1	42.1	79.1	78	1.1	8	4
		3	●	MPS1-0620S-DIN-C	24.8	34.1	42.1	79.1	78	1.1	8	2
5		□	MPS1-0620L-DIN	43.8	53.1	54.1	91.1	90	1.1	8	4	
5		●	MPS1-0620L-DIN-C	43.8	53.1	54.1	91.1	90	1.1	8	2	
2		●	MPS1-0620-PC	13.4	32.0	35.0	75.0	74	1.0	8	2	
8		●	MPS1-0620-L8C	50.9	73.3	76.3	113.3	112	1.3	8	2	
10		□	MPS1-0620-L10C	63.1	86.1	89.1	126.1	125	1.1	8	2	
12		●	MPS1-0620-L12C	75.5	99.1	102.1	139.1	138	1.1	8	2	
15		●	MPS1-0620-L15C	94.1	118.1	121.1	158.1	157	1.1	8	2	
20		●	MPS1-0620-L20C	125.1	151.1	154.1	191.1	190	1.1	8	2	
25		□	MPS1-0620-L25C	156.1	183.1	186.1	223.1	222	1.1	8	2	
30		●	MPS1-0620-L30C	187.1	216.1	219.1	256.1	255	1.1	8	2	
35		□	MPS1-0620-L35C	218.1	241.1	250.1	287.1	286	1.1	8	2	
40		●	MPS1-0620-L40C	249.1	271.1	284.1	321.1	320	1.1	8	2	
6.3		3	□	MPS1-0630S-DIN	24.7	34.1	42.1	79.1	78	1.1	8	4
		3	●	MPS1-0630S-DIN-C	24.7	34.1	42.1	79.1	78	1.1	8	2
	5	□	MPS1-0630L-DIN	43.7	53.1	54.1	91.1	90	1.1	8	4	
	5	●	MPS1-0630L-DIN-C	43.7	53.1	54.1	91.1	90	1.1	8	2	
	2	●	MPS1-0630-PC	13.6	32.0	35.0	75.0	74	1.0	8	2	
	8	●	MPS1-0630-L8C	51.7	73.3	76.3	113.3	112	1.3	8	2	
	10	□	MPS1-0630-L10C	64.1	86.1	89.1	126.1	125	1.1	8	2	
	12	●	MPS1-0630-L12C	76.7	99.1	102.1	139.1	138	1.1	8	2	
	15	●	MPS1-0630-L15C	95.6	118.1	121.1	158.1	157	1.1	8	2	
	20	●	MPS1-0630-L20C	127.1	151.1	154.1	191.1	190	1.1	8	2	
	25	□	MPS1-0630-L25C	158.6	183.1	186.1	223.1	222	1.1	8	2	
	30	●	MPS1-0630-L30C	190.1	216.1	219.1	256.1	255	1.1	8	2	
	35	□	MPS1-0630-L35C	221.6	248.1	250.1	287.1	286	1.1	8	2	
	40	●	MPS1-0630-L40C	253.1	281.1	284.1	321.1	320	1.1	8	2	
	6.4	3	□	MPS1-0640S-DIN	24.6	34.2	42.2	79.2	78	1.2	8	4
		3	●	MPS1-0640S-DIN-C	24.6	34.2	42.2	79.2	78	1.2	8	2
5		□	MPS1-0640L-DIN	43.6	53.2	54.2	91.2	90	1.2	8	4	
5		●	MPS1-0640L-DIN-C	43.6	53.2	54.2	91.2	90	1.2	8	2	
2		●	MPS1-0640-PC	13.8	32.0	35.0	75.0	74	1.0	8	2	
8		●	MPS1-0640-L8C	52.5	73.3	76.3	113.3	112	1.3	8	2	
10		□	MPS1-0640-L10C	65.2	86.2	89.2	126.2	125	1.2	8	2	
12		●	MPS1-0640-L12C	78.0	99.2	102.2	139.2	138	1.2	8	2	
15		●	MPS1-0640-L15C	97.2	118.2	121.2	158.2	157	1.2	8	2	
20		●	MPS1-0640-L20C	129.2	151.2	154.2	191.2	190	1.2	8	2	
25		●	MPS1-0640-L25C	161.2	183.2	186.2	223.2	222	1.2	8	2	
30		●	MPS1-0640-L30C	193.2	216.2	219.2	256.2	255	1.2	8	2	
35		□	MPS1-0640-L35C	225.2	248.2	250.2	287.2	286	1.2	8	2	
40		●	MPS1-0640-L40C	257.2	281.2	284.2	321.2	320	1.2	8	2	

DC (мм)	Глубина сверления (L/D)	DP1021	Обозначение	Размеры (мм)							Тип	
				LU	LCF	LH	OAL	LF	PL	DCON		
6.5	3	□	MPS1-0650S-DIN	24.4	34.2	42.2	79.2	78	1.2	8	4	
	3	●	MPS1-0650S-DIN-C	24.4	34.2	42.2	79.2	78	1.2	8	2	
	5	□	MPS1-0650L-DIN	43.4	53.2	54.2	91.2	90	1.2	8	4	
	5	●	MPS1-0650L-DIN-C	43.4	53.2	54.2	91.2	90	1.2	8	2	
	2	●	MPS1-0650-PC	14.0	32.0	35.0	75.0	74	1.0	8	2	
	8	●	MPS1-0650-L8C	53.3	73.3	76.3	113.3	112	1.3	8	2	
	10	□	MPS1-0650-L10C	66.2	86.2	89.2	126.2	125	1.2	8	2	
	12	●	MPS1-0650-L12C	79.2	99.2	102.2	139.2	138	1.2	8	2	
	15	●	MPS1-0650-L15C	98.7	118.2	121.2	158.2	157	1.2	8	2	
	20	●	MPS1-0650-L20C	131.2	151.2	154.2	191.2	190	1.2	8	2	
	25	●	MPS1-0650-L25C	163.7	183.2	186.2	223.2	222	1.2	8	2	
	30	●	MPS1-0650-L30C	196.2	216.2	219.2	256.2	255	1.2	8	2	
	35	□	MPS1-0650-L35C	228.7	248.2	250.2	287.2	286	1.2	8	2	
	40	●	MPS1-0650-L40C	261.2	281.2	284.2	321.2	320	1.2	8	2	
	6.6	3	□	MPS1-0660S-DIN	24.3	34.2	42.2	79.2	78	1.2	8	4
		3	●	MPS1-0660S-DIN-C	24.3	34.2	42.2	79.2	78	1.2	8	2
5		□	MPS1-0660L-DIN	43.3	53.2	54.2	91.2	90	1.2	8	4	
5		●	MPS1-0660L-DIN-C	43.3	53.2	54.2	91.2	90	1.2	8	2	
2		●	MPS1-0660-PC	14.2	35.0	37.0	75.0	74	1.0	8	2	
8		●	MPS1-0660-L8C	54.2	78.4	81.4	118.4	117	1.4	8	2	
10		□	MPS1-0660-L10C	67.2	92.2	95.2	132.2	131	1.2	8	2	
12		●	MPS1-0660-L12C	80.4	106.2	109.2	146.2	145	1.2	8	2	
15		●	MPS1-0660-L15C	100.2	127.2	130.2	167.2	166	1.2	8	2	
20		□	MPS1-0660-L20C	133.2	162.2	165.2	202.2	201	1.2	8	2	
25		●	MPS1-0660-L25C	166.2	197.2	200.2	237.2	236	1.2	8	2	
30		●	MPS1-0660-L30C	199.2	232.2	235.2	272.2	271	1.2	8	2	
35		□	MPS1-0660-L35C	232.2	267.2	269.2	306.2	305	1.2	8	2	
40		●	MPS1-0660-L40C	265.2	301.2	304.2	341.2	340	1.2	8	2	
6.7		3	□	MPS1-0670S-DIN	24.2	34.2	42.2	79.2	78	1.2	8	4
		3	●	MPS1-0670S-DIN-C	24.2	34.2	42.2	79.2	78	1.2	8	2
	5	□	MPS1-0670L-DIN	43.2	53.2	54.2	91.2	90	1.2	8	4	
	5	●	MPS1-0670L-DIN-C	43.2	53.2	54.2	91.2	90	1.2	8	2	
	2	●	MPS1-0670-PC	14.5	35.1	37.1	75.1	74	1.1	8	2	
	8	●	MPS1-0670-L8C	55.0	78.4	81.4	118.4	117	1.4	8	2	
	10	□	MPS1-0670-L10C	68.2	92.2	95.2	132.2	131	1.2	8	2	
	12	●	MPS1-0670-L12C	81.6	106.2	109.2	146.2	145	1.2	8	2	
	15	●	MPS1-0670-L15C	101.7	127.2	130.2	167.2	166	1.2	8	2	
	20	□	MPS1-0670-L20C	135.2	162.2	165.2	202.2	201	1.2	8	2	
	25	□	MPS1-0670-L25C	168.7	197.2	200.2	237.2	236	1.2	8	2	
	30	●	MPS1-0670-L30C	202.2	232.2	235.2	272.2	271	1.2	8	2	
	35	□	MPS1-0670-L35C	235.7	267.2	269.2	306.2	305	1.2	8	2	
	40	●	MPS1-0670-L40C	269.2	301.2	304.2	341.2	340	1.2	8	2	
	6.8	3	□	MPS1-0680S-DIN	24.0	34.2	42.2	79.2	78	1.2	8	4
		3	●	MPS1-0680S-DIN-C	24.0	34.2	42.2	79.2	78	1.2	8	2
5		□	MPS1-0680L-DIN	43.0	53.2	54.2	91.2	90	1.2	8	4	
5		●	MPS1-0680L-DIN-C	43.0	53.2	54.2	91.2	90	1.2	8	2	
2		●	MPS1-0680-PC	14.7	35.1	37.1	75.1	74	1.1	8	2	
8		●	MPS1-0680-L8C	55.8	78.4	81.4	118.4	117	1.4	8	2	
10		□	MPS1-0680-L10C	69.2	92.2	95.2	132.2	131	1.2	8	2	
12		●	MPS1-0680-L12C	82.8	106.2	109.2	146.2	145	1.2	8	2	
15		●	MPS1-0680-L15C	103.2	127.2	130.2	167.2	166	1.2	8	2	
20		●	MPS1-0680-L20C	137.2	162.2	165.2	202.2	201	1.2	8	2	
25		●	MPS1-0680-L25C	171.2	197.2	200.2	237.2	236	1.2	8	2	
30		●	MPS1-0680-L30C	205.2	232.2	235.2	272.2	271	1.2	8	2	
35		□	MPS1-0680-L35C	239.2	267.2	269.2	306.2	305	1.2	8	2	
40		●	MPS1-0680-L40C	273.2	301.2	304.2	341.2	340	1.2	8	2	

М
ИНСТРУМЕНТ ДЛЯ
СВЕРЛЕНИЯ

ИНСТРУМЕНТ ДЛЯ СВЕРЛЕНИЯ (МОНОЛИТНЫЕ ТВЕРДОСПЛАВНЫЕ СВЕРЛА)

MPS1

Сверхдлинные сверла с четырьмя ленточками

ТВЕРДЫЙ СПЛАВ

ИНСТРУМЕНТ ДЛЯ СВЕРЛЕНИЯ

M

DC (мм)	Глубина сверления (L/D)	DP1021	Обозначение	Размеры (мм)							Тип
				LU	LCF	LH	OAL	LF	PL	DCON	
6.9	3	□	MPS1-0690S-DIN	23.9	34.3	42.3	79.3	78	1.3	8	4
	3	●	MPS1-0690S-DIN-C	23.9	34.3	42.3	79.3	78	1.3	8	2
	5	□	MPS1-0690L-DIN	42.9	53.3	54.3	91.3	90	1.3	8	4
	5	●	MPS1-0690L-DIN-C	42.9	53.3	54.3	91.3	90	1.3	8	2
	2	●	MPS1-0690-PC	14.9	35.1	37.1	75.1	74	1.1	8	2
	8	●	MPS1-0690-L8C	56.6	78.4	81.4	118.4	117	1.4	8	2
	10	□	MPS1-0690-L10C	70.3	92.3	95.3	132.3	131	1.3	8	2
	12	●	MPS1-0690-L12C	84.1	106.3	109.3	146.3	145	1.3	8	2
	15	●	MPS1-0690-L15C	104.8	127.3	130.3	167.3	166	1.3	8	2
	20	●	MPS1-0690-L20C	139.3	162.3	165.3	202.3	201	1.3	8	2
	25	●	MPS1-0690-L25C	173.8	197.3	200.3	237.3	236	1.3	8	2
	30	●	MPS1-0690-L30C	208.3	232.3	235.3	272.3	271	1.3	8	2
35	□	MPS1-0690-L35C	242.8	267.3	269.3	306.3	305	1.3	8	2	
40	●	MPS1-0690-L40C	277.3	301.3	304.3	341.3	340	1.3	8	2	
7.0	3	□	MPS1-0700S-DIN	23.8	34.3	42.3	79.3	78	1.3	8	4
	3	●	MPS1-0700S-DIN-C	23.8	34.3	42.3	79.3	78	1.3	8	2
	5	□	MPS1-0700L-DIN	42.8	53.3	54.3	91.3	90	1.3	8	4
	5	●	MPS1-0700L-DIN-C	42.8	53.3	54.3	91.3	90	1.3	8	2
	2	●	MPS1-0700-PC	15.1	35.1	37.1	75.1	74	1.1	8	2
	8	●	MPS1-0700-L8C	57.4	78.4	81.4	118.4	117	1.4	8	2
	10	●	MPS1-0700-L10C	71.3	92.3	95.3	132.3	131	1.3	8	2
	12	●	MPS1-0700-L12C	85.3	106.3	109.3	146.3	145	1.3	8	2
	15	●	MPS1-0700-L15C	106.3	127.3	130.3	167.3	166	1.3	8	2
	20	●	MPS1-0700-L20C	141.3	162.3	165.3	202.3	201	1.3	8	2
	25	●	MPS1-0700-L25C	176.3	197.3	200.3	237.3	236	1.3	8	2
	30	●	MPS1-0700-L30C	211.3	232.3	235.3	272.3	271	1.3	8	2
35	□	MPS1-0700-L35C	246.3	267.3	269.3	306.3	305	1.3	8	2	
40	●	MPS1-0700-L40C	281.3	301.3	304.3	341.3	340	1.3	8	2	
7.1	3	□	MPS1-0710S-DIN	30.6	41.3	42.3	79.3	78	1.3	8	4
	3	●	MPS1-0710S-DIN-C	30.6	41.3	42.3	79.3	78	1.3	8	2
	5	□	MPS1-0710L-DIN	42.6	53.3	54.3	91.3	90	1.3	8	4
	5	●	MPS1-0710L-DIN-C	42.6	53.3	54.3	91.3	90	1.3	8	2
	2	●	MPS1-0710-PC	15.3	35.1	38.1	80.1	79	1.1	8	2
	8	●	MPS1-0710-L8C	58.3	84.5	87.5	124.5	123	1.5	8	2
	10	□	MPS1-0710-L10C	72.3	99.3	102.3	139.3	138	1.3	8	2
	12	●	MPS1-0710-L12C	86.5	114.3	117.3	154.3	153	1.3	8	2
	15	●	MPS1-0710-L15C	107.8	136.3	139.3	176.3	175	1.3	8	2
	20	●	MPS1-0710-L20C	143.3	174.3	177.3	214.3	213	1.3	8	2
	25	●	MPS1-0710-L25C	178.8	211.3	214.3	251.3	250	1.3	8	2
	30	●	MPS1-0710-L30C	214.3	249.3	252.3	289.3	288	1.3	8	2
35	□	MPS1-0710-L35C	249.8	286.3	288.3	325.3	324	1.3	8	2	
40	●	MPS1-0710-L40C	285.3	321.3	323.3	360.3	359	1.3	8	2	
7.2	3	□	MPS1-0720S-DIN	30.5	41.3	42.3	79.3	78	1.3	8	4
	3	●	MPS1-0720S-DIN-C	30.5	41.3	42.3	79.3	78	1.3	8	2
	5	□	MPS1-0720L-DIN	42.5	53.3	54.3	91.3	90	1.3	8	4
	5	●	MPS1-0720L-DIN-C	42.5	53.3	54.3	91.3	90	1.3	8	2
	2	●	MPS1-0720-PC	15.5	35.1	38.1	80.1	79	1.1	8	2
	8	●	MPS1-0720-L8C	59.1	84.5	87.5	124.5	123	1.5	8	2
	10	□	MPS1-0720-L10C	73.3	99.3	102.3	139.3	138	1.3	8	2
	12	●	MPS1-0720-L12C	87.7	114.3	117.3	154.3	153	1.3	8	2
	15	□	MPS1-0720-L15C	109.3	136.3	139.3	176.3	175	1.3	8	2
	20	□	MPS1-0720-L20C	145.3	174.3	177.3	214.3	213	1.3	8	2
	25	□	MPS1-0720-L25C	181.3	211.3	214.3	251.3	250	1.3	8	2
	30	□	MPS1-0720-L30C	217.3	249.3	252.3	289.3	288	1.3	8	2
35	□	MPS1-0720-L35C	253.3	286.3	288.3	325.3	324	1.3	8	2	
40	●	MPS1-0720-L40C	289.3	321.3	323.3	360.3	359	1.3	8	2	

DC (мм)	Глубина сверления (L/D)	DP1021	Обозначение	Размеры (мм)							Тип
				LU	LCF	LH	OAL	LF	PL	DCON	
7.3	3	□	MPS1-0730S-DIN	30.4	41.3	42.3	79.3	78	1.3	8	4
	3	●	MPS1-0730S-DIN-C	30.4	41.3	42.3	79.3	78	1.3	8	2
	5	□	MPS1-0730L-DIN	42.4	53.3	54.3	91.3	90	1.3	8	4
	5	●	MPS1-0730L-DIN-C	42.4	53.3	54.3	91.3	90	1.3	8	2
	2	●	MPS1-0730-PC	15.8	35.2	38.2	80.2	79	1.2	8	2
	8	●	MPS1-0730-L8C	59.9	84.5	87.5	124.5	123	1.5	8	2
	10	□	MPS1-0730-L10C	74.3	99.3	102.3	139.3	138	1.3	8	2
	12	●	MPS1-0730-L12C	88.9	114.3	117.3	154.3	153	1.3	8	2
	15	□	MPS1-0730-L15C	110.8	136.3	139.3	176.3	175	1.3	8	2
	20	□	MPS1-0730-L20C	147.3	174.3	177.3	214.3	213	1.3	8	2
	25	□	MPS1-0730-L25C	183.8	211.3	214.3	251.3	250	1.3	8	2
	30	□	MPS1-0730-L30C	220.3	249.3	252.3	289.3	288	1.3	8	2
35	□	MPS1-0730-L35C	256.8	286.3	288.3	325.3	324	1.3	8	2	
40	●	MPS1-0730-L40C	293.3	321.3	323.3	360.3	359	1.3	8	2	
7.4	3	□	MPS1-0740S-DIN	30.2	41.3	42.3	79.3	78	1.3	8	4
	3	●	MPS1-0740S-DIN-C	30.2	41.3	42.3	79.3	78	1.3	8	2
	5	□	MPS1-0740L-DIN	42.2	53.3	54.3	91.3	90	1.3	8	4
	5	●	MPS1-0740L-DIN-C	42.2	53.3	54.3	91.3	90	1.3	8	2
	2	●	MPS1-0740-PC	16.0	35.2	38.2	80.2	79	1.2	8	2
	8	●	MPS1-0740-L8C	60.7	84.5	87.5	124.5	123	1.5	8	2
	10	□	MPS1-0740-L10C	75.3	99.3	102.3	139.3	138	1.3	8	2
	12	●	MPS1-0740-L12C	90.1	114.3	117.3	154.3	153	1.3	8	2
	15	□	MPS1-0740-L15C	112.3	136.3	139.3	176.3	175	1.3	8	2
	20	□	MPS1-0740-L20C	149.3	174.3	177.3	214.3	213	1.3	8	2
	25	□	MPS1-0740-L25C	186.3	211.3	214.3	251.3	250	1.3	8	2
	30	□	MPS1-0740-L30C	223.3	249.3	252.3	289.3	288	1.3	8	2
35	□	MPS1-0740-L35C	260.3	286.3	288.3	325.3	324	1.3	8	2	
40	●	MPS1-0740-L40C	297.3	321.3	323.3	360.3	359	1.3	8	2	
7.5	3	□	MPS1-0750S-DIN	30.1	41.4	42.4	79.4	78	1.4	8	4
	3	●	MPS1-0750S-DIN-C	30.1	41.4	42.4	79.4	78	1.4	8	2
	5	□	MPS1-0750L-DIN	42.1	53.4	54.4	91.4	90	1.4	8	4
	5	●	MPS1-0750L-DIN-C	42.1	53.4	54.4	91.4	90	1.4	8	2
	2	●	MPS1-0750-PC	16.2	35.2	38.2	80.2	79	1.2	8	2
	8	●	MPS1-0750-L8C	61.6	84.6	87.6	124.6	123	1.6	8	2
	10	□	MPS1-0750-L10C	76.4	99.4	102.4	139.4	138	1.4	8	2
	12	●	MPS1-0750-L12C	91.4	114.4	117.4	154.4	153	1.4	8	2
	15	●	MPS1-0750-L15C	113.9	136.4	139.4	176.4	175	1.4	8	2
	20	●	MPS1-0750-L20C	151.4	174.4	177.4	214.4	213	1.4	8	2
	25	●	MPS1-0750-L25C	188.9	211.4	214.4	251.4	250	1.4	8	2
	30	●	MPS1-0750-L30C	226.4	249.4	252.4	289.4	288	1.4	8	2
35	□	MPS1-0750-L35C	263.9	286.4	288.4	325.4	324	1.4	8	2	
40	●	MPS1-0750-L40C	301.4	321.4	323.4	360.4	359	1.4	8	2	
7.6	3	□	MPS1-0760S-DIN	30.0	41.4	42.4	79.4	78	1.4	8	4
	3	●	MPS1-0760S-DIN-C	30.0	41.4	42.4	79.4	78	1.4	8	2
	5	□	MPS1-0760L-DIN	42.0	53.4	54.4	91.4	90	1.4	8	4
	5	●	MPS1-0760L-DIN-C	42.0	53.4	54.4	91.4	90	1.4	8	2
	2	●	MPS1-0760-PC	16.4	38.2	38.2	80.2	79	1.2	8	2
	8	●	MPS1-0760-L8C	62.4	89.6	92.6	129.6	128	1.6	8	2
	10	□	MPS1-0760-L10C	77.4	105.4	108.4	145.4	144	1.4	8	2
	12	●	MPS1-0760-L12C	92.6	121.4	124.4	161.4	160	1.4	8	2
	15	●	MPS1-0760-L15C	115.4	145.4	148.4	185.4	184	1.4	8	2
	20	□	MPS1-0760-L20C	153.4	185.4	188.4	225.4	224	1.4	8	2
	25	●	MPS1-0760-L25C	191.4	225.4	228.4	265.4	264	1.4	8	2
	30	□	MPS1-0760-L30C	229.4	265.4	268.4	305.4	304	1.4	8	2
35	□	MPS1-0760-L35C	267.4	305.4	307.4	344.4	343	1.4	8	2	
40	●	MPS1-0760-L40C	305.4	341.4	342.4	379.4	378	1.4	8	2	

● : Есть на складе. □ : Нет на складе, выпускается исключительно под заказ.

DC (мм)	Глубина сверления (L/D)	DP1021	Обозначение	Размеры (мм)							Тип
				LU	LCF	LH	OAL	LF	PL	DCON	
7.7	3	□	MPS1-0770S-DIN	29.9	41.4	42.4	79.4	78	1.4	8	4
	3	●	MPS1-0770S-DIN-C	29.9	41.4	42.4	79.4	78	1.4	8	2
	5	□	MPS1-0770L-DIN	41.9	53.4	54.4	91.4	90	1.4	8	4
	5	●	MPS1-0770L-DIN-C	41.9	53.4	54.4	91.4	90	1.4	8	2
	2	●	MPS1-0770-PC	16.6	38.2	38.2	80.2	79	1.2	8	2
	8	●	MPS1-0770-L8C	63.2	89.6	92.6	129.6	128	1.6	8	2
	10	□	MPS1-0770-L10C	78.4	105.4	108.4	145.4	144	1.4	8	2
	12	●	MPS1-0770-L12C	93.8	121.4	124.4	161.4	160	1.4	8	2
	15	●	MPS1-0770-L15C	116.9	145.4	148.4	185.4	184	1.4	8	2
	20	□	MPS1-0770-L20C	155.4	185.4	188.4	225.4	224	1.4	8	2
	25	●	MPS1-0770-L25C	193.9	225.4	228.4	265.4	264	1.4	8	2
	30	□	MPS1-0770-L30C	232.4	265.4	268.4	305.4	304	1.4	8	2
35	□	MPS1-0770-L35C	270.9	305.4	307.4	344.4	343	1.4	8	2	
40	●	MPS1-0770-L40C	309.4	341.4	342.4	379.4	378	1.4	8	2	
7.8	3	□	MPS1-0780S-DIN	29.7	41.4	42.4	79.4	78	1.4	8	4
	3	●	MPS1-0780S-DIN-C	29.7	41.4	42.4	79.4	78	1.4	8	2
	5	□	MPS1-0780L-DIN	41.7	53.4	54.4	91.4	90	1.4	8	4
	5	●	MPS1-0780L-DIN-C	41.7	53.4	54.4	91.4	90	1.4	8	2
	2	●	MPS1-0780-PC	16.8	38.2	38.2	80.2	79	1.2	8	2
	8	●	MPS1-0780-L8C	64.0	89.6	92.6	129.6	128	1.6	8	2
	10	□	MPS1-0780-L10C	79.4	105.4	108.4	145.4	144	1.4	8	2
	12	●	MPS1-0780-L12C	95.0	121.4	124.4	161.4	160	1.4	8	2
	15	●	MPS1-0780-L15C	118.4	145.4	148.4	185.4	184	1.4	8	2
	20	□	MPS1-0780-L20C	157.4	185.4	188.4	225.4	224	1.4	8	2
	25	□	MPS1-0780-L25C	196.4	225.4	228.4	265.4	264	1.4	8	2
	30	●	MPS1-0780-L30C	235.4	265.4	268.4	305.4	304	1.4	8	2
35	□	MPS1-0780-L35C	274.4	305.4	307.4	344.4	343	1.4	8	2	
40	●	MPS1-0780-L40C	313.4	341.4	342.4	379.4	378	1.4	8	2	
7.9	3	□	MPS1-0790S-DIN	29.6	41.4	42.4	79.4	78	1.4	8	4
	3	●	MPS1-0790S-DIN-C	29.6	41.4	42.4	79.4	78	1.4	8	2
	5	□	MPS1-0790L-DIN	41.6	53.4	54.4	91.4	90	1.4	8	4
	5	●	MPS1-0790L-DIN-C	41.6	53.4	54.4	91.4	90	1.4	8	2
	2	●	MPS1-0790-PC	17.0	38.2	38.2	80.2	79	1.2	8	2
	8	●	MPS1-0790-L8C	64.8	89.6	92.6	129.6	128	1.6	8	2
	10	□	MPS1-0790-L10C	80.4	105.4	108.4	145.4	144	1.4	8	2
	12	●	MPS1-0790-L12C	96.2	121.4	124.4	161.4	160	1.4	8	2
	15	□	MPS1-0790-L15C	119.9	145.4	148.4	185.4	184	1.4	8	2
	20	□	MPS1-0790-L20C	159.4	185.4	188.4	225.4	224	1.4	8	2
	25	●	MPS1-0790-L25C	198.9	225.4	228.4	265.4	264	1.4	8	2
	30	●	MPS1-0790-L30C	238.4	265.4	268.4	305.4	304	1.4	8	2
35	□	MPS1-0790-L35C	277.9	305.4	307.4	344.4	343	1.4	8	2	
40	●	MPS1-0790-L40C	317.4	341.4	342.4	379.4	378	1.4	8	2	
8.0	3	□	MPS1-0800S-DIN	29.5	41.5	42.5	79.5	78	1.5	8	4
	3	●	MPS1-0800S-DIN-C	29.5	41.5	42.5	79.5	78	1.5	8	2
	5	□	MPS1-0800L-DIN	41.5	53.5	54.5	91.5	90	1.5	8	4
	5	●	MPS1-0800L-DIN-C	41.5	53.5	54.5	91.5	90	1.5	8	2
	2	●	MPS1-0800-PC	17.3	38.3	38.3	80.3	79	1.3	8	2
	8	●	MPS1-0800-L8C	65.7	89.7	92.7	129.7	128	1.7	8	2
	10	●	MPS1-0800-L10C	81.5	105.5	108.5	145.5	144	1.5	8	2
	12	●	MPS1-0800-L12C	97.5	121.5	124.5	161.5	160	1.5	8	2
	15	●	MPS1-0800-L15C	121.5	145.5	148.5	185.5	184	1.5	8	2
	20	●	MPS1-0800-L20C	161.5	185.5	188.5	225.5	224	1.5	8	2
	25	●	MPS1-0800-L25C	201.5	225.5	228.5	265.5	264	1.5	8	2
	30	●	MPS1-0800-L30C	241.5	265.5	268.5	305.5	304	1.5	8	2
35	□	MPS1-0800-L35C	281.5	305.5	307.5	344.5	343	1.5	8	2	
40	●	MPS1-0800-L40C	321.5	341.5	342.5	379.5	378	1.5	8	2	

DC (мм)	Глубина сверления (L/D)	DP1021	Обозначение	Размеры (мм)							Тип
				LU	LCF	LH	OAL	LF	PL	DCON	
8.05	3	□	MPS1-0805S-DIN	34.4	46.5	47.5	88.5	87	1.5	10	4
	3	●	MPS1-0805S-DIN-C	34.4	46.5	47.5	88.5	87	1.5	10	2
	5	□	MPS1-0805L-DIN	48.4	60.5	61.5	102.5	101	1.5	10	4
	5	●	MPS1-0805L-DIN-C	48.4	60.5	61.5	102.5	101	1.5	10	2
	3	□	MPS1-0810S-DIN	34.3	46.5	47.5	88.5	87	1.5	10	4
8.1	3	●	MPS1-0810S-DIN-C	34.3	46.5	47.5	88.5	87	1.5	10	2
	5	□	MPS1-0810L-DIN	48.3	60.5	61.5	102.5	101	1.5	10	4
	5	●	MPS1-0810L-DIN-C	48.3	60.5	61.5	102.5	101	1.5	10	2
	2	●	MPS1-0810-PC	17.5	38.3	41.3	85.3	84	1.3	10	2
	8	●	MPS1-0810-L8C	66.5	95.7	98.7	139.7	138	1.7	10	2
	10	□	MPS1-0810-L10C	82.5	112.5	115.5	156.5	155	1.5	10	2
	12	●	MPS1-0810-L12C	98.7	129.5	132.5	173.5	172	1.5	10	2
	15	●	MPS1-0810-L15C	123.0	154.5	157.5	198.5	197	1.5	10	2
	20	●	MPS1-0810-L20C	163.5	197.5	200.5	241.5	240	1.5	10	2
	25	□	MPS1-0810-L25C	204.0	239.5	242.5	283.5	282	1.5	10	2
	30	□	MPS1-0810-L30C	244.5	282.5	284.5	325.5	324	1.5	10	2
	35	□	MPS1-0810-L35C	285.0	324.5	326.5	367.5	366	1.5	10	2
40	●	MPS1-0810-L40C	325.5	366.5	370.5	411.5	410	1.5	10	2	
8.2	3	□	MPS1-0820S-DIN	34.2	46.5	47.5	88.5	87	1.5	10	4
	3	●	MPS1-0820S-DIN-C	34.2	46.5	47.5	88.5	87	1.5	10	2
	5	□	MPS1-0820L-DIN	48.2	60.5	61.5	102.5	101	1.5	10	4
	5	●	MPS1-0820L-DIN-C	48.2	60.5	61.5	102.5	101	1.5	10	2
	2	●	MPS1-0820-PC	17.7	38.3	41.3	85.3	84	1.3	10	2
	8	●	MPS1-0820-L8C	67.3	95.7	98.7	139.7	138	1.7	10	2
	10	□	MPS1-0820-L10C	83.5	112.5	115.5	156.5	155	1.5	10	2
	12	●	MPS1-0820-L12C	99.9	129.5	132.5	173.5	172	1.5	10	2
	15	●	MPS1-0820-L15C	124.5	154.5	157.5	198.5	197	1.5	10	2
	20	●	MPS1-0820-L20C	165.5	197.5	200.5	241.5	240	1.5	10	2
	25	□	MPS1-0820-L25C	206.5	239.5	242.5	283.5	282	1.5	10	2
	30	□	MPS1-0820-L30C	247.5	282.5	284.5	325.5	324	1.5	10	2
35	□	MPS1-0820-L35C	288.5	324.5	326.5	367.5	366	1.5	10	2	
40	●	MPS1-0820-L40C	329.5	366.5	370.5	411.5	410	1.5	10	2	
8.3	3	□	MPS1-0830S-DIN	34.1	46.5	47.5	88.5	87	1.5	10	4
	3	●	MPS1-0830S-DIN-C	34.1	46.5	47.5	88.5	87	1.5	10	2
	5	□	MPS1-0830L-DIN	48.1	60.5	61.5	102.5	101	1.5	10	4
	5	●	MPS1-0830L-DIN-C	48.1	60.5	61.5	102.5	101	1.5	10	2
	2	●	MPS1-0830-PC	17.9	38.3	41.3	85.3	84	1.3	10	2
	8	●	MPS1-0830-L8C	68.1	95.7	98.7	139.7	138	1.7	10	2
	10	□	MPS1-0830-L10C	84.5	112.5	115.5	156.5	155	1.5	10	2
	12	●	MPS1-0830-L12C	101.1	129.5	132.5	173.5	172	1.5	10	2
	15	□	MPS1-0830-L15C	126.0	154.5	157.5	198.5	197	1.5	10	2
	20	□	MPS1-0830-L20C	167.5	197.5	200.5	241.5	240	1.5	10	2
	25	□	MPS1-0830-L25C	209.0	239.5	242.5	283.5	282	1.5	10	2
	30	□	MPS1-0830-L30C	250.5	282.5	284.5	325.5	324	1.5	10	2
35	□	MPS1-0830-L35C	292.0	324.5	326.5	367.5	366	1.5	10	2	
40	●	MPS1-0830-L40C	333.5	366.5	370.5	411.5	410	1.5	10	2	

ИНСТРУМЕНТ ДЛЯ СВЕРЛЕНИЯ (МОНОЛИТНЫЕ ТВЕРДОСПЛАВНЫЕ СВЕРЛА)

MPS1

Сверхдлинные сверла с четырьмя ленточками

ТВЕРДЫЙ СПЛАВ

ИНСТРУМЕНТ ДЛЯ СВЕРЛЕНИЯ

M

DC (мм)	Глубина сверления (L/D)	DP1021	Обозначение	Размеры (мм)							Тип
				LU	LCF	LH	OAL	LF	PL	DCON	
8.4	3	□	MPS1-0840S-DIN	33.9	46.5	47.5	88.5	87	1.5	10	4
	3	●	MPS1-0840S-DIN-C	33.9	46.5	47.5	88.5	87	1.5	10	2
	5	□	MPS1-0840L-DIN	47.9	60.5	61.5	102.5	101	1.5	10	4
	5	●	MPS1-0840L-DIN-C	47.9	60.5	61.5	102.5	101	1.5	10	2
	2	●	MPS1-0840-PC	18.1	38.3	41.3	85.3	84	1.3	10	2
	8	●	MPS1-0840-L8C	68.9	95.7	98.7	139.7	138	1.7	10	2
	10	□	MPS1-0840-L10C	85.5	112.5	115.5	156.5	155	1.5	10	2
	12	●	MPS1-0840-L12C	102.3	129.5	132.5	173.5	172	1.5	10	2
	15	●	MPS1-0840-L15C	127.5	154.5	157.5	198.5	197	1.5	10	2
	20	□	MPS1-0840-L20C	169.5	197.5	200.5	241.5	240	1.5	10	2
	25	□	MPS1-0840-L25C	211.5	239.5	242.5	283.5	282	1.5	10	2
	30	□	MPS1-0840-L30C	253.5	282.5	284.5	325.5	324	1.5	10	2
35	□	MPS1-0840-L35C	295.5	324.5	326.5	367.5	366	1.5	10	2	
40	●	MPS1-0840-L40C	337.5	366.5	370.5	411.5	410	1.5	10	2	
8.5	3	□	MPS1-0850S-DIN	33.8	46.5	47.5	88.5	87	1.5	10	4
	3	●	MPS1-0850S-DIN-C	33.8	46.5	47.5	88.5	87	1.5	10	2
	5	□	MPS1-0850L-DIN	47.8	60.5	61.5	102.5	101	1.5	10	4
	5	●	MPS1-0850L-DIN-C	47.8	60.5	61.5	102.5	101	1.5	10	2
	2	●	MPS1-0850-PC	18.3	38.3	41.3	85.3	84	1.3	10	2
	8	●	MPS1-0850-L8C	69.8	95.8	98.8	139.8	138	1.8	10	2
	10	□	MPS1-0850-L10C	86.5	112.5	115.5	156.5	155	1.5	10	2
	12	●	MPS1-0850-L12C	103.5	129.5	132.5	173.5	172	1.5	10	2
	15	●	MPS1-0850-L15C	129.0	154.5	157.5	198.5	197	1.5	10	2
	20	●	MPS1-0850-L20C	171.5	197.5	200.5	241.5	240	1.5	10	2
	25	●	MPS1-0850-L25C	214.0	239.5	242.5	283.5	282	1.5	10	2
	30	●	MPS1-0850-L30C	256.5	282.5	284.5	325.5	324	1.5	10	2
35	□	MPS1-0850-L35C	299.0	324.5	326.5	367.5	366	1.5	10	2	
40	●	MPS1-0850-L40C	341.5	366.5	370.5	411.5	410	1.5	10	2	
8.6	3	□	MPS1-0860S-DIN	33.7	46.6	47.6	88.6	87	1.6	10	4
	3	●	MPS1-0860S-DIN-C	33.7	46.6	47.6	88.6	87	1.6	10	2
	5	□	MPS1-0860L-DIN	47.7	60.6	61.6	102.6	101	1.6	10	4
	5	●	MPS1-0860L-DIN-C	47.7	60.6	61.6	102.6	101	1.6	10	2
	2	●	MPS1-0860-PC	18.6	41.4	43.4	85.4	84	1.4	10	2
	8	●	MPS1-0860-L8C	70.6	100.8	103.8	144.8	143	1.8	10	2
	10	□	MPS1-0860-L10C	87.6	118.6	121.6	162.6	161	1.6	10	2
	12	●	MPS1-0860-L12C	104.8	136.6	139.6	180.6	179	1.6	10	2
	15	●	MPS1-0860-L15C	130.6	163.6	166.6	207.6	206	1.6	10	2
	20	□	MPS1-0860-L20C	173.6	208.6	211.6	252.6	251	1.6	10	2
	25	●	MPS1-0860-L25C	216.6	253.6	256.6	297.6	296	1.6	10	2
	30	●	MPS1-0860-L30C	259.6	298.6	300.6	341.6	340	1.6	10	2
35	□	MPS1-0860-L35C	302.6	343.6	345.6	386.6	385	1.6	10	2	
40	●	MPS1-0860-L40C	345.6	391.6	394.6	435.6	434	1.6	10	2	
8.7	3	□	MPS1-0870S-DIN	33.5	46.6	47.6	88.6	87	1.6	10	4
	3	●	MPS1-0870S-DIN-C	33.5	46.6	47.6	88.6	87	1.6	10	2
	5	□	MPS1-0870L-DIN	47.5	60.6	61.6	102.6	101	1.6	10	4
	5	●	MPS1-0870L-DIN-C	47.5	60.6	61.6	102.6	101	1.6	10	2
	2	●	MPS1-0870-PC	18.8	41.4	43.4	85.4	84	1.4	10	2
	8	●	MPS1-0870-L8C	71.4	100.8	103.8	144.8	143	1.8	10	2
	10	□	MPS1-0870-L10C	88.6	118.6	121.6	162.6	161	1.6	10	2
	12	●	MPS1-0870-L12C	106.0	136.6	139.6	180.6	179	1.6	10	2
	15	●	MPS1-0870-L15C	132.1	163.6	166.6	207.6	206	1.6	10	2
	20	□	MPS1-0870-L20C	175.6	208.6	211.6	252.6	251	1.6	10	2
	25	●	MPS1-0870-L25C	219.1	253.6	256.6	297.6	296	1.6	10	2
	30	□	MPS1-0870-L30C	262.6	298.6	300.6	341.6	340	1.6	10	2
35	□	MPS1-0870-L35C	306.1	343.6	345.6	386.6	385	1.6	10	2	
40	●	MPS1-0870-L40C	349.6	391.6	394.6	435.6	434	1.6	10	2	

DC (мм)	Глубина сверления (L/D)	DP1021	Обозначение	Размеры (мм)							Тип
				LU	LCF	LH	OAL	LF	PL	DCON	
8.8	3	□	MPS1-0880S-DIN	33.4	46.6	47.6	88.6	87	1.6	10	4
	3	●	MPS1-0880S-DIN-C	33.4	46.6	47.6	88.6	87	1.6	10	2
	5	□	MPS1-0880L-DIN	47.4	60.6	61.6	102.6	101	1.6	10	4
	5	●	MPS1-0880L-DIN-C	47.4	60.6	61.6	102.6	101	1.6	10	2
	2	●	MPS1-0880-PC	19.0	41.4	43.4	85.4	84	1.4	10	2
	8	●	MPS1-0880-L8C	72.2	100.8	103.8	144.8	143	1.8	10	2
	10	□	MPS1-0880-L10C	89.6	118.6	121.6	162.6	161	1.6	10	2
	12	●	MPS1-0880-L12C	107.2	136.6	139.6	180.6	179	1.6	10	2
	15	●	MPS1-0880-L15C	133.6	163.6	166.6	207.6	206	1.6	10	2
	20	●	MPS1-0880-L20C	177.6	208.6	211.6	252.6	251	1.6	10	2
	25	●	MPS1-0880-L25C	221.6	253.6	256.6	297.6	296	1.6	10	2
	30	●	MPS1-0880-L30C	265.6	298.6	300.6	341.6	340	1.6	10	2
35	□	MPS1-0880-L35C	309.6	343.6	345.6	386.6	385	1.6	10	2	
40	●	MPS1-0880-L40C	353.6	391.6	394.6	435.6	434	1.6	10	2	
8.9	3	□	MPS1-0890S-DIN	33.3	46.6	47.6	88.6	87	1.6	10	4
	3	●	MPS1-0890S-DIN-C	33.3	46.6	47.6	88.6	87	1.6	10	2
	5	□	MPS1-0890L-DIN	47.3	60.6	61.6	102.6	101	1.6	10	4
	5	●	MPS1-0890L-DIN-C	47.3	60.6	61.6	102.6	101	1.6	10	2
	2	●	MPS1-0890-PC	19.2	41.4	43.4	85.4	84	1.4	10	2
	8	●	MPS1-0890-L8C	73.0	100.8	103.8	144.8	143	1.8	10	2
	10	□	MPS1-0890-L10C	90.6	118.6	121.6	162.6	161	1.6	10	2
	12	●	MPS1-0890-L12C	108.4	136.6	139.6	180.6	179	1.6	10	2
	15	□	MPS1-0890-L15C	135.1	163.6	166.6	207.6	206	1.6	10	2
	20	□	MPS1-0890-L20C	179.6	208.6	211.6	252.6	251	1.6	10	2
	25	□	MPS1-0890-L25C	224.1	253.6	256.6	297.6	296	1.6	10	2
	30	□	MPS1-0890-L30C	268.6	298.6	300.6	341.6	340	1.6	10	2
35	□	MPS1-0890-L35C	313.1	343.6	345.6	386.6	385	1.6	10	2	
40	●	MPS1-0890-L40C	357.6	391.6	394.6	435.6	434	1.6	10	2	
9.0	3	□	MPS1-0900S-DIN	33.1	46.6	47.6	88.6	87	1.6	10	4
	3	●	MPS1-0900S-DIN-C	33.1	46.6	47.6	88.6	87	1.6	10	2
	5	□	MPS1-0900L-DIN	47.1	60.6	61.6	102.6	101	1.6	10	4
	5	●	MPS1-0900L-DIN-C	47.1	60.6	61.6	102.6	101	1.6	10	2
	2	●	MPS1-0900-PC	19.4	41.4	43.4	85.4	84	1.4	10	2
	8	●	MPS1-0900-L8C	73.9	100.9	103.9	144.9	143	1.9	10	2
	10	□	MPS1-0900-L10C	91.6	118.6	121.6	162.6	161	1.6	10	2
	12	●	MPS1-0900-L12C	109.6	136.6	139.6	180.6	179	1.6	10	2
	15	●	MPS1-0900-L15C	136.6	163.6	166.6	207.6	206	1.6	10	2
	20	●	MPS1-0900-L20C	181.6	208.6	211.6	252.6	251	1.6	10	2
	25	●	MPS1-0900-L25C	226.6	253.6	256.6	297.6	296	1.6	10	2
	30	●	MPS1-0900-L30C	271.6	298.6	300.6	341.6	340	1.6	10	2
35	□	MPS1-0900-L35C	316.6	343.6	345.6	386.6	385	1.6	10	2	
40	●	MPS1-0900-L40C	361.6	391.6	394.6	435.6	434	1.6	10	2	
9.1	3	□	MPS1-0910S-DIN	33.0	46.7	47.7	88.7	87	1.7	10	4
	3	●	MPS1-0910S-DIN-C	33.0	46.7	47.7	88.7	87	1.7	10	2
	5	□	MPS1-0910L-DIN	47.0	60.7	61.7	102.7	101	1.7	10	4
	5	●	MPS1-0910L-DIN-C	47.0	60.7	61.7	102.7	101	1.7	10	2
	2	●	MPS1-0910-PC	19.6	41.4	44.4	90.4	89	1.4	10	2
	8	●	MPS1-0910-L8C	74.7	106.9	109.9	150.9	149	1.9	10	2
	10	□	MPS1-0910-L10C	92.7	125.7	128.7	169.7	168	1.7	10	2
	12	●	MPS1-0910-L12C	110.9	144.7	147.7	188.7	187	1.7	10	2
	15	●	MPS1-0910-L15C	138.2	172.7	175.7	216.7	215	1.7	10	2
	20	□	MPS1-0910-L20C	183.7	220.7	223.7	264.7	263	1.7	10	2
	25	□	MPS1-0910-L25C	229.2	267.7	270.7	311.7	310	1.7	10	2
	30	●	MPS1-0910-L30C	274.7	315.7	318.7	359.7	358	1.7	10	2
35	□	MPS1-0910-L35C	320.2	362.7	364.7	405.7	404	1.7	10	2	

● : Есть на складе. □ : Нет на складе, выпускается исключительно под заказ.

DC (мм)	Глубина сверления (L/D)	DP1021	Обозначение	Размеры (мм)							Тип
				LU	LCF	LH	OAL	LF	PL	DCON	
9.2	3	□	MPS1-0920S-DIN	32.9	46.7	47.7	88.7	87	1.7	10	4
	3	●	MPS1-0920S-DIN-C	32.9	46.7	47.7	88.7	87	1.7	10	2
	5	□	MPS1-0920L-DIN	46.9	60.7	61.7	102.7	101	1.7	10	4
	5	●	MPS1-0920L-DIN-C	46.9	60.7	61.7	102.7	101	1.7	10	2
	2	●	MPS1-0920-PC	19.9	41.5	44.5	90.5	89	1.5	10	2
	8	●	MPS1-0920-L8C	75.5	106.9	109.9	150.9	149	1.9	10	2
	10	□	MPS1-0920-L10C	93.7	125.7	128.7	169.7	168	1.7	10	2
	12	●	MPS1-0920-L12C	112.1	144.7	147.7	188.7	187	1.7	10	2
	15	●	MPS1-0920-L15C	139.7	172.7	175.7	216.7	215	1.7	10	2
	20	□	MPS1-0920-L20C	185.7	220.7	223.7	264.7	263	1.7	10	2
	25	□	MPS1-0920-L25C	231.7	267.7	270.7	311.7	310	1.7	10	2
	30	□	MPS1-0920-L30C	277.7	315.7	318.7	359.7	358	1.7	10	2
35	□	MPS1-0920-L35C	323.7	362.7	364.7	405.7	404	1.7	10	2	
9.3	3	□	MPS1-0930S-DIN	32.7	46.7	47.7	88.7	87	1.7	10	4
	3	●	MPS1-0930S-DIN-C	32.7	46.7	47.7	88.7	87	1.7	10	2
	5	□	MPS1-0930L-DIN	46.7	60.7	61.7	102.7	101	1.7	10	4
	5	●	MPS1-0930L-DIN-C	46.7	60.7	61.7	102.7	101	1.7	10	2
	2	●	MPS1-0930-PC	20.1	41.5	44.5	90.5	89	1.5	10	2
	8	●	MPS1-0930-L8C	76.3	106.9	109.9	150.9	149	1.9	10	2
	10	□	MPS1-0930-L10C	94.7	125.7	128.7	169.7	168	1.7	10	2
	12	●	MPS1-0930-L12C	113.3	144.7	147.7	188.7	187	1.7	10	2
	15	□	MPS1-0930-L15C	141.2	172.7	175.7	216.7	215	1.7	10	2
	20	□	MPS1-0930-L20C	187.7	220.7	223.7	264.7	263	1.7	10	2
	25	□	MPS1-0930-L25C	234.2	267.7	270.7	311.7	310	1.7	10	2
	30	□	MPS1-0930-L30C	280.7	315.7	318.7	359.7	358	1.7	10	2
35	□	MPS1-0930-L35C	327.2	362.7	364.7	405.7	404	1.7	10	2	
9.4	3	□	MPS1-0940S-DIN	32.6	46.7	47.7	88.7	87	1.7	10	4
	3	●	MPS1-0940S-DIN-C	32.6	46.7	47.7	88.7	87	1.7	10	2
	5	□	MPS1-0940L-DIN	46.6	60.7	61.7	102.7	101	1.7	10	4
	5	●	MPS1-0940L-DIN-C	46.6	60.7	61.7	102.7	101	1.7	10	2
	2	●	MPS1-0940-PC	20.3	41.5	44.5	90.5	89	1.5	10	2
	8	●	MPS1-0940-L8C	77.1	106.9	109.9	150.9	149	1.9	10	2
	10	□	MPS1-0940-L10C	95.7	125.7	128.7	169.7	168	1.7	10	2
	12	●	MPS1-0940-L12C	114.5	144.7	147.7	188.7	187	1.7	10	2
	15	□	MPS1-0940-L15C	142.7	172.7	175.7	216.7	215	1.7	10	2
	20	□	MPS1-0940-L20C	189.7	220.7	223.7	264.7	263	1.7	10	2
	25	□	MPS1-0940-L25C	236.7	267.7	270.7	311.7	310	1.7	10	2
	30	□	MPS1-0940-L30C	283.7	315.7	318.7	359.7	358	1.7	10	2
35	□	MPS1-0940-L35C	330.7	362.7	364.7	405.7	404	1.7	10	2	
9.5	3	□	MPS1-0950S-DIN	32.5	46.7	47.7	88.7	87	1.7	10	4
	3	●	MPS1-0950S-DIN-C	32.5	46.7	47.7	88.7	87	1.7	10	2
	5	□	MPS1-0950L-DIN	46.5	60.7	61.7	102.7	101	1.7	10	4
	5	●	MPS1-0950L-DIN-C	46.5	60.7	61.7	102.7	101	1.7	10	2
	2	●	MPS1-0950-PC	20.5	41.5	44.5	90.5	89	1.5	10	2
	8	●	MPS1-0950-L8C	78.0	107.0	110.0	151.0	149	2.0	10	2
	10	□	MPS1-0950-L10C	96.7	125.7	128.7	169.7	168	1.7	10	2
	12	●	MPS1-0950-L12C	115.7	144.7	147.7	188.7	187	1.7	10	2
	15	●	MPS1-0950-L15C	144.2	172.7	175.7	216.7	215	1.7	10	2
	20	●	MPS1-0950-L20C	191.7	220.7	223.7	264.7	263	1.7	10	2
	25	●	MPS1-0950-L25C	239.2	267.7	270.7	311.7	310	1.7	10	2
	30	●	MPS1-0950-L30C	286.7	315.7	318.7	359.7	358	1.7	10	2
35	□	MPS1-0950-L35C	334.2	362.7	364.7	405.7	404	1.7	10	2	

DC (мм)	Глубина сверления (L/D)	DP1021	Обозначение	Размеры (мм)							Тип
				LU	LCF	LH	OAL	LF	PL	DCON	
9.6	3	□	MPS1-0960S-DIN	32.3	46.7	47.7	88.7	87	1.7	10	4
	3	●	MPS1-0960S-DIN-C	32.3	46.7	47.7	88.7	87	1.7	10	2
	5	□	MPS1-0960L-DIN	46.3	60.7	61.7	102.7	101	1.7	10	4
	5	●	MPS1-0960L-DIN-C	46.3	60.7	61.7	102.7	101	1.7	10	2
	2	●	MPS1-0960-PC	20.7	44.5	44.5	90.5	89	1.5	10	2
	8	●	MPS1-0960-L8C	78.8	112.0	115.0	156.0	154	2.0	10	2
	10	□	MPS1-0960-L10C	97.7	131.7	134.7	175.7	174	1.7	10	2
	12	●	MPS1-0960-L12C	116.9	151.7	154.7	195.7	194	1.7	10	2
	15	●	MPS1-0960-L15C	145.7	181.7	184.7	225.7	224	1.7	10	2
	20	□	MPS1-0960-L20C	193.7	231.7	234.7	275.7	274	1.7	10	2
	25	□	MPS1-0960-L25C	241.7	281.7	284.7	325.7	324	1.7	10	2
	30	□	MPS1-0960-L30C	289.7	331.7	334.7	375.7	374	1.7	10	2
35	□	MPS1-0960-L35C	337.7	381.7	383.7	424.7	423	1.7	10	2	
9.7	3	□	MPS1-0970S-DIN	32.2	46.8	47.8	88.8	87	1.8	10	4
	3	●	MPS1-0970S-DIN-C	32.2	46.8	47.8	88.8	87	1.8	10	2
	5	□	MPS1-0970L-DIN	46.2	60.8	61.8	102.8	101	1.8	10	4
	5	●	MPS1-0970L-DIN-C	46.2	60.8	61.8	102.8	101	1.8	10	2
	2	●	MPS1-0970-PC	20.9	44.5	44.5	90.5	89	1.5	10	2
	8	●	MPS1-0970-L8C	79.6	112.0	115.0	156.0	154	2.0	10	2
	10	□	MPS1-0970-L10C	98.8	131.8	134.8	175.8	174	1.8	10	2
	12	●	MPS1-0970-L12C	118.2	151.8	154.8	195.8	194	1.8	10	2
	15	●	MPS1-0970-L15C	147.3	181.8	184.8	225.8	224	1.8	10	2
	20	□	MPS1-0970-L20C	195.8	231.8	234.8	275.8	274	1.8	10	2
	25	□	MPS1-0970-L25C	244.3	281.8	284.8	325.8	324	1.8	10	2
	30	□	MPS1-0970-L30C	292.8	331.8	334.8	375.8	374	1.8	10	2
35	□	MPS1-0970-L35C	341.3	381.8	383.8	424.8	423	1.8	10	2	
9.8	3	□	MPS1-0980S-DIN	32.1	46.8	47.8	88.8	87	1.8	10	4
	3	●	MPS1-0980S-DIN-C	32.1	46.8	47.8	88.8	87	1.8	10	2
	5	□	MPS1-0980L-DIN	46.1	60.8	61.8	102.8	101	1.8	10	4
	5	●	MPS1-0980L-DIN-C	46.1	60.8	61.8	102.8	101	1.8	10	2
	2	●	MPS1-0980-PC	21.1	44.5	44.5	90.5	89	1.5	10	2
	8	●	MPS1-0980-L8C	80.4	112.0	115.0	156.0	154	2.0	10	2
	10	□	MPS1-0980-L10C	99.8	131.8	134.8	175.8	174	1.8	10	2
	12	●	MPS1-0980-L12C	119.4	151.8	154.8	195.8	194	1.8	10	2
	15	●	MPS1-0980-L15C	148.8	181.8	184.8	225.8	224	1.8	10	2
	20	●	MPS1-0980-L20C	197.8	231.8	234.8	275.8	274	1.8	10	2
	25	□	MPS1-0980-L25C	246.8	281.8	284.8	325.8	324	1.8	10	2
	30	●	MPS1-0980-L30C	295.8	331.8	334.8	375.8	374	1.8	10	2
35	□	MPS1-0980-L35C	344.8	381.8	383.8	424.8	423	1.8	10	2	
9.9	3	□	MPS1-0990S-DIN	32.0	46.8	47.8	88.8	87	1.8	10	4
	3	●	MPS1-0990S-DIN-C	32.0	46.8	47.8	88.8	87	1.8	10	2
	5	□	MPS1-0990L-DIN	46.0	60.8	61.8	102.8	101	1.8	10	4
	5	●	MPS1-0990L-DIN-C	46.0	60.8	61.8	102.8	101	1.8	10	2
	2	●	MPS1-0990-PC	21.4	44.6	44.6	90.6	89	1.6	10	2
	8	●	MPS1-0990-L8C	81.3	112.1	115.1	156.1	154	2.1	10	2
	10	□	MPS1-0990-L10C	100.8	131.8	134.8	175.8	174	1.8	10	2
	12	●	MPS1-0990-L12C	120.6	151.8	154.8	195.8	194	1.8	10	2
	15	●	MPS1-0990-L15C	150.3	181.8	184.8	225.8	224	1.8	10	2
	20	□	MPS1-0990-L20C	199.8	231.8	234.8	275.8	274	1.8	10	2
	25	□	MPS1-0990-L25C	249.3	281.8	284.8	325.8	324	1.8	10	2
	30	□	MPS1-0990-L30C	298.8	331.8	334.8	375.8	374	1.8	10	2
35	□	MPS1-0990-L35C	348.3	381.8	383.8	424.8	423	1.8	10	2	

М
ИНСТРУМЕНТ ДЛЯ
СВЕРЛЕНИЯ

ИНСТРУМЕНТ ДЛЯ СВЕРЛЕНИЯ (МОНОЛИТНЫЕ ТВЕРДОСПЛАВНЫЕ СВЕРЛА)

MPS1

Сверхдлинные сверла с четырьмя ленточками

ТВЕРДЫЙ
СПЛАВ

ИНСТРУМЕНТ ДЛЯ
СВЕРЛЕНИЯ

M

DC (мм)	Глубина сверления (L/D)	DP1021	Обозначение	Размеры (мм)							Тип	
				LU	LCF	LH	OAL	LF	PL	DCON		
10.0	3	□	MPS1-1000S-DIN	31.8	46.8	47.8	88.8	87	1.8	10	4	
	3	●	MPS1-1000S-DIN-C	31.8	46.8	47.8	88.8	87	1.8	10	2	
	5	□	MPS1-1000L-DIN	45.8	60.8	61.8	102.8	101	1.8	10	4	
	5	●	MPS1-1000L-DIN-C	45.8	60.8	61.8	102.8	101	1.8	10	2	
	2	●	MPS1-1000-PC	21.6	44.6	44.6	90.6	89	1.6	10	2	
	8	●	MPS1-1000-L8C	82.1	112.1	115.1	156.1	154	2.1	10	2	
	10	●	MPS1-1000-L10C	101.8	131.8	134.8	175.8	174	1.8	10	2	
	12	●	MPS1-1000-L12C	121.8	151.8	154.8	195.8	194	1.8	10	2	
	15	●	MPS1-1000-L15C	151.8	181.8	184.8	225.8	224	1.8	10	2	
	20	●	MPS1-1000-L20C	201.8	231.8	234.8	275.8	274	1.8	10	2	
10.05	25	●	MPS1-1000-L25C	251.8	281.8	284.8	325.8	324	1.8	10	2	
	30	●	MPS1-1000-L30C	301.8	331.8	334.8	375.8	374	1.8	10	2	
	35	□	MPS1-1000-L35C	351.8	381.8	383.8	424.8	423	1.8	10	2	
	3	□	MPS1-1005S-DIN	39.8	54.8	55.8	101.8	100	1.8	12	4	
	3	●	MPS1-1005S-DIN-C	39.8	54.8	55.8	101.8	100	1.8	12	2	
	5	□	MPS1-1005L-DIN	55.8	70.8	71.8	117.8	116	1.8	12	4	
	5	●	MPS1-1005L-DIN-C	55.8	70.8	71.8	117.8	116	1.8	12	2	
	10.1	3	□	MPS1-1010S-DIN	39.7	54.8	55.8	101.8	100	1.8	12	4
		3	●	MPS1-1010S-DIN-C	39.7	54.8	55.8	101.8	100	1.8	12	2
		5	□	MPS1-1010L-DIN	55.7	70.8	71.8	117.8	116	1.8	12	4
5		●	MPS1-1010L-DIN-C	55.7	70.8	71.8	117.8	116	1.8	12	2	
2		●	MPS1-1010-PC	21.8	44.6	47.6	96.6	95	1.6	12	2	
8		●	MPS1-1010-L8C	82.9	118.1	121.1	167.1	165	2.1	12	2	
10		□	MPS1-1010-L10C	102.8	138.8	141.8	187.8	186	1.8	12	2	
12		●	MPS1-1010-L12C	123.0	159.8	162.8	208.8	207	1.8	12	2	
15		●	MPS1-1010-L15C	153.3	190.8	193.8	239.8	238	1.8	12	2	
20		●	MPS1-1010-L20C	203.8	243.8	246.8	292.8	291	1.8	12	2	
10.2	25	□	MPS1-1010-L25C	254.3	295.8	298.8	344.8	343	1.8	12	2	
	3	□	MPS1-1020S-DIN	39.6	54.9	55.9	101.9	100	1.9	12	4	
	3	●	MPS1-1020S-DIN-C	39.6	54.9	55.9	101.9	100	1.9	12	2	
	5	□	MPS1-1020L-DIN	55.6	70.9	71.9	117.9	116	1.9	12	4	
	5	●	MPS1-1020L-DIN-C	55.6	70.9	71.9	117.9	116	1.9	12	2	
	2	●	MPS1-1020-PC	22.0	44.6	47.6	96.6	95	1.6	12	2	
	8	●	MPS1-1020-L8C	83.7	118.1	121.1	167.1	165	2.1	12	2	
	10	□	MPS1-1020-L10C	103.9	138.9	141.9	187.9	186	1.9	12	2	
	12	●	MPS1-1020-L12C	124.3	159.9	162.9	208.9	207	1.9	12	2	
	15	●	MPS1-1020-L15C	154.9	190.9	193.9	239.9	238	1.9	12	2	
10.3	20	●	MPS1-1020-L20C	205.9	243.9	246.9	292.9	291	1.9	12	2	
	25	□	MPS1-1020-L25C	256.9	295.9	298.9	344.9	343	1.9	12	2	
	3	□	MPS1-1030S-DIN	39.4	54.9	55.9	101.9	100	1.9	12	4	
	3	●	MPS1-1030S-DIN-C	39.4	54.9	55.9	101.9	100	1.9	12	2	
	5	□	MPS1-1030L-DIN	55.4	70.9	71.9	117.9	116	1.9	12	4	
	5	●	MPS1-1030L-DIN-C	55.4	70.9	71.9	117.9	116	1.9	12	2	
	2	●	MPS1-1030-PC	22.2	44.6	47.6	96.6	95	1.6	12	2	
	8	●	MPS1-1030-L8C	84.5	118.1	121.1	167.1	165	2.1	12	2	
	10	□	MPS1-1030-L10C	104.9	138.9	141.9	187.9	186	1.9	12	2	
	12	●	MPS1-1030-L12C	125.5	159.9	162.9	208.9	207	1.9	12	2	
10.4	15	□	MPS1-1030-L15C	156.4	190.9	193.9	239.9	238	1.9	12	2	
	20	□	MPS1-1030-L20C	207.9	243.9	246.9	292.9	291	1.9	12	2	
	25	□	MPS1-1030-L25C	259.4	295.9	298.9	344.9	343	1.9	12	2	
	3	□	MPS1-1040S-DIN	39.3	54.9	55.9	101.9	100	1.9	12	4	
	3	●	MPS1-1040S-DIN-C	39.3	54.9	55.9	101.9	100	1.9	12	2	
	5	□	MPS1-1040L-DIN	55.3	70.9	71.9	117.9	116	1.9	12	4	
	5	●	MPS1-1040L-DIN-C	55.3	70.9	71.9	117.9	116	1.9	12	2	
	2	●	MPS1-1040-PC	22.4	44.6	47.6	96.6	95	1.6	12	2	
	8	●	MPS1-1040-L8C	85.4	118.2	121.2	167.2	165	2.2	12	2	
	10	□	MPS1-1040-L10C	105.9	138.9	141.9	187.9	186	1.9	12	2	
10.5	12	●	MPS1-1040-L12C	126.7	159.9	162.9	208.9	207	1.9	12	2	
	15	□	MPS1-1040-L15C	157.9	190.9	193.9	239.9	238	1.9	12	2	
	20	□	MPS1-1040-L20C	209.9	243.9	246.9	292.9	291	1.9	12	2	
	25	□	MPS1-1040-L25C	261.9	295.9	298.9	344.9	343	1.9	12	2	
	3	□	MPS1-1050S-DIN	39.2	54.9	55.9	101.9	100	1.9	12	4	
	3	●	MPS1-1050S-DIN-C	39.2	54.9	55.9	101.9	100	1.9	12	2	
	5	□	MPS1-1050L-DIN	55.2	70.9	71.9	117.9	116	1.9	12	4	
	5	●	MPS1-1050L-DIN-C	55.2	70.9	71.9	117.9	116	1.9	12	2	
	2	●	MPS1-1050-PC	22.7	44.7	47.7	96.7	95	1.7	12	2	
	8	●	MPS1-1050-L8C	86.2	118.2	121.2	167.2	165	2.2	12	2	
10.6	10	□	MPS1-1050-L10C	106.9	138.9	141.9	187.9	186	1.9	12	2	
	12	●	MPS1-1050-L12C	127.9	159.9	162.9	208.9	207	1.9	12	2	
	15	●	MPS1-1050-L15C	159.4	190.9	193.9	239.9	238	1.9	12	2	
	20	●	MPS1-1050-L20C	211.9	243.9	246.9	292.9	291	1.9	12	2	
	25	●	MPS1-1050-L25C	264.4	295.9	298.9	344.9	343	1.9	12	2	
	3	□	MPS1-1060S-DIN	39.0	54.9	55.9	101.9	100	1.9	12	4	
	3	●	MPS1-1060S-DIN-C	39.0	54.9	55.9	101.9	100	1.9	12	2	
	5	□	MPS1-1060L-DIN	55.0	70.9	71.9	117.9	116	1.9	12	4	
	5	●	MPS1-1060L-DIN-C	55.0	70.9	71.9	117.9	116	1.9	12	2	
	2	□	MPS1-1060-PC	22.9	48.7	49.7	96.7	95	1.7	12	2	
10.7	8	●	MPS1-1060-L8C	87.0	123.2	126.2	172.2	170	2.2	12	2	
	10	□	MPS1-1060-L10C	107.9	144.9	147.9	193.9	192	1.9	12	2	
	12	□	MPS1-1060-L12C	129.1	166.9	169.9	215.9	214	1.9	12	2	
	15	□	MPS1-1060-L15C	160.9	199.9	202.9	248.9	247	1.9	12	2	
	20	□	MPS1-1060-L20C	213.9	254.9	257.9	303.9	302	1.9	12	2	
	25	□	MPS1-1060-L25C	266.9	309.9	312.9	358.9	357	1.9	12	2	
	3	□	MPS1-1070S-DIN	38.9	54.9	55.9	101.9	100	1.9	12	4	
	3	●	MPS1-1070S-DIN-C	38.9	54.9	55.9	101.9	100	1.9	12	2	
	5	□	MPS1-1070L-DIN	54.9	70.9	71.9	117.9	116	1.9	12	4	
	5	●	MPS1-1070L-DIN-C	54.9	70.9	71.9	117.9	116	1.9	12	2	
2	●	MPS1-1070-PC	23.1	48.7	49.7	96.7	95	1.7	12	2		
10.8	8	●	MPS1-1070-L8C	87.8	123.2	126.2	172.2	170	2.2	12	2	
	10	□	MPS1-1070-L10C	108.9	144.9	147.9	193.9	192	1.9	12	2	
	12	●	MPS1-1070-L12C	130.3	166.9	169.9	215.9	214	1.9	12	2	
	15	□	MPS1-1070-L15C	162.4	199.9	202.9	248.9	247	1.9	12	2	
	20	□	MPS1-1070-L20C	215.9	254.9	257.9	303.9	302	1.9	12	2	
	25	□	MPS1-1070-L25C	269.4	309.9	312.9	358.9	357	1.9	12	2	
	3	□	MPS1-1080S-DIN	38.8	55.0	56.0	102.0	100	2.0	12	4	
	3	●	MPS1-1080S-DIN-C	38.8	55.0	56.0	102.0	100	2.0	12	2	
	5	□	MPS1-1080L-DIN	54.8	71.0	72.0	118.0	116	2.0	12	4	
	5	●	MPS1-1080L-DIN-C	54.8	71.0	72.0	118.0	116	2.0	12	2	
2	●	MPS1-1080-PC	23.3	48.7	49.7	96.7	95	1.7	12	2		
10.8	8	●	MPS1-1080-L8C	88.6	123.2	126.2	172.2	170	2.2	12	2	
	10	□	MPS1-1080-L10C	110.0	145.0	148.0	194.0	192	2.0	12	2	
	12	●	MPS1-1080-L12C	131.6	167.0	170.0	216.0	214	2.0	12	2	
	15	□	MPS1-1080-L15C	164.0	200.0	203.0	249.0	247	2.0	12	2	
	20	□	MPS1-1080-L20C	218.0	255.0	258.0	304.0	302	2.0	12	2	
	25	□	MPS1-1080-L25C	272.0	310.0	313.0	359.0	357	2.0	12	2	

DC (мм)	Глубина сверления (L/D)	DP1021	Обозначение	Размеры (мм)							Тип
				LU	LCF	LH	OAL	LF	PL	DCON	
10.4	3	□	MPS1-1040S-DIN	39.3	54.9	55.9	101.9	100	1.9	12	4
	3	●	MPS1-1040S-DIN-C	39.3	54.9	55.9	101.9	100	1.9	12	2
	5	□	MPS1-1040L-DIN	55.3	70.9	71.9	117.9	116	1.9	12	4
	5	●	MPS1-1040L-DIN-C	55.3	70.9	71.9	117.9	116	1.9	12	2
	2	●	MPS1-1040-PC	22.4	44.6	47.6	96.6	95	1.6	12	2
	8	●	MPS1-1040-L8C	85.4	118.2	121.2	167.2	165	2.2	12	2
	10	□	MPS1-1040-L10C	105.9	138.9	141.9	187.9	186	1.9	12	2
	12	●	MPS1-1040-L12C	126.7	159.9	162.9	208.9	207	1.9	12	2
	15	□	MPS1-1040-L15C	157.9	190.9	193.9	239.9	238	1.9	12	2
	20	□	MPS1-1040-L20C	209.9	243.9	246.9	292.9	291	1.9	12	2
10.5	25										

DC (мм)	Глубина сверления (L/D)	DP1021	Обозначение	Размеры (мм)							Тип
				LU	LCF	LH	OAL	LF	PL	DCON	
10.9	3	□	MPS1-1090S-DIN	38.6	55.0	56.0	102.0	100	2.0	12	4
	3	●	MPS1-1090S-DIN-C	38.6	55.0	56.0	102.0	100	2.0	12	2
	5	□	MPS1-1090L-DIN	54.6	71.0	72.0	118.0	116	2.0	12	4
	5	●	MPS1-1090L-DIN-C	54.6	71.0	72.0	118.0	116	2.0	12	2
	2	□	MPS1-1090-PC	23.5	48.7	49.7	96.7	95	1.7	12	2
	8	●	MPS1-1090-L8C	89.5	123.3	126.3	172.3	170	2.3	12	2
	10	□	MPS1-1090-L10C	111.0	145.0	148.0	194.0	192	2.0	12	2
	12	□	MPS1-1090-L12C	132.8	167.0	170.0	216.0	214	2.0	12	2
	15	□	MPS1-1090-L15C	165.5	200.0	203.0	249.0	247	2.0	12	2
	20	□	MPS1-1090-L20C	220.0	255.0	258.0	304.0	302	2.0	12	2
25	□	MPS1-1090-L25C	274.5	310.0	313.0	359.0	357	2.0	12	2	
11.0	3	□	MPS1-1100S-DIN	38.5	55.0	56.0	102.0	100	2.0	12	4
	3	●	MPS1-1100S-DIN-C	38.5	55.0	56.0	102.0	100	2.0	12	2
	5	□	MPS1-1100L-DIN	54.5	71.0	72.0	118.0	116	2.0	12	4
	5	●	MPS1-1100L-DIN-C	54.5	71.0	72.0	118.0	116	2.0	12	2
	2	●	MPS1-1100-PC	23.7	48.7	49.7	96.7	95	1.7	12	2
	8	●	MPS1-1100-L8C	90.3	123.3	126.3	172.3	170	2.3	12	2
	10	□	MPS1-1100-L10C	112.0	145.0	148.0	194.0	192	2.0	12	2
	12	●	MPS1-1100-L12C	134.0	167.0	170.0	216.0	214	2.0	12	2
	15	●	MPS1-1100-L15C	167.0	200.0	203.0	249.0	247	2.0	12	2
	20	●	MPS1-1100-L20C	222.0	255.0	258.0	304.0	302	2.0	12	2
25	●	MPS1-1100-L25C	277.0	310.0	313.0	359.0	357	2.0	12	2	
11.1	3	□	MPS1-1110S-DIN	38.4	55.0	56.0	102.0	100	2.0	12	4
	3	●	MPS1-1110S-DIN-C	38.4	55.0	56.0	102.0	100	2.0	12	2
	5	□	MPS1-1110L-DIN	54.4	71.0	72.0	118.0	116	2.0	12	4
	5	●	MPS1-1110L-DIN-C	54.4	71.0	72.0	118.0	116	2.0	12	2
	2	●	MPS1-1110-PC	23.9	48.7	51.7	96.7	95	1.7	12	2
	8	●	MPS1-1110-L8C	91.1	129.3	132.3	178.3	176	2.3	12	2
	10	□	MPS1-1110-L10C	113.0	152.0	155.0	201.0	199	2.0	12	2
	12	●	MPS1-1110-L12C	135.2	175.0	178.0	224.0	222	2.0	12	2
	15	●	MPS1-1110-L15C	168.5	209.0	212.0	258.0	256	2.0	12	2
	20	□	MPS1-1110-L20C	224.0	267.0	270.0	316.0	314	2.0	12	2
25	●	MPS1-1110-L25C	279.5	324.0	327.0	373.0	371	2.0	12	2	
11.2	3	□	MPS1-1120S-DIN	38.2	55.0	56.0	102.0	100	2.0	12	4
	3	●	MPS1-1120S-DIN-C	38.2	55.0	56.0	102.0	100	2.0	12	2
	5	□	MPS1-1120L-DIN	54.2	71.0	72.0	118.0	116	2.0	12	4
	5	●	MPS1-1120L-DIN-C	54.2	71.0	72.0	118.0	116	2.0	12	2
	2	●	MPS1-1120-PC	24.2	48.8	51.8	96.8	95	1.8	12	2
	8	●	MPS1-1120-L8C	91.9	129.3	132.3	178.3	176	2.3	12	2
	10	□	MPS1-1120-L10C	114.0	152.0	155.0	201.0	199	2.0	12	2
	12	□	MPS1-1120-L12C	136.4	175.0	178.0	224.0	222	2.0	12	2
	15	●	MPS1-1120-L15C	170.0	209.0	212.0	258.0	256	2.0	12	2
	20	□	MPS1-1120-L20C	226.0	267.0	270.0	316.0	314	2.0	12	2
25	□	MPS1-1120-L25C	282.0	324.0	327.0	373.0	371	2.0	12	2	
11.3	3	□	MPS1-1130S-DIN	38.1	55.1	56.1	102.1	100	2.1	12	4
	3	●	MPS1-1130S-DIN-C	38.1	55.1	56.1	102.1	100	2.1	12	2
	5	□	MPS1-1130L-DIN	54.1	71.1	72.1	118.1	116	2.1	12	4
	5	●	MPS1-1130L-DIN-C	54.1	71.1	72.1	118.1	116	2.1	12	2
	2	□	MPS1-1130-PC	24.4	48.8	51.8	96.8	95	1.8	12	2
	8	●	MPS1-1130-L8C	92.7	129.3	132.3	178.3	176	2.3	12	2
	10	□	MPS1-1130-L10C	115.1	152.1	155.1	201.1	199	2.1	12	2
	12	□	MPS1-1130-L12C	137.7	175.1	178.1	224.1	222	2.1	12	2
	15	□	MPS1-1130-L15C	171.6	209.1	212.1	258.1	256	2.1	12	2
	20	□	MPS1-1130-L20C	228.1	267.1	270.1	316.1	314	2.1	12	2
25	□	MPS1-1130-L25C	284.6	324.1	327.1	373.1	371	2.1	12	2	

DC (мм)	Глубина сверления (L/D)	DP1021	Обозначение	Размеры (мм)							Тип
				LU	LCF	LH	OAL	LF	PL	DCON	
11.4	3	□	MPS1-1140S-DIN	38.0	55.1	56.1	102.1	100	2.1	12	4
	3	●	MPS1-1140S-DIN-C	38.0	55.1	56.1	102.1	100	2.1	12	2
	5	□	MPS1-1140L-DIN	54.0	71.1	72.1	118.1	116	2.1	12	4
	5	●	MPS1-1140L-DIN-C	54.0	71.1	72.1	118.1	116	2.1	12	2
	2	□	MPS1-1140-PC	24.6	48.8	51.8	96.8	95	1.8	12	2
	8	●	MPS1-1140-L8C	93.6	129.4	132.4	178.4	176	2.4	12	2
	10	□	MPS1-1140-L10C	116.1	152.1	155.1	201.1	199	2.1	12	2
	12	□	MPS1-1140-L12C	138.9	175.1	178.1	224.1	222	2.1	12	2
	15	□	MPS1-1140-L15C	173.1	209.1	212.1	258.1	256	2.1	12	2
	20	□	MPS1-1140-L20C	230.1	267.1	270.1	316.1	314	2.1	12	2
25	□	MPS1-1140-L25C	287.1	324.1	327.1	373.1	371	2.1	12	2	
11.5	3	□	MPS1-1150S-DIN	37.8	55.1	56.1	102.1	100	2.1	12	4
	3	●	MPS1-1150S-DIN-C	37.8	55.1	56.1	102.1	100	2.1	12	2
	5	□	MPS1-1150L-DIN	53.8	71.1	72.1	118.1	116	2.1	12	4
	5	●	MPS1-1150L-DIN-C	53.8	71.1	72.1	118.1	116	2.1	12	2
	2	●	MPS1-1150-PC	24.8	48.8	51.8	96.8	95	1.8	12	2
	8	●	MPS1-1150-L8C	94.4	129.4	132.4	178.4	176	2.4	12	2
	10	□	MPS1-1150-L10C	117.1	152.1	155.1	201.1	199	2.1	12	2
	12	●	MPS1-1150-L12C	140.1	175.1	178.1	224.1	222	2.1	12	2
	15	●	MPS1-1150-L15C	174.6	209.1	212.1	258.1	256	2.1	12	2
	20	●	MPS1-1150-L20C	232.1	267.1	270.1	316.1	314	2.1	12	2
25	●	MPS1-1150-L25C	289.6	324.1	327.1	373.1	371	2.1	12	2	
11.6	3	□	MPS1-1160S-DIN	37.7	55.1	56.1	102.1	100	2.1	12	4
	3	●	MPS1-1160S-DIN-C	37.7	55.1	56.1	102.1	100	2.1	12	2
	5	□	MPS1-1160L-DIN	53.7	71.1	72.1	118.1	116	2.1	12	4
	5	●	MPS1-1160L-DIN-C	53.7	71.1	72.1	118.1	116	2.1	12	2
	2	□	MPS1-1160-PC	25.0	48.8	48.8	96.8	95	1.8	12	2
	8	●	MPS1-1160-L8C	95.2	134.4	137.4	183.4	181	2.4	12	2
	10	□	MPS1-1160-L10C	118.1	158.1	161.1	207.1	205	2.1	12	2
	12	□	MPS1-1160-L12C	141.3	182.1	185.1	231.1	229	2.1	12	2
	15	□	MPS1-1160-L15C	176.1	218.1	221.1	267.1	265	2.1	12	2
	20	□	MPS1-1160-L20C	234.1	278.1	281.1	327.1	325	2.1	12	2
25	□	MPS1-1160-L25C	292.1	338.1	341.1	387.1	385	2.1	12	2	
11.7	3	□	MPS1-1170S-DIN	37.6	55.1	56.1	102.1	100	2.1	12	4
	3	●	MPS1-1170S-DIN-C	37.6	55.1	56.1	102.1	100	2.1	12	2
	5	□	MPS1-1170L-DIN	53.6	71.1	72.1	118.1	116	2.1	12	4
	5	●	MPS1-1170L-DIN-C	53.6	71.1	72.1	118.1	116	2.1	12	2
	2	●	MPS1-1170-PC	25.2	48.8	48.8	96.8	95	1.8	12	2
	8	●	MPS1-1170-L8C	96.0	134.4	137.4	183.4	181	2.4	12	2
	10	□	MPS1-1170-L10C	119.1	158.1	161.1	207.1	205	2.1	12	2
	12	●	MPS1-1170-L12C	142.5	182.1	185.1	231.1	229	2.1	12	2
	15	●	MPS1-1170-L15C	177.6	218.1	221.1	267.1	265	2.1	12	2
	20	□	MPS1-1170-L20C	236.1	278.1	281.1	327.1	325	2.1	12	2
25	□	MPS1-1170-L25C	294.6	338.1	341.1	387.1	385	2.1	12	2	
11.8	3	□	MPS1-1180S-DIN	37.4	55.1	56.1	102.1	100	2.1	12	4
	3	●	MPS1-1180S-DIN-C	37.4	55.1	56.1	102.1	100	2.1	12	2
	5	□	MPS1-1180L-DIN	53.4	71.1	72.1	118.1	116	2.1	12	4
	5	●	MPS1-1180L-DIN-C	53.4	71.1	72.1	118.1	116	2.1	12	2
	2	●	MPS1-1180-PC	25.5	48.9	48.9	96.9	95	1.9	12	2
	8	●	MPS1-1180-L8C	96.8	134.4	137.4	183.4	181	2.4	12	2
	10	□	MPS1-1180-L10C	120.1	158.1	161.1	207.1	205	2.1	12	2
	12	●	MPS1-1180-L12C	143.7	182.1	185.1	231.1	229	2.1	12	2
	15	●	MPS1-1180-L15C	179.1	218.1	221.1	267.1	265	2.1	12	2
	20	□	MPS1-1180-L20C	238.1	278.1	281.1	327.1	325	2.1	12	2
25	□	MPS1-1180-L25C	297.1	338.1	341.1	387.1	385	2.1	12	2	

ИНСТРУМЕНТ ДЛЯ СВЕРЛЕНИЯ (МОНОЛИТНЫЕ ТВЕРДОСПЛАВНЫЕ СВЕРЛА)

MPS1

Сверхдлинные сверла с четырьмя ленточками

ТВЕРДЫЙ
СПЛАВ

M

ИНСТРУМЕНТ ДЛЯ
СВЕРЛЕНИЯ

DC (мм)	Глубина сверления (L/D)	DP1021	Обозначение	Размеры (мм)							Тип
				LU	LCF	LH	OAL	LF	PL	DCON	
11.9	3	□	MPS1-1190S-DIN	37.3	55.2	56.2	102.2	100	2.2	12	4
	3	●	MPS1-1190S-DIN-C	37.3	55.2	56.2	102.2	100	2.2	12	2
	5	□	MPS1-1190L-DIN	53.3	71.2	72.2	118.2	116	2.2	12	4
	5	●	MPS1-1190L-DIN-C	53.3	71.2	72.2	118.2	116	2.2	12	2
	2	□	MPS1-1190-PC	25.7	48.9	48.9	96.9	95	1.9	12	2
	8	●	MPS1-1190-L8C	97.7	134.5	137.5	183.5	181	2.5	12	2
	10	□	MPS1-1190-L10C	121.2	158.2	161.2	207.2	205	2.2	12	2
	12	□	MPS1-1190-L12C	145.0	182.2	185.2	231.2	229	2.2	12	2
	15	□	MPS1-1190-L15C	180.7	218.2	221.2	267.2	265	2.2	12	2
	20	□	MPS1-1190-L20C	240.2	278.2	281.2	327.2	325	2.2	12	2
25	□	MPS1-1190-L25C	299.7	338.2	341.2	387.2	385	2.2	12	2	
12.0	3	□	MPS1-1200S-DIN	37.2	55.2	56.2	102.2	100	2.2	12	4
	3	●	MPS1-1200S-DIN-C	37.2	55.2	56.2	102.2	100	2.2	12	2
	5	□	MPS1-1200L-DIN	53.2	71.2	72.2	118.2	116	2.2	12	4
	5	●	MPS1-1200L-DIN-C	53.2	71.2	72.2	118.2	116	2.2	12	2
	2	●	MPS1-1200-PC	25.9	48.9	48.9	96.9	95	1.9	12	2
	8	●	MPS1-1200-L8C	98.5	134.5	137.5	183.5	181	2.5	12	2
	10	□	MPS1-1200-L10C	122.2	158.2	161.2	207.2	205	2.2	12	2
	12	●	MPS1-1200-L12C	146.2	182.2	185.2	231.2	229	2.2	12	2
	15	●	MPS1-1200-L15C	182.2	218.2	221.2	267.2	265	2.2	12	2
	20	●	MPS1-1200-L20C	242.2	278.2	281.2	327.2	325	2.2	12	2
25	●	MPS1-1200-L25C	302.2	338.2	341.2	387.2	385	2.2	12	2	
12.05	3	□	MPS1-1205S-DIN	42.1	60.2	61.2	107.2	105	2.2	14	4
	3	●	MPS1-1205S-DIN-C	42.1	60.2	61.2	107.2	105	2.2	14	2
	5	□	MPS1-1205L-DIN	59.1	77.2	78.2	124.2	122	2.2	14	4
	5	●	MPS1-1205L-DIN-C	59.1	77.2	78.2	124.2	122	2.2	14	2
12.1	3	□	MPS1-1210S-DIN	42.1	60.2	61.2	107.2	105	2.2	14	4
	3	●	MPS1-1210S-DIN-C	42.1	60.2	61.2	107.2	105	2.2	14	2
	5	□	MPS1-1210L-DIN	59.1	77.2	78.2	124.2	122	2.2	14	4
	5	●	MPS1-1210L-DIN-C	59.1	77.2	78.2	124.2	122	2.2	14	2
	2	●	MPS1-1210-PC	26.1	52.9	55.9	103.9	102	1.9	14	2
	8	●	MPS1-1210-L8C	99.3	140.5	143.5	189.5	187	2.5	14	2
	10	□	MPS1-1210-L10C	123.2	165.2	168.2	214.2	212	2.2	14	2
	12	●	MPS1-1210-L12C	147.4	190.2	193.2	239.2	237	2.2	14	2
	15	●	MPS1-1210-L15C	183.7	227.2	230.2	276.2	274	2.2	14	2
	20	□	MPS1-1210-L20C	244.2	290.2	293.2	339.2	337	2.2	14	2
12.2	3	□	MPS1-1220S-DIN	41.9	60.2	61.2	107.2	105	2.2	14	4
	3	●	MPS1-1220S-DIN-C	41.9	60.2	61.2	107.2	105	2.2	14	2
	5	□	MPS1-1220L-DIN	58.9	77.2	78.2	124.2	122	2.2	14	4
	5	●	MPS1-1220L-DIN-C	58.9	77.2	78.2	124.2	122	2.2	14	2
	2	●	MPS1-1220-PC	26.3	52.9	55.9	103.9	102	1.9	14	2
	8	●	MPS1-1220-L8C	100.1	140.5	143.5	189.5	187	2.5	14	2
	10	□	MPS1-1220-L10C	124.2	165.2	168.2	214.2	212	2.2	14	2
	12	●	MPS1-1220-L12C	148.6	190.2	193.2	239.2	237	2.2	14	2
	15	●	MPS1-1220-L15C	185.2	227.2	230.2	276.2	274	2.2	14	2
	20	□	MPS1-1220-L20C	246.2	290.2	293.2	339.2	337	2.2	14	2
12.3	3	□	MPS1-1230S-DIN	41.8	60.2	61.2	107.2	105	2.2	14	4
	3	●	MPS1-1230S-DIN-C	41.8	60.2	61.2	107.2	105	2.2	14	2
	5	□	MPS1-1230L-DIN	58.8	77.2	78.2	124.2	122	2.2	14	4
	5	●	MPS1-1230L-DIN-C	58.8	77.2	78.2	124.2	122	2.2	14	2
	2	□	MPS1-1230-PC	26.5	52.9	55.9	103.9	102	1.9	14	2
	8	●	MPS1-1230-L8C	100.9	140.5	143.5	189.5	187	2.5	14	2
	10	□	MPS1-1230-L10C	125.2	165.2	168.2	214.2	212	2.2	14	2
	12	□	MPS1-1230-L12C	149.8	190.2	193.2	239.2	237	2.2	14	2
	15	□	MPS1-1230-L15C	186.7	227.2	230.2	276.2	274	2.2	14	2
	20	□	MPS1-1230-L20C	248.2	290.2	293.2	339.2	337	2.2	14	2

DC (мм)	Глубина сверления (L/D)	DP1021	Обозначение	Размеры (мм)							Тип
				LU	LCF	LH	OAL	LF	PL	DCON	
12.4	3	□	MPS1-1240S-DIN	41.7	60.3	61.3	107.3	105	2.3	14	4
	3	●	MPS1-1240S-DIN-C	41.7	60.3	61.3	107.3	105	2.3	14	2
	5	□	MPS1-1240L-DIN	58.7	77.3	78.3	124.3	122	2.3	14	4
	5	●	MPS1-1240L-DIN-C	58.7	77.3	78.3	124.3	122	2.3	14	2
	2	□	MPS1-1240-PC	26.8	53.0	56.0	104.0	102	2.0	14	2
	8	●	MPS1-1240-L8C	101.8	140.6	143.6	189.6	187	2.6	14	2
	10	□	MPS1-1240-L10C	126.3	165.3	168.3	214.3	212	2.3	14	2
	12	□	MPS1-1240-L12C	151.1	190.3	193.3	239.3	237	2.3	14	2
	15	□	MPS1-1240-L15C	188.3	227.3	230.3	276.3	274	2.3	14	2
	20	□	MPS1-1240-L20C	250.3	290.3	293.3	339.3	337	2.3	14	2
12.5	3	□	MPS1-1250S-DIN	41.5	60.3	61.3	107.3	105	2.3	14	4
	3	●	MPS1-1250S-DIN-C	41.5	60.3	61.3	107.3	105	2.3	14	2
	5	□	MPS1-1250L-DIN	58.5	77.3	78.3	124.3	122	2.3	14	4
	5	●	MPS1-1250L-DIN-C	58.5	77.3	78.3	124.3	122	2.3	14	2
	2	●	MPS1-1250-PC	27.0	53.0	56.0	104.0	102	2.0	14	2
	8	●	MPS1-1250-L8C	102.6	140.6	143.6	189.6	187	2.6	14	2
	10	□	MPS1-1250-L10C	127.3	165.3	168.3	214.3	212	2.3	14	2
	12	●	MPS1-1250-L12C	152.3	190.3	193.3	239.3	237	2.3	14	2
	15	●	MPS1-1250-L15C	189.8	227.3	230.3	276.3	274	2.3	14	2
	20	□	MPS1-1250-L20C	252.3	290.3	293.3	339.3	337	2.3	14	2
12.6	3	□	MPS1-1260S-DIN	41.4	60.3	61.3	107.3	105	2.3	14	4
	3	●	MPS1-1260S-DIN-C	41.4	60.3	61.3	107.3	105	2.3	14	2
	5	□	MPS1-1260L-DIN	58.4	77.3	78.3	124.3	122	2.3	14	4
	5	●	MPS1-1260L-DIN-C	58.4	77.3	78.3	124.3	122	2.3	14	2
	2	□	MPS1-1260-PC	27.2	53.0	55.0	104.0	102	2.0	14	2
	8	●	MPS1-1260-L8C	103.4	145.6	148.6	194.6	192	2.6	14	2
	10	□	MPS1-1260-L10C	128.3	171.3	174.3	220.3	218	2.3	14	2
	12	□	MPS1-1260-L12C	153.5	197.3	200.3	246.3	244	2.3	14	2
	15	□	MPS1-1260-L15C	191.3	236.3	239.3	285.3	283	2.3	14	2
	20	□	MPS1-1260-L20C	254.3	301.3	304.3	350.3	348	2.3	14	2
12.7	3	□	MPS1-1270S-DIN	41.3	60.3	61.3	107.3	105	2.3	14	4
	3	●	MPS1-1270S-DIN-C	41.3	60.3	61.3	107.3	105	2.3	14	2
	5	□	MPS1-1270L-DIN	58.3	77.3	78.3	124.3	122	2.3	14	4
	5	●	MPS1-1270L-DIN-C	58.3	77.3	78.3	124.3	122	2.3	14	2
	2	□	MPS1-1270-PC	27.4	53.0	55.0	104.0	102	2.0	14	2
	8	●	MPS1-1270-L8C	104.2	145.6	148.6	194.6	192	2.6	14	2
	10	□	MPS1-1270-L10C	129.3	171.3	174.3	220.3	218	2.3	14	2
	12	●	MPS1-1270-L12C	154.7	197.3	200.3	246.3	244	2.3	14	2
	15	□	MPS1-1270-L15C	192.8	236.3	239.3	285.3	283	2.3	14	2
	20	□	MPS1-1270-L20C	256.3	301.3	304.3	350.3	348	2.3	14	2
12.8	3	□	MPS1-1280S-DIN	41.1	60.3	61.3	107.3	105	2.3	14	4
	3	●	MPS1-1280S-DIN-C	41.1	60.3	61.3	107.3	105	2.3	14	2
	5	□	MPS1-1280L-DIN	58.1	77.3	78.3	124.3	122	2.3	14	4
	5	●	MPS1-1280L-DIN-C	58.1	77.3	78.3	124.3	122	2.3	14	2
	2	●	MPS1-1280-PC	27.6	53.0	55.0	104.0	102	2.0	14	2
	8	●	MPS1-1280-L8C	105.1	145.7	148.7	194.7	192	2.7	14	2
	10	□	MPS1-1280-L10C	130.3	171.3	174.3	220.3	218	2.3	14	2
	12	●	MPS1-1280-L12C	155.9	197.3	200.3	246.3	244	2.3	14	2
	15	□	MPS1-1280-L15C	194.3	236.3	239.3	285.3	283	2.3	14	2
	20	□	MPS1-1280-L20C	258.3	301.3	304.3	350.3	348	2.3	14	2

● : Есть на складе. □ : Нет на складе, выпускается исключительно под заказ.

DC (мм)	Глубина сверления (L/D)	DP1021	Обозначение	Размеры (мм)							Тип
				LU	LCF	LH	OAL	LF	PL	DCON	
12.9	3	□	MPS1-1290S-DIN	41.0	60.3	61.3	107.3	105	2.3	14	4
	3	●	MPS1-1290S-DIN-C	41.0	60.3	61.3	107.3	105	2.3	14	2
	5	□	MPS1-1290L-DIN	58.0	77.3	78.3	124.3	122	2.3	14	4
	5	●	MPS1-1290L-DIN-C	58.0	77.3	78.3	124.3	122	2.3	14	2
	2	□	MPS1-1290-PC	27.8	53.0	55.0	104.0	102	2.0	14	2
	8	●	MPS1-1290-L8C	105.9	145.7	148.7	194.7	192	2.7	14	2
	10	□	MPS1-1290-L10C	131.3	171.3	174.3	220.3	218	2.3	14	2
	12	□	MPS1-1290-L12C	157.1	197.3	200.3	246.3	244	2.3	14	2
	15	□	MPS1-1290-L15C	195.8	236.3	239.3	285.3	283	2.3	14	2
	20	□	MPS1-1290-L20C	260.3	301.3	304.3	350.3	348	2.3	14	2
13.0	3	□	MPS1-1300S-DIN	40.9	60.4	61.4	107.4	105	2.4	14	4
	3	●	MPS1-1300S-DIN-C	40.9	60.4	61.4	107.4	105	2.4	14	2
	5	□	MPS1-1300L-DIN	57.9	77.4	78.4	124.4	122	2.4	14	4
	5	●	MPS1-1300L-DIN-C	57.9	77.4	78.4	124.4	122	2.4	14	2
	2	●	MPS1-1300-PC	28.0	53.0	55.0	104.0	102	2.0	14	2
	8	●	MPS1-1300-L8C	106.7	145.7	148.7	194.7	192	2.7	14	2
	10	□	MPS1-1300-L10C	132.4	171.4	174.4	220.4	218	2.4	14	2
	12	●	MPS1-1300-L12C	158.4	197.4	200.4	246.4	244	2.4	14	2
	15	●	MPS1-1300-L15C	197.4	236.4	239.4	285.4	283	2.4	14	2
	20	●	MPS1-1300-L20C	262.4	301.4	304.4	350.4	348	2.4	14	2
13.1	3	□	MPS1-1310S-DIN	40.7	60.4	61.4	107.4	105	2.4	14	4
	3	●	MPS1-1310S-DIN-C	40.7	60.4	61.4	107.4	105	2.4	14	2
	5	□	MPS1-1310L-DIN	57.7	77.4	78.4	124.4	122	2.4	14	4
	5	●	MPS1-1310L-DIN-C	57.7	77.4	78.4	124.4	122	2.4	14	2
	2	□	MPS1-1310-PC	28.3	56.1	59.1	109.1	107	2.1	14	2
	8	●	MPS1-1310-L8C	107.5	151.7	154.7	200.7	198	2.7	14	2
	10	□	MPS1-1310-L10C	133.4	178.4	181.4	227.4	225	2.4	14	2
	12	□	MPS1-1310-L12C	159.6	205.4	208.4	254.4	252	2.4	14	2
	15	□	MPS1-1310-L15C	198.9	245.4	248.4	294.4	292	2.4	14	2
	20	□	MPS1-1310-L20C	264.4	313.4	316.4	362.4	360	2.4	14	2
13.2	3	□	MPS1-1320S-DIN	40.6	60.4	61.4	107.4	105	2.4	14	4
	3	●	MPS1-1320S-DIN-C	40.6	60.4	61.4	107.4	105	2.4	14	2
	5	□	MPS1-1320L-DIN	57.6	77.4	78.4	124.4	122	2.4	14	4
	5	●	MPS1-1320L-DIN-C	57.6	77.4	78.4	124.4	122	2.4	14	2
	2	●	MPS1-1320-PC	28.5	56.1	59.1	109.1	107	2.1	14	2
	8	●	MPS1-1320-L8C	108.3	151.7	154.7	200.7	198	2.7	14	2
	10	□	MPS1-1320-L10C	134.4	178.4	181.4	227.4	225	2.4	14	2
	12	●	MPS1-1320-L12C	160.8	205.4	208.4	254.4	252	2.4	14	2
	15	□	MPS1-1320-L15C	200.4	245.4	248.4	294.4	292	2.4	14	2
	20	□	MPS1-1320-L20C	266.4	313.4	316.4	362.4	360	2.4	14	2
13.3	3	□	MPS1-1330S-DIN	40.5	60.4	61.4	107.4	105	2.4	14	4
	3	●	MPS1-1330S-DIN-C	40.5	60.4	61.4	107.4	105	2.4	14	2
	5	□	MPS1-1330L-DIN	57.5	77.4	78.4	124.4	122	2.4	14	4
	5	●	MPS1-1330L-DIN-C	57.5	77.4	78.4	124.4	122	2.4	14	2
	2	□	MPS1-1330-PC	28.7	56.1	59.1	109.1	107	2.1	14	2
	8	●	MPS1-1330-L8C	109.2	151.8	154.8	200.8	198	2.8	14	2
	10	□	MPS1-1330-L10C	135.4	178.4	181.4	227.4	225	2.4	14	2
	12	□	MPS1-1330-L12C	162.0	205.4	208.4	254.4	252	2.4	14	2
	15	□	MPS1-1330-L15C	201.9	245.4	248.4	294.4	292	2.4	14	2
	20	□	MPS1-1330-L20C	268.4	313.4	316.4	362.4	360	2.4	14	2

DC (мм)	Глубина сверления (L/D)	DP1021	Обозначение	Размеры (мм)							Тип
				LU	LCF	LH	OAL	LF	PL	DCON	
13.4	3	□	MPS1-1340S-DIN	40.3	60.4	61.4	107.4	105	2.4	14	4
	3	●	MPS1-1340S-DIN-C	40.3	60.4	61.4	107.4	105	2.4	14	2
	5	□	MPS1-1340L-DIN	57.3	77.4	78.4	124.4	122	2.4	14	4
	5	●	MPS1-1340L-DIN-C	57.3	77.4	78.4	124.4	122	2.4	14	2
	2	□	MPS1-1340-PC	28.9	56.1	59.1	109.1	107	2.1	14	2
	8	●	MPS1-1340-L8C	110.0	151.8	154.8	200.8	198	2.8	14	2
	10	□	MPS1-1340-L10C	136.4	178.4	181.4	227.4	225	2.4	14	2
	12	□	MPS1-1340-L12C	163.2	205.4	208.4	254.4	252	2.4	14	2
	15	□	MPS1-1340-L15C	203.4	245.4	248.4	294.4	292	2.4	14	2
	20	□	MPS1-1340-L20C	270.4	313.4	316.4	362.4	360	2.4	14	2
13.5	3	□	MPS1-1350S-DIN	40.2	60.5	61.5	107.5	105	2.5	14	4
	3	●	MPS1-1350S-DIN-C	40.2	60.5	61.5	107.5	105	2.5	14	2
	5	□	MPS1-1350L-DIN	57.2	77.5	78.5	124.5	122	2.5	14	4
	5	●	MPS1-1350L-DIN-C	57.2	77.5	78.5	124.5	122	2.5	14	2
	2	●	MPS1-1350-PC	29.1	56.1	59.1	109.1	107	2.1	14	2
	8	●	MPS1-1350-L8C	110.8	151.8	154.8	200.8	198	2.8	14	2
	10	□	MPS1-1350-L10C	137.5	178.5	181.5	227.5	225	2.5	14	2
	12	●	MPS1-1350-L12C	164.5	205.5	208.5	254.5	252	2.5	14	2
	15	□	MPS1-1350-L15C	205.0	245.5	248.5	294.5	292	2.5	14	2
	20	□	MPS1-1350-L20C	272.5	313.5	316.5	362.5	360	2.5	14	2
13.6	3	□	MPS1-1360S-DIN	40.1	60.5	61.5	107.5	105	2.5	14	4
	3	●	MPS1-1360S-DIN-C	40.1	60.5	61.5	107.5	105	2.5	14	2
	5	□	MPS1-1360L-DIN	57.1	77.5	78.5	124.5	122	2.5	14	4
	5	●	MPS1-1360L-DIN-C	57.1	77.5	78.5	124.5	122	2.5	14	2
	2	□	MPS1-1360-PC	29.3	56.1	59.1	109.1	107	2.1	14	2
	8	●	MPS1-1360-L8C	111.6	156.8	159.8	205.8	203	2.8	14	2
	10	□	MPS1-1360-L10C	138.5	184.5	187.5	233.5	231	2.5	14	2
	12	□	MPS1-1360-L12C	165.7	212.5	215.5	261.5	259	2.5	14	2
	15	□	MPS1-1360-L15C	206.5	254.5	257.5	303.5	301	2.5	14	2
	20	□	MPS1-1360-L20C	274.5	324.5	327.5	373.5	371	2.5	14	2
13.7	3	□	MPS1-1370S-DIN	39.9	60.5	61.5	107.5	105	2.5	14	4
	3	●	MPS1-1370S-DIN-C	39.9	60.5	61.5	107.5	105	2.5	14	2
	5	□	MPS1-1370L-DIN	56.9	77.5	78.5	124.5	122	2.5	14	4
	5	●	MPS1-1370L-DIN-C	56.9	77.5	78.5	124.5	122	2.5	14	2
	2	□	MPS1-1370-PC	29.6	56.2	59.2	109.2	107	2.2	14	2
	8	●	MPS1-1370-L8C	112.4	156.8	159.8	205.8	203	2.8	14	2
	10	□	MPS1-1370-L10C	139.5	184.5	187.5	233.5	231	2.5	14	2
	12	□	MPS1-1370-L12C	166.9	212.5	215.5	261.5	259	2.5	14	2
	15	□	MPS1-1370-L15C	208.0	254.5	257.5	303.5	301	2.5	14	2
	20	□	MPS1-1370-L20C	276.5	324.5	327.5	373.5	371	2.5	14	2
13.8	3	□	MPS1-1380S-DIN	39.8	60.5	61.5	107.5	105	2.5	14	4
	3	●	MPS1-1380S-DIN-C	39.8	60.5	61.5	107.5	105	2.5	14	2
	5	□	MPS1-1380L-DIN	56.8	77.5	78.5	124.5	122	2.5	14	4
	5	●	MPS1-1380L-DIN-C	56.8	77.5	78.5	124.5	122	2.5	14	2
	2	□	MPS1-1380-PC	29.8	56.2	59.2	109.2	107	2.2	14	2
	8	●	MPS1-1380-L8C	113.3	156.9	159.9	205.9	203	2.9	14	2
	10	□	MPS1-1380-L10C	140.5	184.5	187.5	233.5	231	2.5	14	2
	12	□	MPS1-1380-L12C	168.1	212.5	215.5	261.5	259	2.5	14	2
	15	□	MPS1-1380-L15C	209.5	254.5	257.5	303.5	301	2.5	14	2
	20	□	MPS1-1380-L20C	278.5	324.5	327.5	373.5	371	2.5	14	2

ИНСТРУМЕНТ ДЛЯ СВЕРЛЕНИЯ (МОНОЛИТНЫЕ ТВЕРДОСПЛАВНЫЕ СВЕРЛА)

MPS1

Сверхдлинные сверла с четырьмя ленточками

ТВЕРДЫЙ
СПЛАВ

M

ИНСТРУМЕНТ ДЛЯ
СВЕРЛЕНИЯ

DC (мм)	Глубина сверления (L/D)	DP1021	Обозначение	Размеры (мм)							Тип
				LU	LCF	LH	OAL	LF	PL	DCON	
13.9	3	□	MPS1-1390S-DIN	39.7	60.5	61.5	107.5	105	2.5	14	4
	3	●	MPS1-1390S-DIN-C	39.7	60.5	61.5	107.5	105	2.5	14	2
	5	□	MPS1-1390L-DIN	56.7	77.5	78.5	124.5	122	2.5	14	4
	5	●	MPS1-1390L-DIN-C	56.7	77.5	78.5	124.5	122	2.5	14	2
	2	□	MPS1-1390-PC	30.0	56.2	56.2	109.2	107	2.2	14	2
	8	●	MPS1-1390-L8C	114.1	156.9	159.9	205.9	203	2.9	14	2
	10	□	MPS1-1390-L10C	141.5	184.5	187.5	233.5	231	2.5	14	2
	12	□	MPS1-1390-L12C	169.3	212.5	215.5	261.5	259	2.5	14	2
	15	□	MPS1-1390-L15C	211.0	254.5	257.5	303.5	301	2.5	14	2
	20	□	MPS1-1390-L20C	280.5	324.5	327.5	373.5	371	2.5	14	2
14.0	3	□	MPS1-1400S-DIN	39.5	60.5	61.5	107.5	105	2.5	14	4
	3	●	MPS1-1400S-DIN-C	39.5	60.5	61.5	107.5	105	2.5	14	2
	5	□	MPS1-1400L-DIN	56.5	77.5	78.5	124.5	122	2.5	14	4
	5	●	MPS1-1400L-DIN-C	56.5	77.5	78.5	124.5	122	2.5	14	2
	2	□	MPS1-1400-PC	30.2	56.2	56.2	109.2	107	2.2	14	2
	8	●	MPS1-1400-L8C	114.9	156.9	159.9	205.9	203	2.9	14	2
	10	□	MPS1-1400-L10C	142.5	184.5	187.5	233.5	231	2.5	14	2
	12	●	MPS1-1400-L12C	170.5	212.5	215.5	261.5	259	2.5	14	2
	15	●	MPS1-1400-L15C	212.5	254.5	257.5	303.5	301	2.5	14	2
	20	●	MPS1-1400-L20C	282.5	324.5	327.5	373.5	371	2.5	14	2
14.2	3	□	MPS1-1420S-DIN	43.3	64.6	65.6	114.6	112	2.6	16	4
	3	●	MPS1-1420S-DIN-C	43.3	64.6	65.6	114.6	112	2.6	16	2
	5	□	MPS1-1420L-DIN	61.3	82.6	83.6	132.6	130	2.6	16	4
	5	●	MPS1-1420L-DIN-C	61.3	82.6	83.6	132.6	130	2.6	16	2
14.5	3	□	MPS1-1450S-DIN	42.9	64.6	65.6	114.6	112	2.6	16	4
	3	●	MPS1-1450S-DIN-C	42.9	64.6	65.6	114.6	112	2.6	16	2
	5	□	MPS1-1450L-DIN	60.9	82.6	83.6	132.6	130	2.6	16	4
	5	●	MPS1-1450L-DIN-C	60.9	82.6	83.6	132.6	130	2.6	16	2
15.0	3	□	MPS1-1500S-DIN	42.2	64.7	65.7	114.7	112	2.7	16	4
	3	●	MPS1-1500S-DIN-C	42.2	64.7	65.7	114.7	112	2.7	16	2
	5	□	MPS1-1500L-DIN	60.2	82.7	83.7	132.7	130	2.7	16	4
	5	●	MPS1-1500L-DIN-C	60.2	82.7	83.7	132.7	130	2.7	16	2
15.5	3	□	MPS1-1550S-DIN	41.6	64.8	65.8	114.8	112	2.8	16	4
	3	●	MPS1-1550S-DIN-C	41.6	64.8	65.8	114.8	112	2.8	16	2
	5	□	MPS1-1550L-DIN	59.6	82.8	83.8	132.8	130	2.8	16	4
	5	●	MPS1-1550L-DIN-C	59.6	82.8	83.8	132.8	130	2.8	16	2
16.0	3	□	MPS1-1600S-DIN	40.9	64.9	65.9	114.9	112	2.9	16	4
	3	●	MPS1-1600S-DIN-C	40.9	64.9	65.9	114.9	112	2.9	16	2
	5	□	MPS1-1600L-DIN	58.9	82.9	83.9	132.9	130	2.9	16	4
	5	●	MPS1-1600L-DIN-C	58.9	82.9	83.9	132.9	130	2.9	16	2
16.5	3	□	MPS1-1650S-DIN	48.3	73.0	74.0	123.0	120	3.0	18	4
	3	●	MPS1-1650S-DIN-C	48.3	73.0	74.0	123.0	120	3.0	18	2
	5	□	MPS1-1650L-DIN	68.3	93.0	94.0	143.0	140	3.0	18	4
	5	●	MPS1-1650L-DIN-C	68.3	93.0	94.0	143.0	140	3.0	18	2
17.0	3	□	MPS1-1700S-DIN	47.6	73.1	74.1	123.1	120	3.1	18	4
	3	●	MPS1-1700S-DIN-C	47.6	73.1	74.1	123.1	120	3.1	18	2
	5	□	MPS1-1700L-DIN	67.6	93.1	94.1	143.1	140	3.1	18	4
	5	●	MPS1-1700L-DIN-C	67.6	93.1	94.1	143.1	140	3.1	18	2
17.5	3	□	MPS1-1750S-DIN	46.9	73.2	74.2	123.2	120	3.2	18	4
	3	●	MPS1-1750S-DIN-C	46.9	73.2	74.2	123.2	120	3.2	18	2
	5	□	MPS1-1750L-DIN	66.9	93.2	94.2	143.2	140	3.2	18	4
	5	●	MPS1-1750L-DIN-C	66.9	93.2	94.2	143.2	140	3.2	18	2
18.0	3	□	MPS1-1800S-DIN	46.3	73.3	74.3	123.3	120	3.3	18	4
	3	●	MPS1-1800S-DIN-C	46.3	73.3	74.3	123.3	120	3.3	18	2
	5	□	MPS1-1800L-DIN	66.3	93.3	94.3	143.3	140	3.3	18	4
	5	●	MPS1-1800L-DIN-C	66.3	93.3	94.3	143.3	140	3.3	18	2

DC (мм)	Глубина сверления (L/D)	DP1021	Обозначение	Размеры (мм)							Тип
				LU	LCF	LH	OAL	LF	PL	DCON	
18.5	3	□	MPS1-1850S-DIN	51.6	79.4	80.4	131.4	128	3.4	20	4
	3	●	MPS1-1850S-DIN-C	51.6	79.4	80.4	131.4	128	3.4	20	2
	5	□	MPS1-1850L-DIN	73.6	101.4	102.4	153.4	150	3.4	20	4
	5	●	MPS1-1850L-DIN-C	73.6	101.4	102.4	153.4	150	3.4	20	2
19.0	3	□	MPS1-1900S-DIN	51.0	79.5	80.5	131.5	128	3.5	20	4
	3	●	MPS1-1900S-DIN-C	51.0	79.5	80.5	131.5	128	3.5	20	2
	5	□	MPS1-1900L-DIN	73.0	101.5	102.5	153.5	150	3.5	20	4
	5	●	MPS1-1900L-DIN-C	73.0	101.5	102.5	153.5	150	3.5	20	2
19.5	3	□	MPS1-1950S-DIN	50.3	79.5	80.5	131.5	128	3.5	20	4
	3	●	MPS1-1950S-DIN-C	50.3	79.5	80.5	131.5	128	3.5	20	2
	5	□	MPS1-1950L-DIN	72.3	101.5	102.5	153.5	150	3.5	20	4
	5	●	MPS1-1950L-DIN-C	72.3	101.5	102.5	153.5	150	3.5	20	2
20.0	3	□	MPS1-2000S-DIN	49.6	79.6	80.6	131.6	128	3.6	20	4
	3	●	MPS1-2000S-DIN-C	49.6	79.6	80.6	131.6	128	3.6	20	2
	5	□	MPS1-2000L-DIN	71.6	101.6	102.6	153.6	150	3.6	20	4
	5	●	MPS1-2000L-DIN-C	71.6	101.6	102.6	153.6	150	3.6	20	2

● : Есть на складе. □ : Нет на складе, выпускается исключительно под заказ.

РЕКОМЕНДУЕМЫЕ РЕЖИМЫ РЕЗАНИЯ

● MPS1 СВЕРЛА (3хDC – 40хDC)

DC	L x DC		P			M	K		
			Малоуглеродистые стали, Углеродистая сталь, Легированная сталь			Нержавеющая сталь	Чугун		
			≤ 180 НВ	180–250 НВ	280–350 НВ		≤ 350 МПа	≤ 450 МПа	≤ 800 МПа
3	3–8	Vc м/мин	100 (60–150)	90 (60–140)	80 (50–110)	40 (20–50)	90 (60–100)	80 (50–90)	60 (40–80)
		f мм/об	0.15 (0.1–0.2)	0.15 (0.1–0.19)	0.12 (0.1–0.14)	0.08 (0.06–0.12)	0.15 (0.1–0.2)	0.12 (0.08–0.16)	0.09 (0.06–0.12)
	10–25	Vc м/мин	90 (40–110)	90 (40–110)	80 (40–90)	40 (20–60)	90 (40–110)	90 (40–110)	—
		f мм/об	0.17 (0.1–0.24)	0.17 (0.1–0.24)	0.15 (0.09–0.22)	0.07 (0.05–0.09)	0.19 (0.11–0.26)	0.17 (0.1–0.24)	—
	30–40	Vc м/мин	75 (40–95)	75 (40–85)	65 (40–75)	30 (20–50)	75 (45–95)	30 (20–50)	—
		f мм/об	0.14 (0.08–0.19)	0.14 (0.08–0.19)	0.15 (0.07–0.18)	0.06 (0.04–0.07)	0.15 (0.09–0.21)	0.14 (0.08–0.19)	—
4	3–8	Vc м/мин	120 (70–170)	100 (70–160)	90 (60–120)	40 (30–50)	100 (70–110)	90 (60–100)	70 (50–90)
		f мм/об	0.19 (0.12–0.25)	0.18 (0.12–0.24)	0.15 (0.12–0.18)	0.09 (0.07–0.13)	0.21 (0.12–0.3)	0.17 (0.1–0.24)	0.13 (0.08–0.18)
	10–25	Vc м/мин	90 (40–110)	90 (40–110)	80 (40–90)	40 (20–60)	90 (40–110)	90 (40–110)	—
		f мм/об	0.2 (0.12–0.3)	0.2 (0.12–0.3)	0.18 (0.11–0.27)	0.08 (0.06–0.1)	0.22(0.13–0.33)	0.2 (0.12–0.3)	—
	30–40	Vc м/мин	75 (40–95)	75 (40–85)	65 (40–75)	30 (20–50)	75 (45–95)	30 (20–50)	—
		f мм/об	0.16 (0.1–0.24)	0.16 (0.1–0.24)	0.18 (0.09–0.22)	0.06 (0.05–0.08)	0.18 (0.1–0.26)	0.16 (0.1–0.24)	—
5	3–8	Vc м/мин	130 (80–190)	110 (80–180)	90 (70–140)	40 (30–50)	110 (80–130)	90 (70–120)	70 (60–100)
		f мм/об	0.23 (0.15–0.3)	0.22 (0.15–0.29)	0.19 (0.15–0.22)	0.11 (0.08–0.16)	0.25 (0.15–0.35)	0.21 (0.14–0.28)	0.17 (0.12–0.22)
	10–25	Vc м/мин	90 (40–110)	90 (40–110)	80 (40–90)	40 (20–60)	90 (40–110)	90 (40–110)	—
		f мм/об	0.25 (0.15–0.35)	0.25 (0.15–0.35)	0.22 (0.14–0.32)	0.1 (0.07–0.12)	0.28 (0.17–0.39)	0.25 (0.15–0.35)	—
	30–40	Vc м/мин	75 (40–95)	75 (40–85)	65 (40–75)	30 (20–50)	75 (45–95)	30 (20–50)	—
		f мм/об	0.2 (0.12–0.28)	0.2 (0.12–0.28)	0.22 (0.11–0.26)	0.08 (0.06–0.1)	0.22 (0.13–0.31)	0.2 (0.12–0.28)	—
6	3–8	Vc м/мин	140 (90–210)	120 (90–190)	100 (80–150)	50 (40–70)	120 (90–140)	100 (80–130)	80 (70–110)
		f мм/об	0.27 (0.18–0.35)	0.26 (0.18–0.33)	0.22 (0.18–0.25)	0.14 (0.11–0.18)	0.29 (0.18–0.4)	0.25 (0.16–0.34)	0.2 (0.14–0.26)
	10–25	Vc м/мин	110 (70–120)	100 (60–110)	90 (40–110)	50 (20–60)	100 (60–110)	100 (60–110)	—
		f мм/об	0.27 (0.17–0.37)	0.24 (0.15–0.33)	0.24 (0.15–0.33)	0.12 (0.08–0.16)	0.3 (0.19–0.41)	0.27 (0.17–0.37)	—
	30–40	Vc м/мин	90 (40–110)	80 (40–90)	75 (40–85)	40 (20–60)	90 (60–110)	40 (30–60)	—
		f мм/об	0.22 (0.14–0.3)	0.22 (0.14–0.3)	0.24 (0.12–0.26)	0.1 (0.06–0.13)	0.24 (0.15–0.33)	0.22 (0.14–0.3)	—
8	3–8	Vc м/мин	160 (100–240)	140 (100–220)	120 (90–170)	50 (40–70)	140 (100–160)	120 (90–150)	100 (80–130)
		f мм/об	0.3 (0.2–0.4)	0.29 (0.2–0.38)	0.24 (0.2–0.27)	0.15 (0.12–0.2)	0.33 (0.2–0.45)	0.28 (0.18–0.38)	0.23 (0.16–0.3)
	10–25	Vc м/мин	110 (70–120)	100 (60–110)	90 (40–110)	50 (20–60)	100 (60–110)	100 (60–110)	—
		f мм/об	0.3 (0.2–0.4)	0.3 (0.2–0.4)	0.27 (0.18–0.36)	0.14 (0.1–0.17)	0.33 (0.22–0.44)	0.3 (0.2–0.4)	—
	30–40	Vc м/мин	90 (40–110)	80 (40–90)	75 (40–85)	40 (20–50)	90 (60–100)	40 (30–60)	—
		f мм/об	0.24 (0.16–0.32)	0.24 (0.16–0.32)	0.27 (0.14–0.29)	0.11 (0.08–0.14)	0.26 (0.18–0.35)	0.24 (0.16–0.32)	—
10	3–8	Vc м/мин	170 (100–250)	150 (100–230)	130 (90–180)	50 (40–70)	150 (100–170)	130 (90–160)	110 (80–140)
		f мм/об	0.33 (0.2–0.45)	0.32 (0.2–0.43)	0.25 (0.2–0.3)	0.16 (0.12–0.22)	0.35 (0.2–0.5)	0.29 (0.18–0.4)	0.24 (0.16–0.32)
	10–25	Vc м/мин	110 (70–120)	100 (60–110)	90 (40–110)	50 (20–60)	100 (60–110)	100 (60–110)	—
		f мм/об	0.32 (0.22–0.42)	0.32 (0.22–0.42)	0.29 (0.2–0.38)	0.15 (0.12–0.18)	0.35 (0.24–0.46)	0.32 (0.22–0.42)	—
	30–40	Vc м/мин	90 (40–110)	80 (40–90)	75 (40–95)	40 (20–50)	90 (60–100)	40 (30–60)	—
		f мм/об	0.26 (0.18–0.34)	0.26 (0.18–0.34)	0.29 (0.16–0.3)	0.12 (0.1–0.14)	0.28 (0.19–0.37)	0.26 (0.18–0.34)	—
12	3–8	Vc м/мин	180 (100–250)	160 (100–230)	140 (90–180)	50 (40–70)	160 (100–170)	140 (90–160)	110 (80–140)
		f мм/об	0.35 (0.2–0.5)	0.34 (0.2–0.48)	0.27 (0.2–0.34)	0.18 (0.14–0.24)	0.4 (0.2–0.6)	0.31 (0.18–0.44)	0.25 (0.16–0.34)
	10–25	Vc м/мин	130 (90–150)	120 (80–140)	100 (60–110)	60 (25–65)	120 (90–140)	120 (90–140)	—
		f мм/об	0.34 (0.24–0.44)	0.34 (0.24–0.44)	0.3 (0.22–0.4)	0.17 (0.14–0.19)	0.37 (0.26–0.48)	0.34 (0.24–0.44)	—
	30–40	Vc м/мин	105 (55–125)	95 (55–105)	80 (40–100)	50 (20–60)	105 (65–115)	50 (40–70)	—
		f мм/об	0.27 (0.19–0.35)	0.27 (0.19–0.35)	0.3 (0.18–0.32)	0.14 (0.11–0.15)	0.3 (0.21–0.38)	0.27 (0.19–0.35)	—
16	3–8	Vc м/мин	180 (100–250)	160 (100–230)	140 (90–180)	50 (40–70)	160 (100–170)	140 (90–160)	110 (80–140)
		f мм/об	0.38 (0.2–0.55)	0.36 (0.2–0.52)	0.28 (0.2–0.36)	0.19 (0.15–0.26)	0.43 (0.2–0.65)	0.33 (0.18–0.48)	0.27 (0.16–0.38)
	10–25	Vc м/мин	130 (90–150)	120 (80–140)	100 (60–110)	60 (25–65)	120 (90–140)	120 (90–140)	—
		f мм/об	0.36 (0.26–0.46)	0.36 (0.26–0.46)	0.32 (0.23–0.41)	0.17 (0.14–0.19)	0.4 (0.29–0.48)	0.36 (0.26–0.46)	—
20	3–8	Vc м/мин	180 (100–250)	160 (100–230)	140 (90–180)	50 (40–70)	160 (100–170)	140 (90–160)	110 (80–140)
		f мм/об	0.4 (0.2–0.6)	0.39 (0.2–0.57)	0.3 (0.2–0.4)	0.21 (0.16–0.28)	0.45 (0.2–0.7)	0.35 (0.18–0.52)	0.28 (0.16–0.4)

MPS1

Сверхдлинные сверла с четырьмя ленточками

РУКОВОДСТВО ПО ИСПОЛЬЗОВАНИЮ MPS1

Крепление сверла

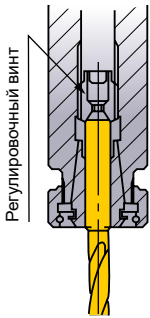

Цанговый патрон с упорным подшипником надежно держит сверло.

Длина сверла

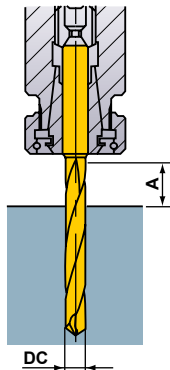

$$A \geq DC \times 1.5$$

Установка сверла

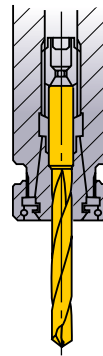

Не прижимать по режущей кромке.

Допуск на установку

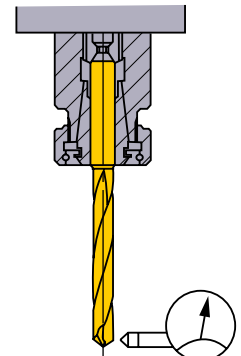

Биение $\leq 0.03\text{мм}$

Тип охлаждения через сквозные отверстия

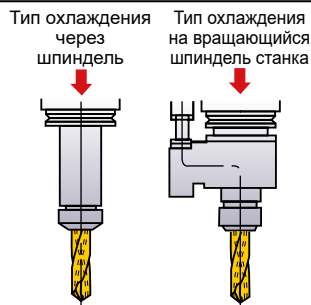

Давление СОЖ приблизительно. 5–10 Бар ($< \phi 5: 2-30$ Бар).

Рекомендации по использованию СОЖ

- 1) Мелкая металлическая стружка забивается в отверстие для подачи СОЖ в сверлах малого диаметра. Для предотвращения этого процесса обязательно используйте мелкий сетчатый фильтр.
- 2) Частицы грязи и пыли прилипают к маслу в составе СОЖ и препятствуют эффективной подаче СОЖ. Рекомендуется регулярно менять СОЖ.

Тонкая заготовка

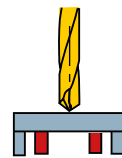

OK

Необходима опора для заготовки.

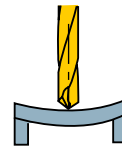

X

Если наблюдается отгиб.

Прерывистое резание

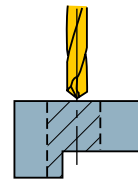

Один процесс **OK**

① Уменьшить подачу при сверлении разомкнутой детали (при прерывистом сверлении).

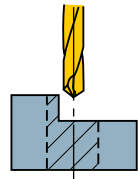

Требуется предварительная обработка.

① До сверления предварительно подрезать торец концевой фрезой.

Ступенчатые отверстия

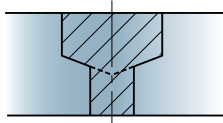

- ① Разделите два указанных процесса.
 - ② Сначала просверлите отверстие большего диаметра.
- *Инструмент, применимый как для снятия фаски, так и для подрезки торца, может быть изготовлен на заказ.

Образование заусенцев и выкрашивание заготовки.

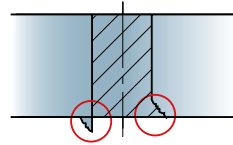

- ① Снизить скорость подачи на 50% в конце сквозной обработки.
- ② Добавить фаску 45°
- ③ Измените угол при вершине.

M

ИНСТРУМЕНТ ДЛЯ СВЕРЛЕНИЯ

РУКОВОДСТВО ПО ИСПОЛЬЗОВАНИЮ СЕРИЙ ДЛИННЫХ СВЕРЛ

СВЕРЛЕНИЕ НА ПЛОСКИХ ПОВЕРХНОСТЯХ ● Сделать глухое отверстие

■ 1. Выполнить направляющее отверстие

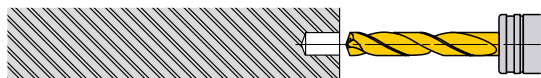

- ① Используйте сверло с большим двойным углом в плане, чем у сверла длинного исполнения. Используйте сверло с минимальной длиной режущей кромки.
- ② Для обеспечения высокой точности отверстия, точно выполняйте направляющее отверстие.
- ③ Глубина сверления: около 1DC или глубже.
(Выберите глубину направляющего отверстия, соответствующую длине сверхдлинного сверла.)

■ 2. Предварительная обработка при помощи длинного сверла



- ① Вводите сверло в направляющее отверстие при низких оборотах (вращение 1000 мин^{-1} , скорость подачи $0,2-0,3 \text{ мм/об}$).
- ② Остановить сверло для глубоких отверстий $0,5-1 \text{ мм}$ до достижения дна направляющего отверстия.

■ 3. Сверление глубокого отверстия

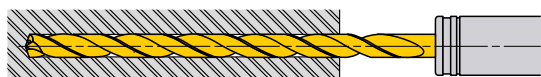

- ① Увеличьте частоту вращения и подачу за цикл и просверлите до желаемой глубины.

■ 4. Отвод сверла из отверстия



- ① После окончания сверления снизьте обороты, не доходя приблизительно $0,5-1 \text{ мм}$ до конца отверстия (частота вращения около 1000 мин^{-1}).
- ② Выньте сверло примерно до глубины направляющего отверстия ($V_f=3000 \text{ мм/мин}$.)
- ③ Выведите сверло из направляющего отверстия с уменьшенной частотой вращения ($n=300$, $V_f=3000 \text{ мм/мин}$)

СВЕРЛЕНИЕ НА НАКЛОННЫХ ПОВЕРХНОСТЯХ ● Отверстия на изогнутых заготовках

■ 1. Фрезерование плоских поверхностей



- ① Отфрезеруйте плоскую поверхность на заготовке фрезой, такого же диаметра, что и диаметр желаемого отверстия.

■ 2. Выполнить направляющее отверстие



- ① Используйте сверло с большим двойным углом в плане, чем у сверла длинного исполнения. Используйте сверло с минимальной длиной режущей кромки.
- ② Для обеспечения высокой точности отверстия, точно выполняйте направляющее отверстие.
- ③ Глубина сверления: около 1DC или глубже.
(Выберите глубину направляющего отверстия, соответствующую длине сверхдлинного сверла.)

■ 3. Предварительная обработка при помощи длинного сверла



- ① Вводите сверло в направляющее отверстие на низких оборотах (частота вращения 1000 мин^{-1} , скорость подачи $0,2-0,3 \text{ мм/об}$).
- ② Остановить длинное сверло за $0,5-1 \text{ мм}$ до достижения дна направляющего отверстия.

■ 4. Сверление глубокого отверстия

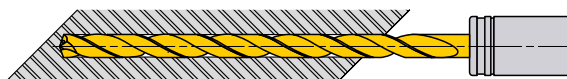

- ① Увеличьте частоту вращения и подачу за цикл и просверлите до желаемой глубины.

■ 5. Проходные отверстия

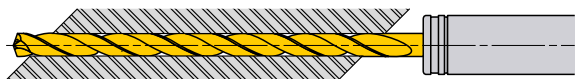

- ① При выходе из заготовки режущая кромка сверла может обломиться.
- ② При выводе сверла в отверстие снизьте скорость подачи.

■ 6. Отвод сверла из отверстия

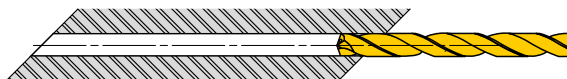

- ① Обработайте отверстие со скоростью резания $20-30 \text{ м/мин}$ и подачей $0,2-0,3 \text{ мм/об}$.
- ② Поднимите сверло из направляющего отверстия до глубины начальной точки с подачей 3000 мм/мин .

ИНСТРУМЕНТ ДЛЯ СВЕРЛЕНИЯ (МОНОЛИТНЫЕ ТВЕРДОСПЛАВНЫЕ СВЕРЛА)

MPS

- Глубина сверления 3-40 L/D.
- Тип MPS с двойной ленточкой для точного и надежного сверления.



Сверхдлинные сверла с четырьмя ленточками



Внутреннее охлаждение

	3 ≤ D1 ≤ 6	6 < D1 ≤ 10	10 < D1 ≤ 18	18 < D1 ≤ 20
DIN Тип	+0.010 -0.002	+0.010 -0.005	+0.005 -0.013	+0.005 -0.016
Прочее	0 -0.012	0 -0.015	0 -0.018	0 -0.021
h6	0 -0.008	0 -0.009	0 -0.011	0 -0.013



● Тип 1 Цилиндрический хвостовик с конической шейкой

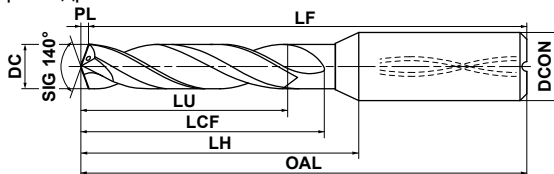

● Тип 2 Цилиндрический хвостовик

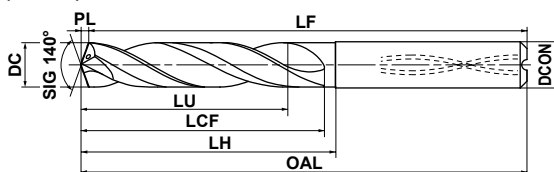

DC (мм)	Глубина сверления (L/D)	VP15TF	Обозначение	Размеры (мм)							Тип	
				LU	LCF	LH	OAL	LF	PL	DCON		
3.0	3	<input type="checkbox"/>	MPS0300S-DIN-C	15.0	19.5	24.5	61.5	61	0.5	6	1	
	5	<input type="checkbox"/>	MPS0300L-DIN-C	23.0	27.5	28.5	65.5	65	0.5	6	1	
	8	<input type="checkbox"/>	MPS0300-L8C	24.5	33.5	36.5	73.5	73	0.5	6	1	
	10	<input type="checkbox"/>	MPS0300-L10C	30.5	39.5	42.5	79.5	79	0.5	6	1	
	12	<input type="checkbox"/>	MPS0300-L12C	36.5	45.5	48.5	85.5	85	0.5	6	1	
	15	<input type="checkbox"/>	MPS0300-L15C	45.5	54.5	57.5	94.5	94	0.5	6	1	
	20	<input type="checkbox"/>	MPS0300-L20C	60.5	69.5	72.5	109.5	109	0.5	6	1	
	25	<input type="checkbox"/>	MPS0300-L25C	75.5	84.5	87.5	124.5	124	0.5	6	1	
	30	<input type="checkbox"/>	MPS0300-L30C	90.5	99.5	102.5	139.5	139	0.5	6	1	
3.05	3	<input type="checkbox"/>	MPS0305S-DIN-C	15.0	19.6	24.6	61.6	61	0.6	6	1	
	5	<input type="checkbox"/>	MPS0305L-DIN-C	23.0	27.6	28.6	65.6	65	0.6	6	1	
	3.1	3	<input type="checkbox"/>	MPS0310S-DIN-C	14.9	19.6	24.6	61.6	61	0.6	6	1
		5	<input type="checkbox"/>	MPS0310L-DIN-C	22.9	27.6	28.6	65.6	65	0.6	6	1
		8	<input type="checkbox"/>	MPS0310-L8C	25.4	39.6	42.6	79.6	79	0.6	6	1
		10	<input type="checkbox"/>	MPS0310-L10C	31.6	46.6	49.6	86.6	86	0.6	6	1
		12	<input type="checkbox"/>	MPS0310-L12C	37.8	53.6	56.6	93.6	93	0.6	6	1
		15	<input type="checkbox"/>	MPS0310-L15C	47.1	63.6	66.6	103.6	103	0.6	6	1
		20	<input type="checkbox"/>	MPS0310-L20C	62.6	81.6	84.6	121.6	121	0.6	6	1
25		<input type="checkbox"/>	MPS0310-L25C	78.1	98.6	101.6	138.6	138	0.6	6	1	
30		<input type="checkbox"/>	MPS0310-L30C	93.6	116.6	119.6	156.6	156	0.6	6	1	
3.2	3	<input type="checkbox"/>	MPS0320S-DIN-C	14.8	19.6	24.6	61.6	61	0.6	6	1	
	5	<input type="checkbox"/>	MPS0320L-DIN-C	22.8	27.6	28.6	65.6	65	0.6	6	1	
	8	<input type="checkbox"/>	MPS0320-L8C	26.2	39.6	42.6	79.6	79	0.6	6	1	
	10	<input type="checkbox"/>	MPS0320-L10C	32.6	46.6	49.6	86.6	86	0.6	6	1	
	12	<input type="checkbox"/>	MPS0320-L12C	39.0	53.6	56.6	93.6	93	0.6	6	1	
	15	<input type="checkbox"/>	MPS0320-L15C	48.6	63.6	66.6	103.6	103	0.6	6	1	
	20	<input type="checkbox"/>	MPS0320-L20C	64.6	81.6	84.6	121.6	121	0.6	6	1	
	25	<input type="checkbox"/>	MPS0320-L25C	80.6	98.6	101.6	138.6	138	0.6	6	1	
	30	<input type="checkbox"/>	MPS0320-L30C	96.6	116.6	119.6	156.6	156	0.6	6	1	
3.5	3	<input type="checkbox"/>	MPS0350S-DIN-C	14.4	19.6	24.6	61.6	61	0.6	6	1	
	5	<input type="checkbox"/>	MPS0350L-DIN-C	22.4	27.6	28.6	65.6	65	0.6	6	1	
	8	<input type="checkbox"/>	MPS0350-L8C	28.6	39.6	42.6	79.6	79	0.6	6	1	
	10	<input type="checkbox"/>	MPS0350-L10C	35.6	46.6	49.6	86.6	86	0.6	6	1	
	12	<input type="checkbox"/>	MPS0350-L12C	42.6	53.6	56.6	93.6	93	0.6	6	1	
	15	<input type="checkbox"/>	MPS0350-L15C	53.1	63.6	66.6	103.6	103	0.6	6	1	
	20	<input type="checkbox"/>	MPS0350-L20C	70.6	81.6	84.6	121.6	121	0.6	6	1	
	25	<input type="checkbox"/>	MPS0350-L25C	88.1	98.6	101.6	138.6	138	0.6	6	1	
	30	<input type="checkbox"/>	MPS0350-L30C	105.6	116.6	119.6	156.6	156	0.6	6	1	

DC (мм)	Глубина сверления (L/D)	VP15TF	Обозначение	Размеры (мм)							Тип
				LU	LCF	LH	OAL	LF	PL	DCON	
3.3	3	<input type="checkbox"/>	MPS0330S-DIN-C	14.7	19.6	24.6	61.6	61	0.6	6	1
	5	<input type="checkbox"/>	MPS0330L-DIN-C	22.7	27.6	28.6	65.6	65	0.6	6	1
	8	<input type="checkbox"/>	MPS0330-L8C	27.0	39.6	42.6	79.6	79	0.6	6	1
	10	<input type="checkbox"/>	MPS0330-L10C	33.6	46.6	49.6	86.6	86	0.6	6	1
	12	<input type="checkbox"/>	MPS0330-L12C	40.2	53.6	56.6	93.6	93	0.6	6	1
	15	<input type="checkbox"/>	MPS0330-L15C	50.1	63.6	66.6	103.6	103	0.6	6	1
	20	<input type="checkbox"/>	MPS0330-L20C	66.6	81.6	84.6	121.6	121	0.6	6	1
	25	<input type="checkbox"/>	MPS0330-L25C	83.1	98.6	101.6	138.6	138	0.6	6	1
	30	<input type="checkbox"/>	MPS0330-L30C	99.6	116.6	119.6	156.6	156	0.6	6	1
3.4	3	<input type="checkbox"/>	MPS0340S-DIN-C	14.5	19.6	24.6	61.6	61	0.6	6	1
	5	<input type="checkbox"/>	MPS0340L-DIN-C	22.5	27.6	28.6	65.6	65	0.6	6	1
	8	<input type="checkbox"/>	MPS0340-L8C	27.8	39.6	42.6	79.6	79	0.6	6	1
	10	<input type="checkbox"/>	MPS0340-L10C	34.6	46.6	49.6	86.6	86	0.6	6	1
	12	<input type="checkbox"/>	MPS0340-L12C	41.4	53.6	56.6	93.6	93	0.6	6	1
	15	<input type="checkbox"/>	MPS0340-L15C	51.6	63.6	66.6	103.6	103	0.6	6	1
	20	<input type="checkbox"/>	MPS0340-L20C	68.6	81.6	84.6	121.6	121	0.6	6	1
	25	<input type="checkbox"/>	MPS0340-L25C	85.6	98.6	101.6	138.6	138	0.6	6	1
	30	<input type="checkbox"/>	MPS0340-L30C	102.6	116.6	119.6	156.6	156	0.6	6	1
3.5	3	<input type="checkbox"/>	MPS0350S-DIN-C	14.4	19.6	24.6	61.6	61	0.6	6	1
	5	<input type="checkbox"/>	MPS0350L-DIN-C	22.4	27.6	28.6	65.6	65	0.6	6	1
	8	<input type="checkbox"/>	MPS0350-L8C	28.6	39.6	42.6	79.6	79	0.6	6	1
	10	<input type="checkbox"/>	MPS0350-L10C	35.6	46.6	49.6	86.6	86	0.6	6	1
	12	<input type="checkbox"/>	MPS0350-L12C	42.6	53.6	56.6	93.6	93	0.6	6	1
	15	<input type="checkbox"/>	MPS0350-L15C	53.1	63.6	66.6	103.6	103	0.6	6	1
	20	<input type="checkbox"/>	MPS0350-L20C	70.6	81.6	84.6	121.6	121	0.6	6	1
	25	<input type="checkbox"/>	MPS0350-L25C	88.1	98.6	101.6	138.6	138	0.6	6	1
	30	<input type="checkbox"/>	MPS0350-L30C	105.6	116.6	119.6	156.6	156	0.6	6	1



Пожалуйста, замените все будущие заказы изделий, отмеченных серым цветом (MPS,MSL), на серию MPS1 с немедленным вступлением в силу. Это связано с тем, что производство MPS, MSL будет постепенно прекращаться и остановится в марте 2023 года.

☐ : Нет на складе, выпускается исключительно под заказ.

DC (мм)	Глубина сверления (L/D)	VP15TF	Обозначение	Размеры (мм)							Тип
				LU	LCF	LH	OAL	LF	PL	DCON	
3.6	3	□	MPS0360S-DIN-C	14.3	19.7	24.7	61.7	61	0.7	6	1
	5	□	MPS0360L-DIN-C	22.3	27.7	28.7	65.7	65	0.7	6	1
	8	□	MPS0360-L8C	29.5	44.7	47.7	84.7	84	0.7	6	1
	10	□	MPS0360-L10C	36.7	52.7	55.7	92.7	92	0.7	6	1
	12	□	MPS0360-L12C	43.9	60.7	63.7	100.7	100	0.7	6	1
	15	□	MPS0360-L15C	54.7	72.7	75.7	112.7	112	0.7	6	1
	20	□	MPS0360-L20C	72.7	92.7	95.7	132.7	132	0.7	6	1
	25	□	MPS0360-L25C	90.7	112.7	115.7	152.7	152	0.7	6	1
	30	□	MPS0360-L30C	108.7	132.7	135.7	172.7	172	0.7	6	1
	35	□	MPS0360-L35C	126.7	145.7	155.7	192.7	192	0.7	6	1
40	□	MPS0360-L40C	144.7	162.7	175.7	212.7	212	0.7	6	1	
3.7	3	□	MPS0370S-DIN-C	14.1	19.7	24.7	61.7	61	0.7	6	1
	5	□	MPS0370L-DIN-C	22.1	27.7	28.7	65.7	65	0.7	6	1
	8	□	MPS0370-L8C	30.3	44.7	47.7	84.7	84	0.7	6	1
	10	□	MPS0370-L10C	37.7	52.7	55.7	92.7	92	0.7	6	1
	12	□	MPS0370-L12C	45.1	60.7	63.7	100.7	100	0.7	6	1
	15	□	MPS0370-L15C	56.2	72.7	75.7	112.7	112	0.7	6	1
	20	□	MPS0370-L20C	74.7	92.7	95.7	132.7	132	0.7	6	1
	25	□	MPS0370-L25C	93.2	112.7	115.7	152.7	152	0.7	6	1
	30	□	MPS0370-L30C	111.7	132.7	135.7	172.7	172	0.7	6	1
	35	□	MPS0370-L35C	130.2	145.7	155.7	192.7	192	0.7	6	1
40	□	MPS0370-L40C	148.7	162.7	175.7	212.7	212	0.7	6	1	
3.8	3	□	MPS0380S-DIN-C	18.0	23.7	28.7	65.7	65	0.7	6	1
	5	□	MPS0380L-DIN-C	30.0	35.7	36.7	73.7	73	0.7	6	1
	8	□	MPS0380-L8C	31.1	44.7	47.7	84.7	84	0.7	6	1
	10	□	MPS0380-L10C	38.7	52.7	55.7	92.7	92	0.7	6	1
	12	□	MPS0380-L12C	46.3	60.7	63.7	100.7	100	0.7	6	1
	15	□	MPS0380-L15C	57.7	72.7	75.7	112.7	112	0.7	6	1
	20	□	MPS0380-L20C	76.7	92.7	95.7	132.7	132	0.7	6	1
	25	□	MPS0380-L25C	95.7	112.7	115.7	152.7	152	0.7	6	1
	30	□	MPS0380-L30C	114.7	132.7	135.7	172.7	172	0.7	6	1
	35	□	MPS0380-L35C	133.7	152.7	155.7	192.7	192	0.7	6	1
40	□	MPS0380-L40C	152.7	172.7	175.7	212.7	212	0.7	6	1	
3.9	3	□	MPS0390S-DIN-C	17.9	23.7	28.7	65.7	65	0.7	6	1
	5	□	MPS0390L-DIN-C	29.9	35.7	36.7	73.7	73	0.7	6	1
	8	□	MPS0390-L8C	31.9	44.7	47.7	84.7	84	0.7	6	1
	10	□	MPS0390-L10C	39.7	52.7	55.7	92.7	92	0.7	6	1
	12	□	MPS0390-L12C	47.5	60.7	63.7	100.7	100	0.7	6	1
	15	□	MPS0390-L15C	59.2	72.7	75.7	112.7	112	0.7	6	1
	20	□	MPS0390-L20C	78.7	92.7	95.7	132.7	132	0.7	6	1
	25	□	MPS0390-L25C	98.2	112.7	115.7	152.7	152	0.7	6	1
	30	□	MPS0390-L30C	117.7	132.7	135.7	172.7	172	0.7	6	1
	35	□	MPS0390-L35C	137.2	152.7	155.7	192.7	192	0.7	6	1
40	□	MPS0390-L40C	156.7	172.7	175.7	212.7	212	0.7	6	1	
4.0	3	□	MPS0400S-DIN-C	17.7	23.7	28.7	65.7	65	0.7	6	1
	5	□	MPS0400L-DIN-C	29.7	35.7	36.7	73.7	73	0.7	6	1
	8	□	MPS0400-L8C	32.7	44.7	47.7	84.7	84	0.7	6	1
	10	□	MPS0400-L10C	40.7	52.7	55.7	92.7	92	0.7	6	1
	12	□	MPS0400-L12C	48.7	60.7	63.7	100.7	100	0.7	6	1
	15	□	MPS0400-L15C	60.7	72.7	75.7	112.7	112	0.7	6	1
	20	□	MPS0400-L20C	80.7	92.7	95.7	132.7	132	0.7	6	1
	25	□	MPS0400-L25C	100.7	112.7	115.7	152.7	152	0.7	6	1
	30	□	MPS0400-L30C	120.7	132.7	135.7	172.7	172	0.7	6	1
	35	□	MPS0400-L35C	140.7	152.7	155.7	192.7	192	0.7	6	1
40	□	MPS0400-L40C	160.7	172.7	175.7	212.7	212	0.7	6	1	

DC (мм)	Глубина сверления (L/D)	VP15TF	Обозначение	Размеры (мм)							Тип
				LU	LCF	LH	OAL	LF	PL	DCON	
4.05	3	□	MPS0405S-DIN-C	17.7	23.7	28.7	65.7	65	0.7	6	1
	5	□	MPS0405L-DIN-C	29.7	35.7	36.7	73.7	73	0.7	6	1
4.1	3	□	MPS0410S-DIN-C	17.6	23.7	28.7	65.7	65	0.7	6	1
	5	□	MPS0410L-DIN-C	29.6	35.7	36.7	73.7	73	0.7	6	1
	8	□	MPS0410-L8C	33.5	50.7	53.7	90.7	90	0.7	6	1
	10	□	MPS0410-L10C	41.7	59.7	62.7	99.7	99	0.7	6	1
	12	□	MPS0410-L12C	49.9	68.7	71.7	108.7	108	0.7	6	1
	15	□	MPS0410-L15C	62.2	81.7	84.7	121.7	121	0.7	6	1
	20	□	MPS0410-L20C	82.7	104.7	107.7	144.7	144	0.7	6	1
	25	□	MPS0410-L25C	103.2	126.7	129.7	166.7	166	0.7	6	1
	30	□	MPS0410-L30C	123.7	149.7	152.7	189.7	189	0.7	6	1
	35	□	MPS0410-L35C	144.2	165.7	174.7	211.7	211	0.7	6	1
40	□	MPS0410-L40C	164.7	185.7	198.7	235.7	235	0.7	6	1	
4.2	3	□	MPS0420S-DIN-C	17.5	23.8	28.8	65.8	65	0.8	6	1
	5	□	MPS0420L-DIN-C	29.5	35.8	36.8	73.8	73	0.8	6	1
	8	□	MPS0420-L8C	34.4	50.8	53.8	90.8	90	0.8	6	1
	10	□	MPS0420-L10C	42.8	59.8	62.8	99.8	99	0.8	6	1
	12	□	MPS0420-L12C	51.2	68.8	71.8	108.8	108	0.8	6	1
	15	□	MPS0420-L15C	63.8	81.8	84.8	121.8	121	0.8	6	1
	20	□	MPS0420-L20C	84.8	104.8	107.8	144.8	144	0.8	6	1
	25	□	MPS0420-L25C	105.8	126.8	129.8	166.8	166	0.8	6	1
	30	□	MPS0420-L30C	126.8	149.8	152.8	189.8	189	0.8	6	1
	35	□	MPS0420-L35C	147.8	165.8	174.8	211.8	211	0.8	6	1
40	□	MPS0420-L40C	168.8	185.8	198.8	235.8	235	0.8	6	1	
4.3	3	□	MPS0430S-DIN-C	17.3	23.8	28.8	65.8	65	0.8	6	1
	5	□	MPS0430L-DIN-C	29.3	35.8	36.8	73.8	73	0.8	6	1
	8	□	MPS0430-L8C	35.2	50.8	53.8	90.8	90	0.8	6	1
	10	□	MPS0430-L10C	43.8	59.8	62.8	99.8	99	0.8	6	1
	12	□	MPS0430-L12C	52.4	68.8	71.8	108.8	108	0.8	6	1
	15	□	MPS0430-L15C	65.3	81.8	84.8	121.8	121	0.8	6	1
	20	□	MPS0430-L20C	86.8	104.8	107.8	144.8	144	0.8	6	1
	25	□	MPS0430-L25C	108.3	126.8	129.8	166.8	166	0.8	6	1
	30	□	MPS0430-L30C	129.8	149.8	152.8	189.8	189	0.8	6	1
	35	□	MPS0430-L35C	151.3	171.8	174.8	211.8	211	0.8	6	1
40	□	MPS0430-L40C	172.8	195.8	198.8	235.8	235	0.8	6	1	
4.4	3	□	MPS0440S-DIN-C	17.2	23.8	28.8	65.8	65	0.8	6	1
	5	□	MPS0440L-DIN-C	29.2	35.8	36.8	73.8	73	0.8	6	1
	8	□	MPS0440-L8C	36.0	50.8	53.8	90.8	90	0.8	6	1
	10	□	MPS0440-L10C	44.8	59.8	62.8	99.8	99	0.8	6	1
	12	□	MPS0440-L12C	53.6	68.8	71.8	108.8	108	0.8	6	1
	15	□	MPS0440-L15C	66.8	81.8	84.8	121.8	121	0.8	6	1
	20	□	MPS0440-L20C	88.8	104.8	107.8	144.8	144	0.8	6	1
	25	□	MPS0440-L25C	110.8	126.8	129.8	166.8	166	0.8	6	1
	30	□	MPS0440-L30C	132.8	149.8	152.8	189.8	189	0.8	6	1
	35	□	MPS0440-L35C	154.8	171.8	174.8	211.8	211	0.8	6	1
40	□	MPS0440-L40C	176.8	195.8	198.8	235.8	235	0.8	6	1	
4.5	3	□	MPS0450S-DIN-C	17.1	23.8	28.8	65.8	65	0.8	6	1
	5	□	MPS0450L-DIN-C	29.1	35.8	36.8	73.8	73	0.8	6	1
	8	□	MPS0450-L8C	36.8	50.8	53.8	90.8	90	0.8	6	1
	10	□	MPS0450-L10C	45.8	59.8	62.8	99.8	99	0.8	6	1
	12	□	MPS0450-L12C	54.8	68.8	71.8	108.8	108	0.8	6	1
	15	□	MPS0450-L15C	68.3	81.8	84.8	121.8	121	0.8	6	1
	20	□	MPS0450-L20C	90.8	104.8	107.8	144.8	144	0.8	6	1
	25	□	MPS0450-L25C	113.3	126.8	129.8	166.8	166	0.8	6	1
	30	□	MPS0450-L30C	135.8	149.8	152.8	189.8	189	0.8	6	1
	35	□	MPS0450-L35C	158.3	171.8	174.8	211.8	211	0.8	6	1
40	□	MPS0450-L40C	180.8	195.8	198.8	235.8	235	0.8	6	1	

ИНСТРУМЕНТ ДЛЯ СВЕРЛЕНИЯ (МОНОЛИТНЫЕ ТВЕРДОСПЛАВНЫЕ СВЕРЛА)

MPS

Свердлинные сверла с четырьмя ленточками

ТВЕРДЫЙ
СПЛАВ

M

ИНСТРУМЕНТ ДЛЯ
СВЕРЛЕНИЯ

DC (мм)	Глубина сверления (L/D)	VP15TF	Обозначение	Размеры (мм)							Тип
				LU	LCF	LH	OAL	LF	PL	DCON	
4.6	3	<input type="checkbox"/>	MPS0460S-DIN-C	16.9	23.8	28.8	65.8	65	0.8	6	1
	5	<input type="checkbox"/>	MPS0460L-DIN-C	28.9	35.8	36.8	73.8	73	0.8	6	1
	8	<input type="checkbox"/>	MPS0460-L8C	37.6	55.8	58.8	95.8	95	0.8	6	1
	10	<input type="checkbox"/>	MPS0460-L10C	46.8	65.8	68.8	105.8	105	0.8	6	1
	12	<input type="checkbox"/>	MPS0460-L12C	56.0	75.8	78.8	115.8	115	0.8	6	1
	15	<input type="checkbox"/>	MPS0460-L15C	69.8	90.8	93.8	130.8	130	0.8	6	1
	20	<input type="checkbox"/>	MPS0460-L20C	92.8	115.8	118.8	155.8	155	0.8	6	1
	25	<input type="checkbox"/>	MPS0460-L25C	115.8	140.8	143.8	180.8	180	0.8	6	1
	30	<input type="checkbox"/>	MPS0460-L30C	138.8	165.8	168.8	205.8	205	0.8	6	1
	35	<input type="checkbox"/>	MPS0460-L35C	161.8	184.8	192.8	229.8	229	0.8	6	1
40	<input type="checkbox"/>	MPS0460-L40C	184.8	204.8	217.8	254.8	254	0.8	6	1	
4.65	3	<input type="checkbox"/>	MPS0465S-DIN-C	16.9	23.8	28.8	65.8	65	0.8	6	1
	5	<input type="checkbox"/>	MPS0465L-DIN-C	28.9	35.8	36.8	73.8	73	0.8	6	1
4.7	3	<input type="checkbox"/>	MPS0470S-DIN-C	16.8	23.9	28.9	65.9	65	0.9	6	1
	5	<input type="checkbox"/>	MPS0470L-DIN-C	28.8	35.9	36.9	73.9	73	0.9	6	1
	8	<input type="checkbox"/>	MPS0470-L8C	38.5	55.9	58.9	95.9	95	0.9	6	1
	10	<input type="checkbox"/>	MPS0470-L10C	47.9	65.9	68.9	105.9	105	0.9	6	1
	12	<input type="checkbox"/>	MPS0470-L12C	57.3	75.9	78.9	115.9	115	0.9	6	1
	15	<input type="checkbox"/>	MPS0470-L15C	71.4	90.9	93.9	130.9	130	0.9	6	1
	20	<input type="checkbox"/>	MPS0470-L20C	94.9	115.9	118.9	155.9	155	0.9	6	1
	25	<input type="checkbox"/>	MPS0470-L25C	118.4	140.9	143.9	180.9	180	0.9	6	1
	30	<input type="checkbox"/>	MPS0470-L30C	141.9	165.9	168.9	205.9	205	0.9	6	1
	35	<input type="checkbox"/>	MPS0470-L35C	165.4	184.9	192.9	229.9	229	0.9	6	1
40	<input type="checkbox"/>	MPS0470-L40C	188.9	204.9	217.9	254.9	254	0.9	6	1	
4.8	3	<input type="checkbox"/>	MPS0480S-DIN-C	20.7	27.9	28.9	65.9	65	0.9	6	1
	5	<input type="checkbox"/>	MPS0480L-DIN-C	36.7	43.9	44.9	81.9	81	0.9	6	1
	8	<input type="checkbox"/>	MPS0480-L8C	39.3	55.9	58.9	95.9	95	0.9	6	1
	10	<input type="checkbox"/>	MPS0480-L10C	48.9	65.9	68.9	105.9	105	0.9	6	1
	12	<input type="checkbox"/>	MPS0480-L12C	58.5	75.9	78.9	115.9	115	0.9	6	1
	15	<input type="checkbox"/>	MPS0480-L15C	72.9	90.9	93.9	130.9	130	0.9	6	1
	20	<input type="checkbox"/>	MPS0480-L20C	96.9	115.9	118.9	155.9	155	0.9	6	1
	25	<input type="checkbox"/>	MPS0480-L25C	120.9	140.9	143.9	180.9	180	0.9	6	1
	30	<input type="checkbox"/>	MPS0480-L30C	144.9	165.9	168.9	205.9	205	0.9	6	1
	35	<input type="checkbox"/>	MPS0480-L35C	168.9	190.9	192.9	229.9	229	0.9	6	1
40	<input type="checkbox"/>	MPS0480-L40C	192.9	215.9	217.9	254.9	254	0.9	6	1	
4.9	3	<input type="checkbox"/>	MPS0490S-DIN-C	20.5	27.9	28.9	65.9	65	0.9	6	1
	5	<input type="checkbox"/>	MPS0490L-DIN-C	36.5	43.9	44.9	81.9	81	0.9	6	1
	8	<input type="checkbox"/>	MPS0490-L8C	40.1	55.9	58.9	95.9	95	0.9	6	1
	10	<input type="checkbox"/>	MPS0490-L10C	49.9	65.9	68.9	105.9	105	0.9	6	1
	12	<input type="checkbox"/>	MPS0490-L12C	59.7	75.9	78.9	115.9	115	0.9	6	1
	15	<input type="checkbox"/>	MPS0490-L15C	74.4	90.9	93.9	130.9	130	0.9	6	1
	20	<input type="checkbox"/>	MPS0490-L20C	98.9	115.9	118.9	155.9	155	0.9	6	1
	25	<input type="checkbox"/>	MPS0490-L25C	123.4	140.9	143.9	180.9	180	0.9	6	1
	30	<input type="checkbox"/>	MPS0490-L30C	147.9	165.9	168.9	205.9	205	0.9	6	1
	35	<input type="checkbox"/>	MPS0490-L35C	172.4	190.9	192.9	229.9	229	0.9	6	1
40	<input type="checkbox"/>	MPS0490-L40C	196.9	215.9	217.9	254.9	254	0.9	6	1	
5.0	3	<input type="checkbox"/>	MPS0500S-DIN-C	20.4	27.9	28.9	65.9	65	0.9	6	1
	5	<input type="checkbox"/>	MPS0500L-DIN-C	36.4	43.9	44.9	81.9	81	0.9	6	1
	8	<input type="checkbox"/>	MPS0500-L8C	40.9	55.9	58.9	95.9	95	0.9	6	1
	10	<input type="checkbox"/>	MPS0500-L10C	50.9	65.9	68.9	105.9	105	0.9	6	1
	12	<input type="checkbox"/>	MPS0500-L12C	60.9	75.9	78.9	115.9	115	0.9	6	1
	15	<input type="checkbox"/>	MPS0500-L15C	75.9	90.9	93.9	130.9	130	0.9	6	1
	20	<input type="checkbox"/>	MPS0500-L20C	100.9	115.9	118.9	155.9	155	0.9	6	1
	25	<input type="checkbox"/>	MPS0500-L25C	125.9	140.9	143.9	180.9	180	0.9	6	1
	30	<input type="checkbox"/>	MPS0500-L30C	150.9	165.9	168.9	205.9	205	0.9	6	1
	35	<input type="checkbox"/>	MPS0500-L35C	175.9	190.9	192.9	229.9	229	0.9	6	1
40	<input type="checkbox"/>	MPS0500-L40C	200.9	215.9	217.9	254.9	254	0.9	6	1	

DC (мм)	Глубина сверления (L/D)	VP15TF	Обозначение	Размеры (мм)							Тип
				LU	LCF	LH	OAL	LF	PL	DCON	
5.05	3	<input type="checkbox"/>	MPS0505S-DIN-C	20.3	27.9	28.9	65.9	65	0.9	6	1
	5	<input type="checkbox"/>	MPS0505L-DIN-C	36.3	43.9	44.9	81.9	81	0.9	6	1
5.1	3	<input type="checkbox"/>	MPS0510S-DIN-C	20.3	27.9	28.9	65.9	65	0.9	6	1
	5	<input type="checkbox"/>	MPS0510L-DIN-C	36.3	43.9	44.9	81.9	81	0.9	6	1
	8	<input type="checkbox"/>	MPS0510-L8C	41.7	61.9	64.9	101.9	101	0.9	6	1
	10	<input type="checkbox"/>	MPS0510-L10C	51.9	72.9	75.9	112.9	112	0.9	6	1
	12	<input type="checkbox"/>	MPS0510-L12C	62.1	83.9	86.9	123.9	123	0.9	6	1
	15	<input type="checkbox"/>	MPS0510-L15C	77.4	99.9	102.9	139.9	139	0.9	6	1
	20	<input type="checkbox"/>	MPS0510-L20C	102.9	127.9	130.9	167.9	167	0.9	6	1
	25	<input type="checkbox"/>	MPS0510-L25C	128.4	154.9	157.9	194.9	194	0.9	6	1
	30	<input type="checkbox"/>	MPS0510-L30C	153.9	182.9	185.9	222.9	222	0.9	6	1
	35	<input type="checkbox"/>	MPS0510-L35C	179.4	203.9	211.9	248.9	248	0.9	6	1
40	<input type="checkbox"/>	MPS0510-L40C	204.9	230.9	241.9	278.9	278	0.9	6	1	
5.2	3	<input type="checkbox"/>	MPS0520S-DIN-C	20.1	27.9	28.9	65.9	65	0.9	6	1
	5	<input type="checkbox"/>	MPS0520L-DIN-C	36.1	43.9	44.9	81.9	81	0.9	6	1
	8	<input type="checkbox"/>	MPS0520-L8C	42.5	61.9	64.9	101.9	101	0.9	6	1
	10	<input type="checkbox"/>	MPS0520-L10C	52.9	72.9	75.9	112.9	112	0.9	6	1
	12	<input type="checkbox"/>	MPS0520-L12C	63.3	83.9	86.9	123.9	123	0.9	6	1
	15	<input type="checkbox"/>	MPS0520-L15C	78.9	99.9	102.9	139.9	139	0.9	6	1
	20	<input type="checkbox"/>	MPS0520-L20C	104.9	127.9	130.9	167.9	167	0.9	6	1
	25	<input type="checkbox"/>	MPS0520-L25C	130.9	154.9	157.9	194.9	194	0.9	6	1
	30	<input type="checkbox"/>	MPS0520-L30C	156.9	182.9	185.9	222.9	222	0.9	6	1
	35	<input type="checkbox"/>	MPS0520-L35C	182.9	203.9	211.9	248.9	248	0.9	6	1
40	<input type="checkbox"/>	MPS0520-L40C	208.9	230.9	241.9	278.9	278	0.9	6	1	
5.3	3	<input type="checkbox"/>	MPS0530S-DIN-C	20.0	28.0	29.0	66.0	65	1.0	6	1
	5	<input type="checkbox"/>	MPS0530L-DIN-C	36.0	44.0	45.0	82.0	81	1.0	6	1
	8	<input type="checkbox"/>	MPS0530-L8C	43.4	62.0	65.0	102.0	101	1.0	6	1
	10	<input type="checkbox"/>	MPS0530-L10C	54.0	73.0	76.0	113.0	112	1.0	6	1
	12	<input type="checkbox"/>	MPS0530-L12C	64.6	84.0	87.0	124.0	123	1.0	6	1
	15	<input type="checkbox"/>	MPS0530-L15C	80.5	100.0	103.0	140.0	139	1.0	6	1
	20	<input type="checkbox"/>	MPS0530-L20C	107.0	128.0	131.0	168.0	167	1.0	6	1
	25	<input type="checkbox"/>	MPS0530-L25C	133.5	155.0	158.0	195.0	194	1.0	6	1
	30	<input type="checkbox"/>	MPS0530-L30C	160.0	183.0	186.0	223.0	222	1.0	6	1
	35	<input type="checkbox"/>	MPS0530-L35C	186.5	210.0	212.0	249.0	248	1.0	6	1
40	<input type="checkbox"/>	MPS0530-L40C	213.0	241.0	242.0	279.0	278	1.0	6	1	
5.4	3	<input type="checkbox"/>	MPS0540S-DIN-C	19.9	28.0	29.0	66.0	65	1.0	6	1
	5	<input type="checkbox"/>	MPS0540L-DIN-C	35.9	44.0	45.0	82.0	81	1.0	6	1
	8	<input type="checkbox"/>	MPS0540-L8C	44.2	62.0	65.0	102.0	101	1.0	6	1
	10	<input type="checkbox"/>	MPS0540-L10C	55.0	73.0	76.0	113.0	112	1.0	6	1
	12	<input type="checkbox"/>	MPS0540-L12C	65.8	84.0	87.0	124.0	123	1.0	6	1
	15	<input type="checkbox"/>	MPS0540-L15C	82.0	100.0	103.0	140.0	139	1.0	6	1
	20	<input type="checkbox"/>	MPS0540-L20C	109.0	128.0	131.0	168.0	167	1.0	6	1
	25	<input type="checkbox"/>	MPS0540-L25C	136.0	155.0	158.0	195.0	194	1.0	6	1
	30	<input type="checkbox"/>	MPS0540-L30C	163.0	183.0	186.0	223.0	222	1.0	6	1
	35	<input type="checkbox"/>	MPS0540-L35C	190.0	210.0	212.0	249.0	248	1.0	6	1
40	<input type="checkbox"/>	MPS0540-L40C	217.0	241.0	242.0	279.0	278	1.0	6	1	
5.5	3	<input type="checkbox"/>	MPS0550S-DIN-C	19.8	28.0	29.0	66.0	65	1.0	6	1
	5	<input type="checkbox"/>	MPS0550L-DIN-C	35.8	44.0	45.0	82.0	81	1.0	6	1
	8	<input type="checkbox"/>	MPS0550-L8C	45.0	62.0	65.0	102.0	101	1.0	6	1
	10	<input type="checkbox"/>	MPS0550-L10C	56.0	73.0	76.0	113.0	112	1.0	6	1
	12	<input type="checkbox"/>	MPS0550-L12C	67.0	84.0	87.0	124.0	123	1.0	6	1
	15	<input type="checkbox"/>	MPS0550-L15C	83.5	100.0	103.0	140.0	139	1.0	6	1
	20	<input type="checkbox"/>	MPS0550-L20C	111.0	128.0	131.0	168.0	167	1.0	6	1
	25	<input type="checkbox"/>	MPS0550-L25C	138.5	155.0	158.0	195.0	194	1.0	6	1
	30	<input type="checkbox"/>	MPS0550-L30C	166.0	183.0	186.0	223.0	222	1.0	6	1
	35	<input type="checkbox"/>	MPS0550-L35C	193.5	210.0	212.0	249.0	248	1.0	6	1
40	<input type="checkbox"/>	MPS0550-L40C	221.0	241.0	242.0	279.0	278	1.0	6	1	

: Нет на складе, выпускается исключительно под заказ.

DC (мм)	Глубина сверления (L/D)	VP15TF	Обозначение	Размеры (мм)							Тип
				LU	LCF	LH	OAL	LF	PL	DCON	
5.55	3	<input type="checkbox"/>	MPS0555S-DIN-C	19.7	28.0	29.0	66.0	65	1.0	6	1
	5	<input type="checkbox"/>	MPS0555L-DIN-C	35.7	44.0	45.0	82.0	81	1.0	6	1
5.6	3	<input type="checkbox"/>	MPS0560S-DIN-C	19.6	28.0	29.0	66.0	65	1.0	6	1
	5	<input type="checkbox"/>	MPS0560L-DIN-C	35.6	44.0	45.0	82.0	81	1.0	6	1
	8	<input type="checkbox"/>	MPS0560-L8C	45.8	67.0	70.0	107.0	106	1.0	6	1
	10	<input type="checkbox"/>	MPS0560-L10C	57.0	79.0	82.0	119.0	118	1.0	6	1
	12	<input type="checkbox"/>	MPS0560-L12C	68.2	91.0	94.0	131.0	130	1.0	6	1
	15	<input type="checkbox"/>	MPS0560-L15C	85.0	109.0	112.0	149.0	148	1.0	6	1
	20	<input type="checkbox"/>	MPS0560-L20C	113.0	139.0	142.0	179.0	178	1.0	6	1
	25	<input type="checkbox"/>	MPS0560-L25C	141.0	169.0	172.0	209.0	208	1.0	6	1
	30	<input type="checkbox"/>	MPS0560-L30C	169.0	199.0	202.0	239.0	238	1.0	6	1
	35	<input type="checkbox"/>	MPS0560-L35C	197.0	223.0	231.0	268.0	267	1.0	6	1
40	<input type="checkbox"/>	MPS0560-L40C	225.0	251.0	262.0	299.0	298	1.0	6	1	
5.7	3	<input type="checkbox"/>	MPS0570S-DIN-C	19.5	28.0	29.0	66.0	65	1.0	6	1
	5	<input type="checkbox"/>	MPS0570L-DIN-C	35.5	44.0	45.0	82.0	81	1.0	6	1
	8	<input type="checkbox"/>	MPS0570-L8C	46.6	67.0	70.0	107.0	106	1.0	6	1
	10	<input type="checkbox"/>	MPS0570-L10C	58.0	79.0	82.0	119.0	118	1.0	6	1
	12	<input type="checkbox"/>	MPS0570-L12C	69.4	91.0	94.0	131.0	130	1.0	6	1
	15	<input type="checkbox"/>	MPS0570-L15C	86.5	109.0	112.0	149.0	148	1.0	6	1
	20	<input type="checkbox"/>	MPS0570-L20C	115.0	139.0	142.0	179.0	178	1.0	6	1
	25	<input type="checkbox"/>	MPS0570-L25C	143.5	169.0	172.0	209.0	208	1.0	6	1
	30	<input type="checkbox"/>	MPS0570-L30C	172.0	199.0	202.0	239.0	238	1.0	6	1
	35	<input type="checkbox"/>	MPS0570-L35C	200.5	223.0	231.0	268.0	267	1.0	6	1
40	<input type="checkbox"/>	MPS0570-L40C	229.0	251.0	262.0	299.0	298	1.0	6	1	
5.8	3	<input type="checkbox"/>	MPS0580S-DIN-C	19.4	28.1	29.1	66.1	65	1.1	6	1
	5	<input type="checkbox"/>	MPS0580L-DIN-C	35.4	44.1	45.1	82.1	81	1.1	6	1
	8	<input type="checkbox"/>	MPS0580-L8C	47.5	67.1	70.1	107.1	106	1.1	6	1
	10	<input type="checkbox"/>	MPS0580-L10C	59.1	79.1	82.1	119.1	118	1.1	6	1
	12	<input type="checkbox"/>	MPS0580-L12C	70.7	91.1	94.1	131.1	130	1.1	6	1
	15	<input type="checkbox"/>	MPS0580-L15C	88.1	109.1	112.1	149.1	148	1.1	6	1
	20	<input type="checkbox"/>	MPS0580-L20C	117.1	139.1	142.1	179.1	178	1.1	6	1
	25	<input type="checkbox"/>	MPS0580-L25C	146.1	169.1	172.1	209.1	208	1.1	6	1
	30	<input type="checkbox"/>	MPS0580-L30C	175.1	199.1	202.1	239.1	238	1.1	6	1
	35	<input type="checkbox"/>	MPS0580-L35C	204.1	229.1	231.1	268.1	267	1.1	6	1
40	<input type="checkbox"/>	MPS0580-L40C	233.1	261.1	262.1	299.1	298	1.1	6	1	
5.9	3	<input type="checkbox"/>	MPS0590S-DIN-C	19.2	28.1	29.1	66.1	65	1.1	6	1
	5	<input type="checkbox"/>	MPS0590L-DIN-C	35.2	44.1	45.1	82.1	81	1.1	6	1
	8	<input type="checkbox"/>	MPS0590-L8C	48.3	67.1	70.1	107.1	106	1.1	6	1
	10	<input type="checkbox"/>	MPS0590-L10C	60.1	79.1	82.1	119.1	118	1.1	6	1
	12	<input type="checkbox"/>	MPS0590-L12C	71.9	91.1	94.1	131.1	130	1.1	6	1
	15	<input type="checkbox"/>	MPS0590-L15C	89.6	109.1	112.1	149.1	148	1.1	6	1
	20	<input type="checkbox"/>	MPS0590-L20C	119.1	139.1	142.1	179.1	178	1.1	6	1
	25	<input type="checkbox"/>	MPS0590-L25C	148.6	169.1	172.1	209.1	208	1.1	6	1
	30	<input type="checkbox"/>	MPS0590-L30C	178.1	199.1	202.1	239.1	238	1.1	6	1
	35	<input type="checkbox"/>	MPS0590-L35C	207.6	229.1	231.1	268.1	267	1.1	6	1
40	<input type="checkbox"/>	MPS0590-L40C	237.1	261.1	262.1	299.1	298	1.1	6	1	
6.0	3	<input type="checkbox"/>	MPS0600S-DIN-C	19.1	28.1	29.1	66.1	65	1.1	6	2
	5	<input type="checkbox"/>	MPS0600L-DIN-C	35.1	44.1	45.1	82.1	81	1.1	6	2
	8	<input type="checkbox"/>	MPS0600-L8C	49.1	67.1	70.1	107.1	106	1.1	6	2
	10	<input type="checkbox"/>	MPS0600-L10C	61.1	79.1	82.1	119.1	118	1.1	6	2
	12	<input type="checkbox"/>	MPS0600-L12C	73.1	91.1	94.1	131.1	130	1.1	6	2
	15	<input type="checkbox"/>	MPS0600-L15C	91.1	109.1	112.1	149.1	148	1.1	6	2
	20	<input type="checkbox"/>	MPS0600-L20C	121.1	139.1	142.1	179.1	178	1.1	6	2
	25	<input type="checkbox"/>	MPS0600-L25C	151.1	169.1	172.1	209.1	208	1.1	6	2
	30	<input type="checkbox"/>	MPS0600-L30C	181.1	199.1	202.1	239.1	238	1.1	6	2
	35	<input type="checkbox"/>	MPS0600-L35C	211.1	229.1	231.1	268.1	267	1.1	6	2
40	<input type="checkbox"/>	MPS0600-L40C	241.1	261.1	262.1	299.1	298	1.1	6	2	

DC (мм)	Глубина сверления (L/D)	VP15TF	Обозначение	Размеры (мм)							Тип
				LU	LCF	LH	OAL	LF	PL	DCON	
6.05	3	<input type="checkbox"/>	MPS0605S-DIN-C	25.0	34.1	42.1	79.1	78	1.1	8	1
	5	<input type="checkbox"/>	MPS0605L-DIN-C	44.0	53.1	54.1	91.1	90	1.1	8	1
6.1	3	<input type="checkbox"/>	MPS0610S-DIN-C	25.0	34.1	42.1	79.1	78	1.1	8	1
	5	<input type="checkbox"/>	MPS0610L-DIN-C	44.0	53.1	54.1	91.1	90	1.1	8	1
	8	<input type="checkbox"/>	MPS0610-L8C	49.9	73.1	76.1	113.1	112	1.1	8	1
	10	<input type="checkbox"/>	MPS0610-L10C	62.1	86.1	89.1	126.1	125	1.1	8	1
	12	<input type="checkbox"/>	MPS0610-L12C	74.3	99.1	102.1	139.1	138	1.1	8	1
	15	<input type="checkbox"/>	MPS0610-L15C	92.6	118.1	121.1	158.1	157	1.1	8	1
	20	<input type="checkbox"/>	MPS0610-L20C	123.1	151.1	154.1	191.1	190	1.1	8	1
	25	<input type="checkbox"/>	MPS0610-L25C	153.6	183.1	186.1	223.1	222	1.1	8	1
	30	<input type="checkbox"/>	MPS0610-L30C	184.1	216.1	219.1	256.1	255	1.1	8	1
	35	<input type="checkbox"/>	MPS0610-L35C	214.6	241.1	250.1	287.1	286	1.1	8	1
40	<input type="checkbox"/>	MPS0610-L40C	245.1	271.1	284.1	321.1	320	1.1	8	1	
6.2	3	<input type="checkbox"/>	MPS0620S-DIN-C	24.8	34.1	42.1	79.1	78	1.1	8	1
	5	<input type="checkbox"/>	MPS0620L-DIN-C	43.8	53.1	54.1	91.1	90	1.1	8	1
	8	<input type="checkbox"/>	MPS0620-L8C	50.7	73.1	76.1	113.1	112	1.1	8	1
	10	<input type="checkbox"/>	MPS0620-L10C	63.1	86.1	89.1	126.1	125	1.1	8	1
	12	<input type="checkbox"/>	MPS0620-L12C	75.5	99.1	102.1	139.1	138	1.1	8	1
	15	<input type="checkbox"/>	MPS0620-L15C	94.1	118.1	121.1	158.1	157	1.1	8	1
	20	<input type="checkbox"/>	MPS0620-L20C	125.1	151.1	154.1	191.1	190	1.1	8	1
	25	<input type="checkbox"/>	MPS0620-L25C	156.1	183.1	186.1	223.1	222	1.1	8	1
	30	<input type="checkbox"/>	MPS0620-L30C	187.1	216.1	219.1	256.1	255	1.1	8	1
	35	<input type="checkbox"/>	MPS0620-L35C	218.1	241.1	250.1	287.1	286	1.1	8	1
40	<input type="checkbox"/>	MPS0620-L40C	249.1	271.1	284.1	321.1	320	1.1	8	1	
6.3	3	<input type="checkbox"/>	MPS0630S-DIN-C	24.7	34.1	42.1	79.1	78	1.1	8	1
	5	<input type="checkbox"/>	MPS0630L-DIN-C	43.7	53.1	54.1	91.1	90	1.1	8	1
	8	<input type="checkbox"/>	MPS0630-L8C	51.5	73.1	76.1	113.1	112	1.1	8	1
	10	<input type="checkbox"/>	MPS0630-L10C	64.1	86.1	89.1	126.1	125	1.1	8	1
	12	<input type="checkbox"/>	MPS0630-L12C	76.7	99.1	102.1	139.1	138	1.1	8	1
	15	<input type="checkbox"/>	MPS0630-L15C	95.6	118.1	121.1	158.1	157	1.1	8	1
	20	<input type="checkbox"/>	MPS0630-L20C	127.1	151.1	154.1	191.1	190	1.1	8	1
	25	<input type="checkbox"/>	MPS0630-L25C	158.6	183.1	186.1	223.1	222	1.1	8	1
	30	<input type="checkbox"/>	MPS0630-L30C	190.1	216.1	219.1	256.1	255	1.1	8	1
	35	<input type="checkbox"/>	MPS0630-L35C	221.6	248.1	250.1	287.1	286	1.1	8	1
40	<input type="checkbox"/>	MPS0630-L40C	253.1	281.1	284.1	321.1	320	1.1	8	1	
6.4	3	<input type="checkbox"/>	MPS0640S-DIN-C	24.6	34.2	42.2	79.2	78	1.2	8	1
	5	<input type="checkbox"/>	MPS0640L-DIN-C	43.6	53.2	54.2	91.2	90	1.2	8	1
	8	<input type="checkbox"/>	MPS0640-L8C	52.4	73.2	76.2	113.2	112	1.2	8	1
	10	<input type="checkbox"/>	MPS0640-L10C	65.2	86.2	89.2	126.2	125	1.2	8	1
	12	<input type="checkbox"/>	MPS0640-L12C	78.0	99.2	102.2	139.2	138	1.2	8	1
	15	<input type="checkbox"/>	MPS0640-L15C	97.2	118.2	121.2	158.2	157	1.2	8	1
	20	<input type="checkbox"/>	MPS0640-L20C	129.2	151.2	154.2	191.2	190	1.2	8	1
	25	<input type="checkbox"/>	MPS0640-L25C	161.2	183.2	186.2	223.2	222	1.2	8	1
	30	<input type="checkbox"/>	MPS0640-L30C	193.2	216.2	219.2	256.2	255	1.2	8	1
	35	<input type="checkbox"/>	MPS0640-L35C	225.2	248.2	250.2	287.2	286	1.2	8	1
40	<input type="checkbox"/>	MPS0640-L40C	257.2	281.2	284.2	321.2	320	1.2	8	1	

ИНСТРУМЕНТ ДЛЯ СВЕРЛЕНИЯ (МОНОЛИТНЫЕ ТВЕРДОСПЛАВНЫЕ СВЕРЛА)

MPS

Сверхдлинные сверла с четырьмя ленточками

ТВЕРДЫЙ
СПЛАВ

M

ИНСТРУМЕНТ ДЛЯ
СВЕРЛЕНИЯ

DC (мм)	Глубина сверления (L/D)	VP15TF	Обозначение	Размеры (мм)								Тип
				LU	LCF	LH	OAL	LF	PL	DCON		
6.6	3	<input type="checkbox"/>	MPS0660S-DIN-C	24.3	34.2	42.2	79.2	78	1.2	8	1	
	5	<input type="checkbox"/>	MPS0660L-DIN-C	43.3	53.2	54.2	91.2	90	1.2	8	1	
	8	<input type="checkbox"/>	MPS0660-L8C	54.0	78.2	81.2	118.2	117	1.2	8	1	
	10	<input type="checkbox"/>	MPS0660-L10C	67.2	92.2	95.2	132.2	131	1.2	8	1	
	12	<input type="checkbox"/>	MPS0660-L12C	80.4	106.2	109.2	146.2	145	1.2	8	1	
	15	<input type="checkbox"/>	MPS0660-L15C	100.2	127.2	130.2	167.2	166	1.2	8	1	
	20	<input type="checkbox"/>	MPS0660-L20C	133.2	162.2	165.2	202.2	201	1.2	8	1	
	25	<input type="checkbox"/>	MPS0660-L25C	166.2	197.2	200.2	237.2	236	1.2	8	1	
	30	<input type="checkbox"/>	MPS0660-L30C	199.2	232.2	235.2	272.2	271	1.2	8	1	
	35	<input type="checkbox"/>	MPS0660-L35C	232.2	267.2	269.2	306.2	305	1.2	8	1	
40	<input type="checkbox"/>	MPS0660-L40C	265.2	301.2	304.2	341.2	340	1.2	8	1		
6.7	3	<input type="checkbox"/>	MPS0670S-DIN-C	24.2	34.2	42.2	79.2	78	1.2	8	1	
	5	<input type="checkbox"/>	MPS0670L-DIN-C	43.2	53.2	54.2	91.2	90	1.2	8	1	
	8	<input type="checkbox"/>	MPS0670-L8C	54.8	78.2	81.2	118.2	117	1.2	8	1	
	10	<input type="checkbox"/>	MPS0670-L10C	68.2	92.2	95.2	132.2	131	1.2	8	1	
	12	<input type="checkbox"/>	MPS0670-L12C	81.6	106.2	109.2	146.2	145	1.2	8	1	
	15	<input type="checkbox"/>	MPS0670-L15C	101.7	127.2	130.2	167.2	166	1.2	8	1	
	20	<input type="checkbox"/>	MPS0670-L20C	135.2	162.2	165.2	202.2	201	1.2	8	1	
	25	<input type="checkbox"/>	MPS0670-L25C	168.7	197.2	200.2	237.2	236	1.2	8	1	
	30	<input type="checkbox"/>	MPS0670-L30C	202.2	232.2	235.2	272.2	271	1.2	8	1	
	35	<input type="checkbox"/>	MPS0670-L35C	235.7	267.2	269.2	306.2	305	1.2	8	1	
40	<input type="checkbox"/>	MPS0670-L40C	269.2	301.2	304.2	341.2	340	1.2	8	1		
6.8	3	<input type="checkbox"/>	MPS0680S-DIN-C	24.0	34.2	42.2	79.2	78	1.2	8	1	
	5	<input type="checkbox"/>	MPS0680L-DIN-C	43.0	53.2	54.2	91.2	90	1.2	8	1	
	8	<input type="checkbox"/>	MPS0680-L8C	55.6	78.2	81.2	118.2	117	1.2	8	1	
	10	<input type="checkbox"/>	MPS0680-L10C	69.2	92.2	95.2	132.2	131	1.2	8	1	
	12	<input type="checkbox"/>	MPS0680-L12C	82.8	106.2	109.2	146.2	145	1.2	8	1	
	15	<input type="checkbox"/>	MPS0680-L15C	103.2	127.2	130.2	167.2	166	1.2	8	1	
	20	<input type="checkbox"/>	MPS0680-L20C	137.2	162.2	165.2	202.2	201	1.2	8	1	
	25	<input type="checkbox"/>	MPS0680-L25C	171.2	197.2	200.2	237.2	236	1.2	8	1	
	30	<input type="checkbox"/>	MPS0680-L30C	205.2	232.2	235.2	272.2	271	1.2	8	1	
	35	<input type="checkbox"/>	MPS0680-L35C	239.2	267.2	269.2	306.2	305	1.2	8	1	
40	<input type="checkbox"/>	MPS0680-L40C	273.2	301.2	304.2	341.2	340	1.2	8	1		
6.9	3	<input type="checkbox"/>	MPS0690S-DIN-C	23.9	34.3	42.3	79.3	78	1.3	8	1	
	5	<input type="checkbox"/>	MPS0690L-DIN-C	42.9	53.3	54.3	91.3	90	1.3	8	1	
	8	<input type="checkbox"/>	MPS0690-L8C	56.5	78.3	81.3	118.3	117	1.3	8	1	
	10	<input type="checkbox"/>	MPS0690-L10C	70.3	92.3	95.3	132.3	131	1.3	8	1	
	12	<input type="checkbox"/>	MPS0690-L12C	84.1	106.3	109.3	146.3	145	1.3	8	1	
	15	<input type="checkbox"/>	MPS0690-L15C	104.8	127.3	130.3	167.3	166	1.3	8	1	
	20	<input type="checkbox"/>	MPS0690-L20C	139.3	162.3	165.3	202.3	201	1.3	8	1	
	25	<input type="checkbox"/>	MPS0690-L25C	173.8	197.3	200.3	237.3	236	1.3	8	1	
	30	<input type="checkbox"/>	MPS0690-L30C	208.3	232.3	235.3	272.3	271	1.3	8	1	
	35	<input type="checkbox"/>	MPS0690-L35C	242.8	267.3	269.3	306.3	305	1.3	8	1	
40	<input type="checkbox"/>	MPS0690-L40C	277.3	301.3	304.3	341.3	340	1.3	8	1		
7.0	3	<input type="checkbox"/>	MPS0700S-DIN-C	23.8	34.3	42.3	79.3	78	1.3	8	1	
	5	<input type="checkbox"/>	MPS0700L-DIN-C	42.8	53.3	54.3	91.3	90	1.3	8	1	
	8	<input type="checkbox"/>	MPS0700-L8C	57.3	78.3	81.3	118.3	117	1.3	8	1	
	10	<input type="checkbox"/>	MPS0700-L10C	71.3	92.3	95.3	132.3	131	1.3	8	1	
	12	<input type="checkbox"/>	MPS0700-L12C	85.3	106.3	109.3	146.3	145	1.3	8	1	
	15	<input type="checkbox"/>	MPS0700-L15C	106.3	127.3	130.3	167.3	166	1.3	8	1	
	20	<input type="checkbox"/>	MPS0700-L20C	141.3	162.3	165.3	202.3	201	1.3	8	1	
	25	<input type="checkbox"/>	MPS0700-L25C	176.3	197.3	200.3	237.3	236	1.3	8	1	
	30	<input type="checkbox"/>	MPS0700-L30C	211.3	232.3	235.3	272.3	271	1.3	8	1	
	35	<input type="checkbox"/>	MPS0700-L35C	246.3	267.3	269.3	306.3	305	1.3	8	1	
40	<input type="checkbox"/>	MPS0700-L40C	281.3	301.3	304.3	341.3	340	1.3	8	1		

DC (мм)	Глубина сверления (L/D)	VP15TF	Обозначение	Размеры (мм)								Тип
				LU	LCF	LH	OAL	LF	PL	DCON		
7.1	3	<input type="checkbox"/>	MPS0710S-DIN-C	30.6	41.3	42.3	79.3	78	1.3	8	1	
	5	<input type="checkbox"/>	MPS0710L-DIN-C	42.6	53.3	54.3	91.3	90	1.3	8	1	
	8	<input type="checkbox"/>	MPS0710-L8C	58.1	84.3	87.3	124.3	123	1.3	8	1	
	10	<input type="checkbox"/>	MPS0710-L10C	72.3	99.3	102.3	139.3	138	1.3	8	1	
	12	<input type="checkbox"/>	MPS0710-L12C	86.5	114.3	117.3	154.3	153	1.3	8	1	
	15	<input type="checkbox"/>	MPS0710-L15C	107.8	136.3	139.3	176.3	175	1.3	8	1	
	20	<input type="checkbox"/>	MPS0710-L20C	143.3	174.3	177.3	214.3	213	1.3	8	1	
	25	<input type="checkbox"/>	MPS0710-L25C	178.8	211.3	214.3	251.3	250	1.3	8	1	
	30	<input type="checkbox"/>	MPS0710-L30C	214.3	249.3	252.3	289.3	288	1.3	8	1	
	35	<input type="checkbox"/>	MPS0710-L35C	249.8	286.3	288.3	325.3	324	1.3	8	1	
40	<input type="checkbox"/>	MPS0710-L40C	285.3	321.3	323.3	360.3	359	1.3	8	1		
7.2	3	<input type="checkbox"/>	MPS0720S-DIN-C	30.5	41.3	42.3	79.3	78	1.3	8	1	
	5	<input type="checkbox"/>	MPS0720L-DIN-C	42.5	53.3	54.3	91.3	90	1.3	8	1	
	8	<input type="checkbox"/>	MPS0720-L8C	58.9	84.3	87.3	124.3	123	1.3	8	1	
	10	<input type="checkbox"/>	MPS0720-L10C	73.3	99.3	102.3	139.3	138	1.3	8	1	
	12	<input type="checkbox"/>	MPS0720-L12C	87.7	114.3	117.3	154.3	153	1.3	8	1	
	15	<input type="checkbox"/>	MPS0720-L15C	109.3	136.3	139.3	176.3	175	1.3	8	1	
	20	<input type="checkbox"/>	MPS0720-L20C	145.3	174.3	177.3	214.3	213	1.3	8	1	
	25	<input type="checkbox"/>	MPS0720-L25C	181.3	211.3	214.3	251.3	250	1.3	8	1	
	30	<input type="checkbox"/>	MPS0720-L30C	217.3	249.3	252.3	289.3	288	1.3	8	1	
	35	<input type="checkbox"/>	MPS0720-L35C	253.3	286.3	288.3	325.3	324	1.3	8	1	
40	<input type="checkbox"/>	MPS0720-L40C	289.3	321.3	323.3	360.3	359	1.3	8	1		
7.3	3	<input type="checkbox"/>	MPS0730S-DIN-C	30.4	41.3	42.3	79.3	78	1.3	8	1	
	5	<input type="checkbox"/>	MPS0730L-DIN-C	42.4	53.3	54.3	91.3	90	1.3	8	1	
	8	<input type="checkbox"/>	MPS0730-L8C	59.7	84.3	87.3	124.3	123	1.3	8	1	
	10	<input type="checkbox"/>	MPS0730-L10C	74.3	99.3	102.3	139.3	138	1.3	8	1	
	12	<input type="checkbox"/>	MPS0730-L12C	88.9	114.3	117.3	154.3	153	1.3	8	1	
	15	<input type="checkbox"/>	MPS0730-L15C	110.8	136.3	139.3	176.3	175	1.3	8	1	
	20	<input type="checkbox"/>	MPS0730-L20C	147.3	174.3	177.3	214.3	213	1.3	8	1	
	25	<input type="checkbox"/>	MPS0730-L25C	183.8	211.3	214.3	251.3	250	1.3	8	1	
	30	<input type="checkbox"/>	MPS0730-L30C	220.3	249.3	252.3	289.3	288	1.3	8	1	
	35	<input type="checkbox"/>	MPS0730-L35C	256.8	286.3	288.3	325.3	324	1.3	8	1	
40	<input type="checkbox"/>	MPS0730-L40C	293.3	321.3	323.3	360.3	359	1.3	8	1		
7.4	3	<input type="checkbox"/>	MPS0740S-DIN-C	30.2	41.3	42.3	79.3	78	1.3	8	1	
	5	<input type="checkbox"/>	MPS0740L-DIN-C	42.2	53.3	54.3	91.3	90	1.3	8	1	
	8	<input type="checkbox"/>	MPS0740-L8C	60.5	84.3	87.3	124.3	123	1.3	8	1	
	10	<input type="checkbox"/>	MPS0740-L10C	75.3	99.3	102.3	139.3	138	1.3	8	1	
	12	<input type="checkbox"/>	MPS0740-L12C	90.1	114.3	117.3	154.3	153	1.3	8	1	
	15	<input type="checkbox"/>	MPS0740-L15C	112.3	136.3	139.3	176.3	175	1.3	8	1	
	20	<input type="checkbox"/>	MPS0740-L20C	149.3	174.3	177.3	214.3	213	1.3	8	1	
	25	<input type="checkbox"/>	MPS0740-L25C	186.3	211.3	214.3	251.3	250	1.3	8	1	
	30	<input type="checkbox"/>	MPS0740-L30C	223.3	249.3	252.3	289.3	288	1.3	8	1	
	35	<input type="checkbox"/>	MPS0740-L35C	260.3	286.3	288.3	325.3	324	1.3	8	1	
40	<input type="checkbox"/>	MPS0740-L40C	297.3	321.3	323.3	360.3	359	1.3	8	1		
7.5	3	<input type="checkbox"/>	MPS0750S-DIN-C	30.1	41.4	42.4	79.4	78	1.4	8	1	
	5	<input type="checkbox"/>	MPS0750L-DIN-C	42.1	53.4	54.4	91.4	90	1.4	8	1	
	8	<input type="checkbox"/>	MPS0750-L8C	61.4	84.4	87.4	124.4	123	1.4	8	1	
	10	<input type="checkbox"/>	MPS0750-L10C	76.4	99.4	102.4	139.4	138	1.4	8	1	
	12	<input type="checkbox"/>	MPS0750-L12C	91.4	114.4	117.4	154.4	153	1.4	8	1	
	15	<input type="checkbox"/>	MPS0750-L15C	113.9	136.4	139.4	176.4	175	1.4	8	1	
	20	<input type="checkbox"/>	MPS0750-L20C	151.4	174.4	177.4	214.4	213	1.4	8	1	
	25	<input type="checkbox"/>	MPS0750-L25C	188.9	211.4	214.4	251.4	250	1.4	8	1	
	30	<input type="checkbox"/>	MPS0750-L30C	226.4	249.4	252.4	289.4	288	1.4	8	1	
	35	<input type="checkbox"/>	MPS0750-L35C	263.9	286.4	288.4	325.4	324	1.4	8	1	
40	<input type="checkbox"/>	MPS0750-L40C	301.4	321.4	323.4	360.4	359	1.4	8	1		

: Нет на складе, выпускается исключительно под заказ.

DC (мм)	Глубина сверления (L/D)	VP15TF	Обозначение	Размеры (мм)							Тип
				LU	LCF	LH	OAL	LF	PL	DCON	
7.6	3	<input type="checkbox"/>	MPS0760S-DIN-C	30.0	41.4	42.4	79.4	78	1.4	8	1
	5	<input type="checkbox"/>	MPS0760L-DIN-C	42.0	53.4	54.4	91.4	90	1.4	8	1
	8	<input type="checkbox"/>	MPS0760-L8C	62.2	89.4	92.4	129.4	128	1.4	8	1
	10	<input type="checkbox"/>	MPS0760-L10C	77.4	105.4	108.4	145.4	144	1.4	8	1
	12	<input type="checkbox"/>	MPS0760-L12C	92.6	121.4	124.4	161.4	160	1.4	8	1
	15	<input type="checkbox"/>	MPS0760-L15C	115.4	145.4	148.4	185.4	184	1.4	8	1
	20	<input type="checkbox"/>	MPS0760-L20C	153.4	185.4	188.4	225.4	224	1.4	8	1
	25	<input type="checkbox"/>	MPS0760-L25C	191.4	225.4	228.4	265.4	264	1.4	8	1
	30	<input type="checkbox"/>	MPS0760-L30C	229.4	265.4	268.4	305.4	304	1.4	8	1
	35	<input type="checkbox"/>	MPS0760-L35C	267.4	305.4	307.4	344.4	343	1.4	8	1
40	<input type="checkbox"/>	MPS0760-L40C	305.4	341.4	342.4	379.4	378	1.4	8	1	
7.7	3	<input type="checkbox"/>	MPS0770S-DIN-C	29.9	41.4	42.4	79.4	78	1.4	8	1
	5	<input type="checkbox"/>	MPS0770L-DIN-C	41.9	53.4	54.4	91.4	90	1.4	8	1
	8	<input type="checkbox"/>	MPS0770-L8C	63.0	89.4	92.4	129.4	128	1.4	8	1
	10	<input type="checkbox"/>	MPS0770-L10C	78.4	105.4	108.4	145.4	144	1.4	8	1
	12	<input type="checkbox"/>	MPS0770-L12C	93.8	121.4	124.4	161.4	160	1.4	8	1
	15	<input type="checkbox"/>	MPS0770-L15C	116.9	145.4	148.4	185.4	184	1.4	8	1
	20	<input type="checkbox"/>	MPS0770-L20C	155.4	185.4	188.4	225.4	224	1.4	8	1
	25	<input type="checkbox"/>	MPS0770-L25C	193.9	225.4	228.4	265.4	264	1.4	8	1
	30	<input type="checkbox"/>	MPS0770-L30C	232.4	265.4	268.4	305.4	304	1.4	8	1
	35	<input type="checkbox"/>	MPS0770-L35C	270.9	305.4	307.4	344.4	343	1.4	8	1
40	<input type="checkbox"/>	MPS0770-L40C	309.4	341.4	342.4	379.4	378	1.4	8	1	
7.8	3	<input type="checkbox"/>	MPS0780S-DIN-C	29.7	41.4	42.4	79.4	78	1.4	8	1
	5	<input type="checkbox"/>	MPS0780L-DIN-C	41.7	53.4	54.4	91.4	90	1.4	8	1
	8	<input type="checkbox"/>	MPS0780-L8C	63.8	89.4	92.4	129.4	128	1.4	8	1
	10	<input type="checkbox"/>	MPS0780-L10C	79.4	105.4	108.4	145.4	144	1.4	8	1
	12	<input type="checkbox"/>	MPS0780-L12C	95.0	121.4	124.4	161.4	160	1.4	8	1
	15	<input type="checkbox"/>	MPS0780-L15C	118.4	145.4	148.4	185.4	184	1.4	8	1
	20	<input type="checkbox"/>	MPS0780-L20C	157.4	185.4	188.4	225.4	224	1.4	8	1
	25	<input type="checkbox"/>	MPS0780-L25C	196.4	225.4	228.4	265.4	264	1.4	8	1
	30	<input type="checkbox"/>	MPS0780-L30C	235.4	265.4	268.4	305.4	304	1.4	8	1
	35	<input type="checkbox"/>	MPS0780-L35C	274.4	305.4	307.4	344.4	343	1.4	8	1
40	<input type="checkbox"/>	MPS0780-L40C	313.4	341.4	342.4	379.4	378	1.4	8	1	
7.9	3	<input type="checkbox"/>	MPS0790S-DIN-C	29.6	41.4	42.4	79.4	78	1.4	8	1
	5	<input type="checkbox"/>	MPS0790L-DIN-C	41.6	53.4	54.4	91.4	90	1.4	8	1
	8	<input type="checkbox"/>	MPS0790-L8C	64.6	89.4	92.4	129.4	128	1.4	8	1
	10	<input type="checkbox"/>	MPS0790-L10C	80.4	105.4	108.4	145.4	144	1.4	8	1
	12	<input type="checkbox"/>	MPS0790-L12C	96.2	121.4	124.4	161.4	160	1.4	8	1
	15	<input type="checkbox"/>	MPS0790-L15C	119.9	145.4	148.4	185.4	184	1.4	8	1
	20	<input type="checkbox"/>	MPS0790-L20C	159.4	185.4	188.4	225.4	224	1.4	8	1
	25	<input type="checkbox"/>	MPS0790-L25C	198.9	225.4	228.4	265.4	264	1.4	8	1
	30	<input type="checkbox"/>	MPS0790-L30C	238.4	265.4	268.4	305.4	304	1.4	8	1
	35	<input type="checkbox"/>	MPS0790-L35C	277.9	305.4	307.4	344.4	343	1.4	8	1
40	<input type="checkbox"/>	MPS0790-L40C	317.4	341.4	342.4	379.4	378	1.4	8	1	
8.0	3	<input type="checkbox"/>	MPS0800S-DIN-C	29.5	41.5	42.5	79.5	78	1.5	8	2
	5	<input type="checkbox"/>	MPS0800L-DIN-C	41.5	53.5	54.5	91.5	90	1.5	8	2
	8	<input type="checkbox"/>	MPS0800-L8C	65.5	89.5	92.5	129.5	128	1.5	8	2
	10	<input type="checkbox"/>	MPS0800-L10C	81.5	105.5	108.5	145.5	144	1.5	8	2
	12	<input type="checkbox"/>	MPS0800-L12C	97.5	121.5	124.5	161.5	160	1.5	8	2
	15	<input type="checkbox"/>	MPS0800-L15C	121.5	145.5	148.5	185.5	184	1.5	8	2
	20	<input type="checkbox"/>	MPS0800-L20C	161.5	185.5	188.5	225.5	224	1.5	8	2
	25	<input type="checkbox"/>	MPS0800-L25C	201.5	225.5	228.5	265.5	264	1.5	8	2
	30	<input type="checkbox"/>	MPS0800-L30C	241.5	265.5	268.5	305.5	304	1.5	8	2
	35	<input type="checkbox"/>	MPS0800-L35C	281.5	305.5	307.5	344.5	343	1.5	8	2
40	<input type="checkbox"/>	MPS0800-L40C	321.5	341.5	342.5	379.5	378	1.5	8	2	

DC (мм)	Глубина сверления (L/D)	VP15TF	Обозначение	Размеры (мм)							Тип
				LU	LCF	LH	OAL	LF	PL	DCON	
8.05	3	<input type="checkbox"/>	MPS0805S-DIN-C	34.4	46.5	47.5	88.5	87	1.5	10	1
	5	<input type="checkbox"/>	MPS0805L-DIN-C	48.4	60.5	61.5	102.5	101	1.5	10	1
8.1	3	<input type="checkbox"/>	MPS0810S-DIN-C	34.3	46.5	47.5	88.5	87	1.5	10	1
	5	<input type="checkbox"/>	MPS0810L-DIN-C	48.3	60.5	61.5	102.5	101	1.5	10	1
	8	<input type="checkbox"/>	MPS0810-L8C	66.3	95.5	98.5	139.5	138	1.5	10	1
	10	<input type="checkbox"/>	MPS0810-L10C	82.5	112.5	115.5	156.5	155	1.5	10	1
	12	<input type="checkbox"/>	MPS0810-L12C	98.7	129.5	132.5	173.5	172	1.5	10	1
	15	<input type="checkbox"/>	MPS0810-L15C	123.0	154.5	157.5	198.5	197	1.5	10	1
	20	<input type="checkbox"/>	MPS0810-L20C	163.5	197.5	200.5	241.5	240	1.5	10	1
	25	<input type="checkbox"/>	MPS0810-L25C	204.0	239.5	242.5	283.5	282	1.5	10	1
	30	<input type="checkbox"/>	MPS0810-L30C	244.5	281.5	284.5	325.5	324	1.5	10	1
	35	<input type="checkbox"/>	MPS0810-L35C	285.0	324.5	326.5	367.5	366	1.5	10	1
40	<input type="checkbox"/>	MPS0810-L40C	325.5	366.5	370.5	411.5	410	1.5	10	1	
8.2	3	<input type="checkbox"/>	MPS0820S-DIN-C	34.2	46.5	47.5	88.5	87	1.5	10	1
	5	<input type="checkbox"/>	MPS0820L-DIN-C	48.2	60.5	61.5	102.5	101	1.5	10	1
	8	<input type="checkbox"/>	MPS0820-L8C	67.1	95.5	98.5	139.5	138	1.5	10	1
	10	<input type="checkbox"/>	MPS0820-L10C	83.5	112.5	115.5	156.5	155	1.5	10	1
	12	<input type="checkbox"/>	MPS0820-L12C	99.9	129.5	132.5	173.5	172	1.5	10	1
	15	<input type="checkbox"/>	MPS0820-L15C	124.5	154.5	157.5	198.5	197	1.5	10	1
	20	<input type="checkbox"/>	MPS0820-L20C	165.5	197.5	200.5	241.5	240	1.5	10	1
	25	<input type="checkbox"/>	MPS0820-L25C	206.5	239.5	242.5	283.5	282	1.5	10	1
	30	<input type="checkbox"/>	MPS0820-L30C	247.5	281.5	284.5	325.5	324	1.5	10	1
	35	<input type="checkbox"/>	MPS0820-L35C	288.5	324.5	326.5	367.5	366	1.5	10	1
40	<input type="checkbox"/>	MPS0820-L40C	329.5	366.5	370.5	411.5	410	1.5	10	1	
8.3	3	<input type="checkbox"/>	MPS0830S-DIN-C	34.1	46.5	47.5	88.5	87	1.5	10	1
	5	<input type="checkbox"/>	MPS0830L-DIN-C	48.1	60.5	61.5	102.5	101	1.5	10	1
	8	<input type="checkbox"/>	MPS0830-L8C	67.9	95.5	98.5	139.5	138	1.5	10	1
	10	<input type="checkbox"/>	MPS0830-L10C	84.5	112.5	115.5	156.5	155	1.5	10	1
	12	<input type="checkbox"/>	MPS0830-L12C	101.1	129.5	132.5	173.5	172	1.5	10	1
	15	<input type="checkbox"/>	MPS0830-L15C	126.0	154.5	157.5	198.5	197	1.5	10	1
	20	<input type="checkbox"/>	MPS0830-L20C	167.5	197.5	200.5	241.5	240	1.5	10	1
	25	<input type="checkbox"/>	MPS0830-L25C	209.0	239.5	242.5	283.5	282	1.5	10	1
	30	<input type="checkbox"/>	MPS0830-L30C	250.5	281.5	284.5	325.5	324	1.5	10	1
	35	<input type="checkbox"/>	MPS0830-L35C	292.0	324.5	326.5	367.5	366	1.5	10	1
40	<input type="checkbox"/>	MPS0830-L40C	333.5	366.5	370.5	411.5	410	1.5	10	1	
8.4	3	<input type="checkbox"/>	MPS0840S-DIN-C	33.9	46.5	47.5	88.5	87	1.5	10	1
	5	<input type="checkbox"/>	MPS0840L-DIN-C	47.9	60.5	61.5	102.5	101	1.5	10	1
	8	<input type="checkbox"/>	MPS0840-L8C	68.7	95.5	98.5	139.5	138	1.5	10	1
	10	<input type="checkbox"/>	MPS0840-L10C	85.5	112.5	115.5	156.5	155	1.5	10	1
	12	<input type="checkbox"/>	MPS0840-L12C	102.3	129.5	132.5	173.5	172	1.5	10	1
	15	<input type="checkbox"/>	MPS0840-L15C	127.5	154.5	157.5	198.5	197	1.5	10	1
	20	<input type="checkbox"/>	MPS0840-L20C	169.5	197.5	200.5	241.5	240	1.5	10	1
	25	<input type="checkbox"/>	MPS0840-L25C	211.5	239.5	242.5	283.5	282	1.5	10	1
	30	<input type="checkbox"/>	MPS0840-L30C	253.5	281.5	284.5	325.5	324	1.5	10	1
	35	<input type="checkbox"/>	MPS0840-L35C	295.5	324.5	326.5	367.5	366	1.5	10	1
40	<input type="checkbox"/>	MPS0840-L40C	337.5	366.5	370.5	411.5	410	1.5	10	1	
8.5	3	<input type="checkbox"/>	MPS0850S-DIN-C	33.8	46.5	47.5	88.5	87	1.5	10	1
	5	<input type="checkbox"/>	MPS0850L-DIN-C	47.8	60.5	61.5	102.5	101	1.5	10	1
	8	<input type="checkbox"/>	MPS0850-L8C	69.5	95.5	98.5	139.5	138	1.5	10	1
	10	<input type="checkbox"/>	MPS0850-L10C	86.5	112.5	115.5	156.5	155	1.5	10	1
	12	<input type="checkbox"/>	MPS0850-L12C	103.5	129.5	132.5	173.5	172	1.5	10	1
	15	<input type="checkbox"/>	MPS0850-L15C	129.0	154.5	157.5	198.5	197	1.5	10	1
	20	<input type="checkbox"/>	MPS0850-L20C	171.5	197.5	200.5	241.5	240	1.5	10	1
	25	<input type="checkbox"/>	MPS0850-L25C	214.0	239.5	242.5	283.5	282	1.5	10	1
	30	<input type="checkbox"/>	MPS0850-L30C	256.5	281.5	284.5	325.5	324	1.5	10	1
	35	<input type="checkbox"/>	MPS0850-L35C	299.0	324.5	326.5	367.5	366	1.5	10	1
40	<input type="checkbox"/>	MPS0850-L40C	341.5	366.5	370.5	411.5	410	1.5	10	1	

ИНСТРУМЕНТ ДЛЯ СВЕРЛЕНИЯ (МОНОЛИТНЫЕ ТВЕРДОСПЛАВНЫЕ СВЕРЛА)

MPS

Сверхдлинные сверла с четырьмя ленточками

ТВЕРДЫЙ
СПЛАВ

M

ИНСТРУМЕНТ ДЛЯ
СВЕРЛЕНИЯ

DC (мм)	Глубина сверления (L/D)	VP15TF	Обозначение	Размеры (мм)							Тип
				LU	LCF	LH	OAL	LF	PL	DCON	
8.6	3	<input type="checkbox"/>	MPS0860S-DIN-C	33.7	46.6	47.6	88.6	87	1.6	10	1
	5	<input type="checkbox"/>	MPS0860L-DIN-C	47.7	60.6	61.6	102.6	101	1.6	10	1
	8	<input type="checkbox"/>	MPS0860-L8C	70.4	100.6	103.6	144.6	143	1.6	10	1
	10	<input type="checkbox"/>	MPS0860-L10C	87.6	118.6	121.6	162.6	161	1.6	10	1
	12	<input type="checkbox"/>	MPS0860-L12C	104.8	136.6	139.6	180.6	179	1.6	10	1
	15	<input type="checkbox"/>	MPS0860-L15C	130.6	163.6	166.6	207.6	206	1.6	10	1
	20	<input type="checkbox"/>	MPS0860-L20C	173.6	208.6	211.6	252.6	251	1.6	10	1
	25	<input type="checkbox"/>	MPS0860-L25C	216.6	253.6	256.6	297.6	296	1.6	10	1
	30	<input type="checkbox"/>	MPS0860-L30C	259.6	297.6	300.6	341.6	340	1.6	10	1
	35	<input type="checkbox"/>	MPS0860-L35C	302.6	343.6	345.6	386.6	385	1.6	10	1
40	<input type="checkbox"/>	MPS0860-L40C	345.6	391.6	394.6	435.6	434	1.6	10	1	
8.7	3	<input type="checkbox"/>	MPS0870S-DIN-C	33.5	46.6	47.6	88.6	87	1.6	10	1
	5	<input type="checkbox"/>	MPS0870L-DIN-C	47.5	60.6	61.6	102.6	101	1.6	10	1
	8	<input type="checkbox"/>	MPS0870-L8C	71.2	100.6	103.6	144.6	143	1.6	10	1
	10	<input type="checkbox"/>	MPS0870-L10C	88.6	118.6	121.6	162.6	161	1.6	10	1
	12	<input type="checkbox"/>	MPS0870-L12C	106.0	136.6	139.6	180.6	179	1.6	10	1
	15	<input type="checkbox"/>	MPS0870-L15C	132.1	163.6	166.6	207.6	206	1.6	10	1
	20	<input type="checkbox"/>	MPS0870-L20C	175.6	208.6	211.6	252.6	251	1.6	10	1
	25	<input type="checkbox"/>	MPS0870-L25C	219.1	253.6	256.6	297.6	296	1.6	10	1
	30	<input type="checkbox"/>	MPS0870-L30C	262.6	297.6	300.6	341.6	340	1.6	10	1
	35	<input type="checkbox"/>	MPS0870-L35C	306.1	343.6	345.6	386.6	385	1.6	10	1
40	<input type="checkbox"/>	MPS0870-L40C	349.6	391.6	394.6	435.6	434	1.6	10	1	
8.8	3	<input type="checkbox"/>	MPS0880S-DIN-C	33.4	46.6	47.6	88.6	87	1.6	10	1
	5	<input type="checkbox"/>	MPS0880L-DIN-C	47.4	60.6	61.6	102.6	101	1.6	10	1
	8	<input type="checkbox"/>	MPS0880-L8C	72.0	100.6	103.6	144.6	143	1.6	10	1
	10	<input type="checkbox"/>	MPS0880-L10C	89.6	118.6	121.6	162.6	161	1.6	10	1
	12	<input type="checkbox"/>	MPS0880-L12C	107.2	136.6	139.6	180.6	179	1.6	10	1
	15	<input type="checkbox"/>	MPS0880-L15C	133.6	163.6	166.6	207.6	206	1.6	10	1
	20	<input type="checkbox"/>	MPS0880-L20C	177.6	208.6	211.6	252.6	251	1.6	10	1
	25	<input type="checkbox"/>	MPS0880-L25C	221.6	253.6	256.6	297.6	296	1.6	10	1
	30	<input type="checkbox"/>	MPS0880-L30C	265.6	297.6	300.6	341.6	340	1.6	10	1
	35	<input type="checkbox"/>	MPS0880-L35C	309.6	343.6	345.6	386.6	385	1.6	10	1
40	<input type="checkbox"/>	MPS0880-L40C	353.6	391.6	394.6	435.6	434	1.6	10	1	
8.9	3	<input type="checkbox"/>	MPS0890S-DIN-C	33.3	46.6	47.6	88.6	87	1.6	10	1
	5	<input type="checkbox"/>	MPS0890L-DIN-C	47.3	60.6	61.6	102.6	101	1.6	10	1
	8	<input type="checkbox"/>	MPS0890-L8C	72.8	100.6	103.6	144.6	143	1.6	10	1
	10	<input type="checkbox"/>	MPS0890-L10C	90.6	118.6	121.6	162.6	161	1.6	10	1
	12	<input type="checkbox"/>	MPS0890-L12C	108.4	136.6	139.6	180.6	179	1.6	10	1
	15	<input type="checkbox"/>	MPS0890-L15C	135.1	163.6	166.6	207.6	206	1.6	10	1
	20	<input type="checkbox"/>	MPS0890-L20C	179.6	208.6	211.6	252.6	251	1.6	10	1
	25	<input type="checkbox"/>	MPS0890-L25C	224.1	253.6	256.6	297.6	296	1.6	10	1
	30	<input type="checkbox"/>	MPS0890-L30C	268.6	297.6	300.6	341.6	340	1.6	10	1
	35	<input type="checkbox"/>	MPS0890-L35C	313.1	343.6	345.6	386.6	385	1.6	10	1
40	<input type="checkbox"/>	MPS0890-L40C	357.6	391.6	394.6	435.6	434	1.6	10	1	
9.0	3	<input type="checkbox"/>	MPS0900S-DIN-C	33.1	46.6	47.6	88.6	87	1.6	10	1
	5	<input type="checkbox"/>	MPS0900L-DIN-C	47.1	60.6	61.6	102.6	101	1.6	10	1
	8	<input type="checkbox"/>	MPS0900-L8C	73.6	100.6	103.6	144.6	143	1.6	10	1
	10	<input type="checkbox"/>	MPS0900-L10C	91.6	118.6	121.6	162.6	161	1.6	10	1
	12	<input type="checkbox"/>	MPS0900-L12C	109.6	136.6	139.6	180.6	179	1.6	10	1
	15	<input type="checkbox"/>	MPS0900-L15C	136.6	163.6	166.6	207.6	206	1.6	10	1
	20	<input type="checkbox"/>	MPS0900-L20C	181.6	208.6	211.6	252.6	251	1.6	10	1
	25	<input type="checkbox"/>	MPS0900-L25C	226.6	253.6	256.6	297.6	296	1.6	10	1
	30	<input type="checkbox"/>	MPS0900-L30C	271.6	297.6	300.6	341.6	340	1.6	10	1
	35	<input type="checkbox"/>	MPS0900-L35C	316.6	343.6	345.6	386.6	385	1.6	10	1
40	<input type="checkbox"/>	MPS0900-L40C	361.6	391.6	394.6	435.6	434	1.6	10	1	

DC (мм)	Глубина сверления (L/D)	VP15TF	Обозначение	Размеры (мм)							Тип
				LU	LCF	LH	OAL	LF	PL	DCON	
9.1	3	<input type="checkbox"/>	MPS0910S-DIN-C	33.0	46.7	47.7	88.7	87	1.7	10	1
	5	<input type="checkbox"/>	MPS0910L-DIN-C	47.0	60.7	61.7	102.7	101	1.7	10	1
	8	<input type="checkbox"/>	MPS0910-L8C	74.5	106.7	109.7	150.7	149	1.7	10	1
	10	<input type="checkbox"/>	MPS0910-L10C	92.7	125.7	128.7	169.7	168	1.7	10	1
	12	<input type="checkbox"/>	MPS0910-L12C	110.9	144.7	147.7	188.7	187	1.7	10	1
	15	<input type="checkbox"/>	MPS0910-L15C	138.2	172.7	175.7	216.7	215	1.7	10	1
	20	<input type="checkbox"/>	MPS0910-L20C	183.7	220.7	223.7	264.7	263	1.7	10	1
	25	<input type="checkbox"/>	MPS0910-L25C	229.2	267.7	270.7	311.7	310	1.7	10	1
	30	<input type="checkbox"/>	MPS0910-L30C	274.7	315.7	318.7	359.7	358	1.7	10	1
	35	<input type="checkbox"/>	MPS0910-L35C	320.2	362.7	364.7	405.7	404	1.7	10	1
9.2	3	<input type="checkbox"/>	MPS0920S-DIN-C	32.9	46.7	47.7	88.7	87	1.7	10	1
	5	<input type="checkbox"/>	MPS0920L-DIN-C	46.9	60.7	61.7	102.7	101	1.7	10	1
	8	<input type="checkbox"/>	MPS0920-L8C	75.3	106.7	109.7	150.7	149	1.7	10	1
	10	<input type="checkbox"/>	MPS0920-L10C	93.7	125.7	128.7	169.7	168	1.7	10	1
	12	<input type="checkbox"/>	MPS0920-L12C	112.1	144.7	147.7	188.7	187	1.7	10	1
	15	<input type="checkbox"/>	MPS0920-L15C	139.7	172.7	175.7	216.7	215	1.7	10	1
	20	<input type="checkbox"/>	MPS0920-L20C	185.7	220.7	223.7	264.7	263	1.7	10	1
	25	<input type="checkbox"/>	MPS0920-L25C	231.7	267.7	270.7	311.7	310	1.7	10	1
	30	<input type="checkbox"/>	MPS0920-L30C	277.7	315.7	318.7	359.7	358	1.7	10	1
	35	<input type="checkbox"/>	MPS0920-L35C	323.7	362.7	364.7	405.7	404	1.7	10	1
9.3	3	<input type="checkbox"/>	MPS0930S-DIN-C	32.7	46.7	47.7	88.7	87	1.7	10	1
	5	<input type="checkbox"/>	MPS0930L-DIN-C	46.7	60.7	61.7	102.7	101	1.7	10	1
	8	<input type="checkbox"/>	MPS0930-L8C	76.1	106.7	109.7	150.7	149	1.7	10	1
	10	<input type="checkbox"/>	MPS0930-L10C	94.7	125.7	128.7	169.7	168	1.7	10	1
	12	<input type="checkbox"/>	MPS0930-L12C	113.3	144.7	147.7	188.7	187	1.7	10	1
	15	<input type="checkbox"/>	MPS0930-L15C	141.2	172.7	175.7	216.7	215	1.7	10	1
	20	<input type="checkbox"/>	MPS0930-L20C	187.7	220.7	223.7	264.7	263	1.7	10	1
	25	<input type="checkbox"/>	MPS0930-L25C	234.2	267.7	270.7	311.7	310	1.7	10	1
	30	<input type="checkbox"/>	MPS0930-L30C	280.7	315.7	318.7	359.7	358	1.7	10	1
	35	<input type="checkbox"/>	MPS0930-L35C	327.2	362.7	364.7	405.7	404	1.7	10	1
9.4	3	<input type="checkbox"/>	MPS0940S-DIN-C	32.6	46.7	47.7	88.7	87	1.7	10	1
	5	<input type="checkbox"/>	MPS0940L-DIN-C	46.6	60.7	61.7	102.7	101	1.7	10	1
	8	<input type="checkbox"/>	MPS0940-L8C	76.9	106.7	109.7	150.7	149	1.7	10	1
	10	<input type="checkbox"/>	MPS0940-L10C	95.7	125.7	128.7	169.7	168	1.7	10	1
	12	<input type="checkbox"/>	MPS0940-L12C	114.5	144.7	147.7	188.7	187	1.7	10	1
	15	<input type="checkbox"/>	MPS0940-L15C	142.7	172.7	175.7	216.7	215	1.7	10	1
	20	<input type="checkbox"/>	MPS0940-L20C	189.7	220.7	223.7	264.7	263	1.7	10	1
	25	<input type="checkbox"/>	MPS0940-L25C	236.7	267.7	270.7	311.7	310	1.7	10	1
	30	<input type="checkbox"/>	MPS0940-L30C	283.7	315.7	318.7	359.7	358	1.7	10	1
	35	<input type="checkbox"/>	MPS0940-L35C	330.7	362.7	364.7	405.7	404	1.7	10	1
9.5	3	<input type="checkbox"/>	MPS0950S-DIN-C	32.5	46.7	47.7	88.7	87	1.7	10	1
	5	<input type="checkbox"/>	MPS0950L-DIN-C	46.5	60.7	61.7	102.7	101	1.7	10	1
	8	<input type="checkbox"/>	MPS0950-L8C	77.7	106.7	109.7	150.7	149	1.7	10	1
	10	<input type="checkbox"/>	MPS0950-L10C	96.7	125.7	128.7	169.7	168	1.7	10	1
	12	<input type="checkbox"/>	MPS0950-L12C	115.7	144.7	147.7	188.7	187	1.7	10	1
	15	<input type="checkbox"/>	MPS0950-L15C	144.2	172.7	175.7	216.7	215	1.7	10	1
	20	<input type="checkbox"/>	MPS0950-L20C	191.7	220.7	223.7	264.7	263	1.7	10	1
	25	<input type="checkbox"/>	MPS0950-L25C	239.2	267.7	270.7	311.7	310	1.7	10	1
	30	<input type="checkbox"/>	MPS0950-L30C	286.7	315.7	318.7	359.7	358	1.7	10	1
	35	<input type="checkbox"/>	MPS0950-L35C	334.2	362.7	364.7	405.7	404	1.7	10	1
9.6	3	<input type="checkbox"/>	MPS0960S-DIN-C	32.3	46.7	47.7	88.7	87	1.7	10	1
	5	<input type="checkbox"/>	MPS0960L-DIN-C	46.3	60.7	61.7	102.7	101	1.7	10	1
	8	<input type="checkbox"/>	MPS0960-L8C	78.5	111.7	114.7	155.7	154	1.7	10	1
	10	<input type="checkbox"/>	MPS0960-L10C	97.7	131.7	134.7	175.7	174	1.7	10	1
	12	<input type="checkbox"/>	MPS0960-L12C	116.9	151.7	154.7	195.7	194	1.7	10	1
	15	<input type="checkbox"/>	MPS0960-L15C	145.7	181.7	184.7	225.7	224	1.7	10	1

: Нет на складе, выпускается исключительно под заказ.

DC (мм)	Глубина сверления (L/D)	VP15TF	Обозначение	Размеры (мм)							Тип
				LU	LCF	LH	OAL	LF	PL	DCON	
9.6	20	□	MPS0960-L20C	193.7	231.7	234.7	275.7	274	1.7	10	1
	25	□	MPS0960-L25C	241.7	281.7	284.7	325.7	324	1.7	10	1
	30	□	MPS0960-L30C	289.7	331.7	334.7	375.7	374	1.7	10	1
	35	□	MPS0960-L35C	337.7	381.7	383.7	424.7	423	1.7	10	1
9.7	3	□	MPS0970S-DIN-C	32.2	46.8	47.8	88.8	87	1.8	10	1
	5	□	MPS0970L-DIN-C	46.2	60.8	61.8	102.8	101	1.8	10	1
	8	□	MPS0970-L8C	79.4	111.8	114.8	155.8	154	1.8	10	1
	10	□	MPS0970-L10C	98.8	131.8	134.8	175.8	174	1.8	10	1
	12	□	MPS0970-L12C	118.2	151.8	154.8	195.8	194	1.8	10	1
	15	□	MPS0970-L15C	147.3	181.8	184.8	225.8	224	1.8	10	1
	20	□	MPS0970-L20C	195.8	231.8	234.8	275.8	274	1.8	10	1
	25	□	MPS0970-L25C	244.3	281.8	284.8	325.8	324	1.8	10	1
	30	□	MPS0970-L30C	292.8	331.8	334.8	375.8	374	1.8	10	1
35	□	MPS0970-L35C	341.3	381.8	383.8	424.8	423	1.8	10	1	
9.8	3	□	MPS0980S-DIN-C	32.1	46.8	47.8	88.8	87	1.8	10	1
	5	□	MPS0980L-DIN-C	46.1	60.8	61.8	102.8	101	1.8	10	1
	8	□	MPS0980-L8C	80.2	111.8	114.8	155.8	154	1.8	10	1
	10	□	MPS0980-L10C	99.8	131.8	134.8	175.8	174	1.8	10	1
	12	□	MPS0980-L12C	119.4	151.8	154.8	195.8	194	1.8	10	1
	15	□	MPS0980-L15C	148.8	181.8	184.8	225.8	224	1.8	10	1
	20	□	MPS0980-L20C	197.8	231.8	234.8	275.8	274	1.8	10	1
	25	□	MPS0980-L25C	246.8	281.8	284.8	325.8	324	1.8	10	1
	30	□	MPS0980-L30C	295.8	331.8	334.8	375.8	374	1.8	10	1
35	□	MPS0980-L35C	344.8	381.8	383.8	424.8	423	1.8	10	1	
9.9	3	□	MPS0990S-DIN-C	32.0	46.8	47.8	88.8	87	1.8	10	1
	5	□	MPS0990L-DIN-C	46.0	60.8	61.8	102.8	101	1.8	10	1
	8	□	MPS0990-L8C	81.0	111.8	114.8	155.8	154	1.8	10	1
	10	□	MPS0990-L10C	100.8	131.8	134.8	175.8	174	1.8	10	1
	12	□	MPS0990-L12C	120.6	151.8	154.8	195.8	194	1.8	10	1
	15	□	MPS0990-L15C	150.3	181.8	184.8	225.8	224	1.8	10	1
	20	□	MPS0990-L20C	199.8	231.8	234.8	275.8	274	1.8	10	1
	25	□	MPS0990-L25C	249.3	281.8	284.8	325.8	324	1.8	10	1
	30	□	MPS0990-L30C	298.8	331.8	334.8	375.8	374	1.8	10	1
35	□	MPS0990-L35C	348.3	381.8	383.8	424.8	423	1.8	10	1	
10.0	3	□	MPS1000S-DIN-C	31.8	46.8	47.8	88.8	87	1.8	10	2
	5	□	MPS1000L-DIN-C	45.8	60.8	61.8	102.8	101	1.8	10	2
	8	□	MPS1000-L8C	81.8	111.8	114.8	155.8	154	1.8	10	2
	10	□	MPS1000-L10C	101.8	131.8	134.8	175.8	174	1.8	10	2
	12	□	MPS1000-L12C	121.8	151.8	154.8	195.8	194	1.8	10	2
	15	□	MPS1000-L15C	151.8	181.8	184.8	225.8	224	1.8	10	2
	20	□	MPS1000-L20C	201.8	231.8	234.8	275.8	274	1.8	10	2
	25	□	MPS1000-L25C	251.8	281.8	284.8	325.8	324	1.8	10	2
	30	□	MPS1000-L30C	301.8	331.8	334.8	375.8	374	1.8	10	2
35	□	MPS1000-L35C	351.8	381.8	383.8	424.8	423	1.8	10	2	
10.05	3	□	MPS1005S-DIN-C	39.8	54.8	55.8	101.8	100	1.8	12	1
	5	□	MPS1005L-DIN-C	55.8	70.8	71.8	117.8	116	1.8	12	1
10.1	3	□	MPS1010S-DIN-C	39.7	54.8	55.8	101.8	100	1.8	12	1
	5	□	MPS1010L-DIN-C	55.7	70.8	71.8	117.8	116	1.8	12	1
	8	□	MPS1010-L8C	82.6	117.8	120.8	166.8	165	1.8	12	1
	10	□	MPS1010-L10C	102.8	138.8	141.8	187.8	186	1.8	12	1
	12	□	MPS1010-L12C	123.0	159.8	162.8	208.8	207	1.8	12	1
	15	□	MPS1010-L15C	153.3	190.8	193.8	239.8	238	1.8	12	1
10.1	20	□	MPS1010-L20C	203.8	243.8	246.8	292.8	291	1.8	12	1
	25	□	MPS1010-L25C	254.3	295.8	298.8	344.8	343	1.8	12	1

DC (мм)	Глубина сверления (L/D)	VP15TF	Обозначение	Размеры (мм)							Тип	
				LU	LCF	LH	OAL	LF	PL	DCON		
10.2	3	□	MPS1020S-DIN-C	39.6	54.9	55.9	101.9	100	1.9	12	1	
	5	□	MPS1020L-DIN-C	55.6	70.9	71.9	117.9	116	1.9	12	1	
	8	□	MPS1020-L8C	83.5	117.9	120.9	166.9	165	1.9	12	1	
	10	□	MPS1020-L10C	103.9	138.9	141.9	187.9	186	1.9	12	1	
	12	□	MPS1020-L12C	124.3	159.9	162.9	208.9	207	1.9	12	1	
	15	□	MPS1020-L15C	154.9	190.9	193.9	239.9	238	1.9	12	1	
	20	□	MPS1020-L20C	205.9	243.9	246.9	292.9	291	1.9	12	1	
25	□	MPS1020-L25C	256.9	295.9	298.9	344.9	343	1.9	12	1		
10.3	3	□	MPS1030S-DIN-C	39.4	54.9	55.9	101.9	100	1.9	12	1	
	5	□	MPS1030L-DIN-C	55.4	70.9	71.9	117.9	116	1.9	12	1	
	8	□	MPS1030-L8C	84.3	117.9	120.9	166.9	165	1.9	12	1	
	10	□	MPS1030-L10C	104.9	138.9	141.9	187.9	186	1.9	12	1	
	12	□	MPS1030-L12C	125.5	159.9	162.9	208.9	207	1.9	12	1	
	15	□	MPS1030-L15C	156.4	190.9	193.9	239.9	238	1.9	12	1	
10.3	20	□	MPS1030-L20C	207.9	243.9	246.9	292.9	291	1.9	12	1	
	25	□	MPS1030-L25C	259.4	295.9	298.9	344.9	343	1.9	12	1	
	10.4	3	□	MPS1040S-DIN-C	39.3	54.9	55.9	101.9	100	1.9	12	1
		5	□	MPS1040L-DIN-C	55.3	70.9	71.9	117.9	116	1.9	12	1
		8	□	MPS1040-L8C	85.1	117.9	120.9	166.9	165	1.9	12	1
10		□	MPS1040-L10C	105.9	138.9	141.9	187.9	186	1.9	12	1	
12		□	MPS1040-L12C	126.7	159.9	162.9	208.9	207	1.9	12	1	
15		□	MPS1040-L15C	157.9	190.9	193.9	239.9	238	1.9	12	1	
20		□	MPS1040-L20C	209.9	243.9	246.9	292.9	291	1.9	12	1	
25	□	MPS1040-L25C	261.9	295.9	298.9	344.9	343	1.9	12	1		
10.5	3	□	MPS1050S-DIN-C	39.2	54.9	55.9	101.9	100	1.9	12	1	
	5	□	MPS1050L-DIN-C	55.2	70.9	71.9	117.9	116	1.9	12	1	
	8	□	MPS1050-L8C	85.9	117.9	120.9	166.9	165	1.9	12	1	
	10	□	MPS1050-L10C	106.9	138.9	141.9	187.9	186	1.9	12	1	
	12	□	MPS1050-L12C	127.9	159.9	162.9	208.9	207	1.9	12	1	
	15	□	MPS1050-L15C	159.4	190.9	193.9	239.9	238	1.9	12	1	
	20	□	MPS1050-L20C	211.9	243.9	246.9	292.9	291	1.9	12	1	
25	□	MPS1050-L25C	264.4	295.9	298.9	344.9	343	1.9	12	1		
10.6	3	□	MPS1060S-DIN-C	39.0	54.9	55.9	101.9	100	1.9	12	1	
	5	□	MPS1060L-DIN-C	55.0	70.9	71.9	117.9	116	1.9	12	1	
	8	□	MPS1060-L8C	86.7	122.9	125.9	171.9	170	1.9	12	1	
	10	□	MPS1060-L10C	107.9	144.9	147.9	193.9	192	1.9	12	1	
	12	□	MPS1060-L12C	129.1	166.9	169.9	215.9	214	1.9	12	1	
	15	□	MPS1060-L15C	160.9	197.9	202.9	248.9	247	1.9	12	1	
	20	□	MPS1060-L20C	213.9	254.9	257.9	303.9	302	1.9	12	1	
25	□	MPS1060-L25C	266.9	309.9	312.9	358.9	357	1.9	12	1		
10.7	3	□	MPS1070S-DIN-C	38.9	54.9	55.9	101.9	100	1.9	12	1	
	5	□	MPS1070L-DIN-C	54.9	70.9	71.9	117.9	116	1.9	12	1	
	8	□	MPS1070-L8C	87.5	122.9	125.9	171.9	170	1.9	12	1	
	10	□	MPS1070-L10C	108.9	144.9	147.9	193.9	192	1.9	12	1	
	12	□	MPS1070-L12C	130.3	166.9	169.9	215.9	214	1.9	12	1	
	15	□	MPS1070-L15C	162.4	197.9	202.9	248.9	247	1.9	12	1	
	20	□	MPS1070-L20C	215.9	254.9	257.9	303.9	302	1.9	12	1	
25	□	MPS1070-L25C	269.4	309.9	312.9	358.9	357	1.9	12	1		
10.8	3	□	MPS1080S-DIN-C	38.8	55.0	56.0	102.0	100	2.0	12	1	
	5	□	MPS1080L-DIN-C	54.8	71.0	72.0	118.0	116	2.0	12	1	
	8	□	MPS1080-L8C	88.4	123.0	126.0	172.0	170	2.0	12	1	
	10	□	MPS1080-L10C	110.0	145.0	148.0	194.0	192	2.0	12	1	
	12	□	MPS1080-L12C	131.6	167.0	170.0	216.0	214	2.0	12	1	
	15	□	MPS1080-L15C	164.0	198.0	203.0	249.0	247	2.0	12	1	
	20	□	MPS1080-L20C	218.0	255.0	258.0	304.0	302	2.0	12	1	
	25	□	MPS1080-L25C	272.0	310.0	313.0	359.0	357	2.0	12	1	

ИНСТРУМЕНТ ДЛЯ СВЕРЛЕНИЯ (МОНОЛИТНЫЕ ТВЕРДОСПЛАВНЫЕ СВЕРЛА)

MPS

Сверхдлинные сверла с четырьмя ленточками

ТВЕРДЫЙ СПЛАВ

М

ИНСТРУМЕНТ ДЛЯ СВЕРЛЕНИЯ

DC (мм)	Глубина сверления (L/D)	VP15TF	Обозначение	Размеры (мм)							Тип
				LU	LCF	LH	OAL	LF	PL	DCON	
10.9	3	<input type="checkbox"/>	MPS1090S-DIN-C	38.6	55.0	56.0	102.0	100	2.0	12	1
	5	<input type="checkbox"/>	MPS1090L-DIN-C	54.6	71.0	72.0	118.0	116	2.0	12	1
	8	<input type="checkbox"/>	MPS1090-L8C	89.2	123.0	126.0	172.0	170	2.0	12	1
	10	<input type="checkbox"/>	MPS1090-L10C	111.0	145.0	148.0	194.0	192	2.0	12	1
	12	<input type="checkbox"/>	MPS1090-L12C	132.8	167.0	170.0	216.0	214	2.0	12	1
	15	<input type="checkbox"/>	MPS1090-L15C	165.5	198.0	203.0	249.0	247	2.0	12	1
	20	<input type="checkbox"/>	MPS1090-L20C	220.0	255.0	258.0	304.0	302	2.0	12	1
25	<input type="checkbox"/>	MPS1090-L25C	274.5	310.0	313.0	359.0	357	2.0	12	1	
11.0	3	<input type="checkbox"/>	MPS1100S-DIN-C	38.5	55.0	56.0	102.0	100	2.0	12	1
	5	<input type="checkbox"/>	MPS1100L-DIN-C	54.5	71.0	72.0	118.0	116	2.0	12	1
	8	<input type="checkbox"/>	MPS1100-L8C	90.0	123.0	126.0	172.0	170	2.0	12	1
	10	<input type="checkbox"/>	MPS1100-L10C	112.0	145.0	148.0	194.0	192	2.0	12	1
	12	<input type="checkbox"/>	MPS1100-L12C	134.0	167.0	170.0	216.0	214	2.0	12	1
	15	<input type="checkbox"/>	MPS1100-L15C	167.0	198.0	203.0	249.0	247	2.0	12	1
	20	<input type="checkbox"/>	MPS1100-L20C	222.0	255.0	258.0	304.0	302	2.0	12	1
25	<input type="checkbox"/>	MPS1100-L25C	277.0	310.0	313.0	359.0	357	2.0	12	1	
11.1	3	<input type="checkbox"/>	MPS1110S-DIN-C	38.4	55.0	56.0	102.0	100	2.0	12	1
	5	<input type="checkbox"/>	MPS1110L-DIN-C	54.4	71.0	72.0	118.0	116	2.0	12	1
	8	<input type="checkbox"/>	MPS1110-L8C	90.8	129.0	132.0	178.0	176	2.0	12	1
	10	<input type="checkbox"/>	MPS1110-L10C	113.0	152.0	155.0	201.0	199	2.0	12	1
	12	<input type="checkbox"/>	MPS1110-L12C	135.2	175.0	178.0	224.0	222	2.0	12	1
	15	<input type="checkbox"/>	MPS1110-L15C	168.5	209.0	212.0	258.0	256	2.0	12	1
	20	<input type="checkbox"/>	MPS1110-L20C	224.0	267.0	270.0	316.0	314	2.0	12	1
25	<input type="checkbox"/>	MPS1110-L25C	279.5	324.0	327.0	373.0	371	2.0	12	1	
11.2	3	<input type="checkbox"/>	MPS1120S-DIN-C	38.2	55.0	56.0	102.0	100	2.0	12	1
	5	<input type="checkbox"/>	MPS1120L-DIN-C	54.2	71.0	72.0	118.0	116	2.0	12	1
	8	<input type="checkbox"/>	MPS1120-L8C	91.6	129.0	132.0	178.0	176	2.0	12	1
	10	<input type="checkbox"/>	MPS1120-L10C	114.0	152.0	155.0	201.0	199	2.0	12	1
	12	<input type="checkbox"/>	MPS1120-L12C	136.4	175.0	178.0	224.0	222	2.0	12	1
	15	<input type="checkbox"/>	MPS1120-L15C	170.0	209.0	212.0	258.0	256	2.0	12	1
	20	<input type="checkbox"/>	MPS1120-L20C	226.0	267.0	270.0	316.0	314	2.0	12	1
25	<input type="checkbox"/>	MPS1120-L25C	282.0	324.0	327.0	373.0	371	2.0	12	1	
11.3	3	<input type="checkbox"/>	MPS1130S-DIN-C	38.1	55.1	56.1	102.1	100	2.1	12	1
	5	<input type="checkbox"/>	MPS1130L-DIN-C	54.1	71.1	72.1	118.1	116	2.1	12	1
	8	<input type="checkbox"/>	MPS1130-L8C	92.5	129.1	132.1	178.1	176	2.1	12	1
	10	<input type="checkbox"/>	MPS1130-L10C	115.1	152.1	155.1	201.1	199	2.1	12	1
	12	<input type="checkbox"/>	MPS1130-L12C	137.7	175.1	178.0	224.0	222	2.1	12	1
	15	<input type="checkbox"/>	MPS1130-L15C	171.6	209.1	212.1	258.1	256	2.1	12	1
	20	<input type="checkbox"/>	MPS1130-L20C	228.1	267.1	270.1	316.1	314	2.1	12	1
25	<input type="checkbox"/>	MPS1130-L25C	284.6	324.1	327.1	373.1	371	2.1	12	1	
11.4	3	<input type="checkbox"/>	MPS1140S-DIN-C	38.0	55.1	56.1	102.1	100	2.1	12	1
	5	<input type="checkbox"/>	MPS1140L-DIN-C	54.0	71.1	72.1	118.1	116	2.1	12	1
	8	<input type="checkbox"/>	MPS1140-L8C	93.3	129.1	132.1	178.1	176	2.1	12	1
	10	<input type="checkbox"/>	MPS1140-L10C	116.1	152.1	155.1	201.1	199	2.1	12	1
	12	<input type="checkbox"/>	MPS1140-L12C	138.9	175.1	178.0	224.0	222	2.1	12	1
	15	<input type="checkbox"/>	MPS1140-L15C	173.1	209.1	212.1	258.1	256	2.1	12	1
	20	<input type="checkbox"/>	MPS1140-L20C	230.1	267.1	270.1	316.1	314	2.1	12	1
25	<input type="checkbox"/>	MPS1140-L25C	287.1	324.1	327.1	373.1	371	2.1	12	1	
11.5	3	<input type="checkbox"/>	MPS1150S-DIN-C	37.8	55.1	56.1	102.1	100	2.1	12	1
	5	<input type="checkbox"/>	MPS1150L-DIN-C	53.8	71.1	72.1	118.1	116	2.1	12	1
	8	<input type="checkbox"/>	MPS1150-L8C	94.1	129.1	132.1	178.1	176	2.1	12	1
	10	<input type="checkbox"/>	MPS1150-L10C	117.1	152.1	155.1	201.1	199	2.1	12	1
	12	<input type="checkbox"/>	MPS1150-L12C	140.1	175.1	178.0	224.0	222	2.1	12	1
	15	<input type="checkbox"/>	MPS1150-L15C	174.6	209.1	212.1	258.1	256	2.1	12	1
	20	<input type="checkbox"/>	MPS1150-L20C	232.1	267.1	270.1	316.1	314	2.1	12	1
25	<input type="checkbox"/>	MPS1150-L25C	289.6	324.1	327.1	373.1	371	2.1	12	1	

DC (мм)	Глубина сверления (L/D)	VP15TF	Обозначение	Размеры (мм)							Тип
				LU	LCF	LH	OAL	LF	PL	DCON	
11.6	3	<input type="checkbox"/>	MPS1160S-DIN-C	37.7	55.1	56.1	102.1	100	2.1	12	1
	5	<input type="checkbox"/>	MPS1160L-DIN-C	53.7	71.1	72.1	118.1	116	2.1	12	1
	8	<input type="checkbox"/>	MPS1160-L8C	94.9	134.1	137.1	183.1	181	2.1	12	1
	10	<input type="checkbox"/>	MPS1160-L10C	118.1	158.1	161.1	207.1	205	2.1	12	1
	12	<input type="checkbox"/>	MPS1160-L12C	141.3	182.1	185.1	231.1	229	2.1	12	1
	15	<input type="checkbox"/>	MPS1160-L15C	176.1	218.1	221.1	267.1	265	2.1	12	1
	20	<input type="checkbox"/>	MPS1160-L20C	234.1	278.1	281.1	327.1	325	2.1	12	1
25	<input type="checkbox"/>	MPS1160-L25C	292.1	338.1	341.1	387.1	385	2.1	12	1	
11.7	3	<input type="checkbox"/>	MPS1170S-DIN-C	37.6	55.1	56.1	102.1	100	2.1	12	1
	5	<input type="checkbox"/>	MPS1170L-DIN-C	53.6	71.1	72.1	118.1	116	2.1	12	1
	8	<input type="checkbox"/>	MPS1170-L8C	95.7	134.1	137.1	183.1	181	2.1	12	1
	10	<input type="checkbox"/>	MPS1170-L10C	119.1	158.1	161.1	207.1	205	2.1	12	1
	12	<input type="checkbox"/>	MPS1170-L12C	142.5	182.1	185.1	231.1	229	2.1	12	1
	15	<input type="checkbox"/>	MPS1170-L15C	177.6	218.1	221.1	267.1	265	2.1	12	1
	20	<input type="checkbox"/>	MPS1170-L20C	236.1	278.1	281.1	327.1	325	2.1	12	1
25	<input type="checkbox"/>	MPS1170-L25C	294.6	338.1	341.1	387.1	385	2.1	12	1	
11.8	3	<input type="checkbox"/>	MPS1180S-DIN-C	37.4	55.1	56.1	102.1	100	2.1	12	1
	5	<input type="checkbox"/>	MPS1180L-DIN-C	53.4	71.1	72.1	118.1	116	2.1	12	1
	8	<input type="checkbox"/>	MPS1180-L8C	96.5	134.1	137.1	183.1	181	2.1	12	1
	10	<input type="checkbox"/>	MPS1180-L10C	120.1	158.1	161.1	207.1	205	2.1	12	1
	12	<input type="checkbox"/>	MPS1180-L12C	143.7	182.1	185.1	231.1	229	2.1	12	1
	15	<input type="checkbox"/>	MPS1180-L15C	179.1	218.1	221.1	267.1	265	2.1	12	1
	20	<input type="checkbox"/>	MPS1180-L20C	238.1	278.1	281.1	327.1	325	2.1	12	1
25	<input type="checkbox"/>	MPS1180-L25C	297.1	338.1	341.1	387.1	385	2.1	12	1	
11.9	3	<input type="checkbox"/>	MPS1190S-DIN-C	37.3	55.2	56.2	102.2	100	2.2	12	1
	5	<input type="checkbox"/>	MPS1190L-DIN-C	53.3	71.2	72.2	118.2	116	2.2	12	1
	8	<input type="checkbox"/>	MPS1190-L8C	97.4	134.2	137.2	183.2	181	2.2	12	1
	10	<input type="checkbox"/>	MPS1190-L10C	121.2	158.2	161.2	207.2	205	2.2	12	1
	12	<input type="checkbox"/>	MPS1190-L12C	145.0	182.2	185.2	231.2	229	2.2	12	1
	15	<input type="checkbox"/>	MPS1190-L15C	180.7	218.2	221.2	267.2	265	2.2	12	1
	20	<input type="checkbox"/>	MPS1190-L20C	240.2	278.2	281.2	327.2	325	2.2	12	1
25	<input type="checkbox"/>	MPS1190-L25C	299.7	338.2	341.2	387.2	385	2.2	12	1	
12.0	3	<input type="checkbox"/>	MPS1200S-DIN-C	37.2	55.2	56.2	102.2	100	2.2	12	2
	5	<input type="checkbox"/>	MPS1200L-DIN-C	53.2	71.2	72.2	118.2	116	2.2	12	2
	8	<input type="checkbox"/>	MPS1200-L8C	98.2	134.2	137.2	183.2	181	2.2	12	2
	10	<input type="checkbox"/>	MPS1200-L10C	122.2	158.2	161.2	207.2	205	2.2	12	2
	12	<input type="checkbox"/>	MPS1200-L12C	146.2	182.2	185.2	231.2	229	2.2	12	2
	15	<input type="checkbox"/>	MPS1200-L15C	182.2	218.2	221.2	267.2	265	2.2	12	2
	20	<input type="checkbox"/>	MPS1200-L20C	242.2	278.2	281.2	327.2	325	2.2	12	2
25	<input type="checkbox"/>	MPS1200-L25C	302.2	338.2	341.2	387.2	385	2.2	12	2	
12.05	3	<input type="checkbox"/>	MPS1205S-DIN-C	42.1	60.2	61.2	107.2	105	2.2	14	1
	5	<input type="checkbox"/>	MPS1205L-DIN-C	59.1	77.2	78.2	124.2	122	2.2	14	1
12.1	3	<input type="checkbox"/>	MPS1210S-DIN-C	42.1	60.2	61.2	107.2	105	2.2	14	1
	5	<input type="checkbox"/>	MPS1210L-DIN-C	59.1	77.2	78.2	124.2	122	2.2	14	1
	8	<input type="checkbox"/>	MPS1210-L8C	99.0	140.2	143.2	189.2	187	2.2	14	1
	10	<input type="checkbox"/>	MPS1210-L10C	123.2	165.2	168.2	214.2	212	2.2	14	1
	12	<input type="checkbox"/>	MPS1210-L12C	147.4	190.2	193.2	239.2	237	2.2	14	1
	15	<input type="checkbox"/>	MPS1210-L15C	183.7	227.2	230.2	276.2	274	2.2	14	1
	20	<input type="checkbox"/>	MPS1210-L20C	244.2	290.2	293.2	339.2	337	2.2	14	1
12.2	3	<input type="checkbox"/>	MPS1220S-DIN-C	41.9	60.2	61.2	107.2	105	2.2	14	1
	5	<input type="checkbox"/>	MPS1220L-DIN-C	58.9	77.2	78.2	124.2	122	2.2	14	1
	8	<input type="checkbox"/>	MPS1220-L8C	99.8	140.2	143.2	189.2	187	2.2	14	1
	10	<input type="checkbox"/>	MPS1220-L10C	124.2	165.2	168.2	214.2	212	2.2	14	1
	12	<input type="checkbox"/>	MPS1220-L12C	148.6	190.2	193.2	239.2	237	2.2	14	1
	15	<input type="checkbox"/>	MPS1220-L15C	185.2	227.2	230.2	276.2	274	2.2	14	1
	20	<input type="checkbox"/>	MPS1220-L20C	246.2	290.2	293.2	339.2	337	2.2	14	1

: Нет на складе, выпуска

DC (мм)	Глубина сверления (L/D)	VP15TF	Обозначение	Размеры (мм)							Тип
				LU	LCF	LH	OAL	LF	PL	DCON	
12.3	3	□	MPS1230S-DIN-C	41.8	60.2	61.2	107.2	105	2.2	14	1
	5	□	MPS1230L-DIN-C	58.8	77.2	78.2	124.2	122	2.2	14	1
	8	□	MPS1230-L8C	100.6	140.2	143.2	189.2	187	2.2	14	1
	10	□	MPS1230-L10C	125.2	165.2	168.2	214.2	212	2.2	14	1
	12	□	MPS1230-L12C	149.8	190.2	193.2	239.2	237	2.2	14	1
	15	□	MPS1230-L15C	186.7	227.2	230.2	276.2	274	2.2	14	1
20	□	MPS1230-L20C	248.2	290.2	293.2	339.2	337	2.2	14	1	
12.4	3	□	MPS1240S-DIN-C	41.7	60.3	61.3	107.3	105	2.3	14	1
	5	□	MPS1240L-DIN-C	58.7	77.3	78.3	124.3	122	2.3	14	1
	8	□	MPS1240-L8C	101.5	140.3	143.3	189.3	187	2.3	14	1
	10	□	MPS1240-L10C	126.3	165.3	168.3	214.3	212	2.3	14	1
	12	□	MPS1240-L12C	151.1	190.3	193.3	239.3	237	2.3	14	1
	15	□	MPS1240-L15C	188.3	227.3	230.3	276.3	274	2.3	14	1
20	□	MPS1240-L20C	250.3	290.3	293.3	339.3	337	2.3	14	1	
12.5	3	□	MPS1250S-DIN-C	41.5	60.3	61.3	107.3	105	2.3	14	1
	5	□	MPS1250L-DIN-C	58.5	77.3	78.3	124.3	122	2.3	14	1
	8	□	MPS1250-L8C	102.3	140.3	143.3	189.3	187	2.3	14	1
	10	□	MPS1250-L10C	127.3	165.3	168.3	214.3	212	2.3	14	1
	12	□	MPS1250-L12C	152.3	190.3	193.3	239.3	237	2.3	14	1
	15	□	MPS1250-L15C	189.8	227.3	230.3	276.3	274	2.3	14	1
20	□	MPS1250-L20C	252.3	290.3	293.3	339.3	337	2.3	14	1	
12.6	3	□	MPS1260S-DIN-C	41.4	60.3	61.3	107.3	105	2.3	14	1
	5	□	MPS1260L-DIN-C	58.4	77.3	78.3	124.3	122	2.3	14	1
	8	□	MPS1260-L8C	103.1	145.3	148.3	194.3	192	2.3	14	1
	10	□	MPS1260-L10C	128.3	171.3	174.3	220.3	218	2.3	14	1
	12	□	MPS1260-L12C	153.5	197.3	200.3	246.3	244	2.3	14	1
	15	□	MPS1260-L15C	191.3	236.3	239.3	285.3	283	2.3	14	1
20	□	MPS1260-L20C	254.3	301.3	304.3	350.3	348	2.3	14	1	
12.7	3	□	MPS1270S-DIN-C	41.3	60.3	61.3	107.3	105	2.3	14	1
	5	□	MPS1270L-DIN-C	58.3	77.3	78.3	124.3	122	2.3	14	1
	8	□	MPS1270-L8C	103.9	145.3	148.3	194.3	192	2.3	14	1
	10	□	MPS1270-L10C	129.3	171.3	174.3	220.3	218	2.3	14	1
	12	□	MPS1270-L12C	154.7	197.3	200.3	246.3	244	2.3	14	1
	15	□	MPS1270-L15C	192.8	236.3	239.3	285.3	283	2.3	14	1
20	□	MPS1270-L20C	256.3	301.3	304.3	350.3	348	2.3	14	1	
12.8	3	□	MPS1280S-DIN-C	41.1	60.3	61.3	107.3	105	2.3	14	1
	5	□	MPS1280L-DIN-C	58.1	77.3	78.3	124.3	122	2.3	14	1
	8	□	MPS1280-L8C	104.7	145.3	148.3	194.3	192	2.3	14	1
	10	□	MPS1280-L10C	130.3	171.3	174.3	220.3	218	2.3	14	1
	12	□	MPS1280-L12C	155.9	197.3	200.3	246.3	244	2.3	14	1
	15	□	MPS1280-L15C	194.3	236.3	239.3	285.3	283	2.3	14	1
20	□	MPS1280-L20C	258.3	301.3	304.3	350.3	348	2.3	14	1	
12.9	3	□	MPS1290S-DIN-C	41.0	60.3	61.3	107.3	105	2.3	14	1
	5	□	MPS1290L-DIN-C	58.0	77.3	78.3	124.3	122	2.3	14	1
	8	□	MPS1290-L8C	105.5	145.3	148.3	194.3	192	2.3	14	1
	10	□	MPS1290-L10C	131.3	171.3	174.3	220.3	218	2.3	14	1
	12	□	MPS1290-L12C	157.1	197.3	200.3	246.3	244	2.3	14	1
	15	□	MPS1290-L15C	195.8	236.3	239.3	285.3	283	2.3	14	1
20	□	MPS1290-L20C	260.3	301.3	304.3	350.3	348	2.3	14	1	
13.0	3	□	MPS1300S-DIN-C	40.9	60.4	61.4	107.4	105	2.4	14	1
	5	□	MPS1300L-DIN-C	57.9	77.4	78.4	124.4	122	2.4	14	1
	8	□	MPS1300-L8C	106.4	145.4	148.4	194.4	192	2.4	14	1
	10	□	MPS1300-L10C	132.4	171.4	174.4	220.4	218	2.4	14	1
	12	□	MPS1300-L12C	158.4	197.4	200.4	246.4	244	2.4	14	1
	15	□	MPS1300-L15C	197.4	236.4	239.4	285.4	283	2.4	14	1
20	□	MPS1300-L20C	262.4	301.4	304.4	350.4	348	2.4	14	1	

DC (мм)	Глубина сверления (L/D)	VP15TF	Обозначение	Размеры (мм)							Тип
				LU	LCF	LH	OAL	LF	PL	DCON	
13.1	3	□	MPS1310S-DIN-C	40.7	60.4	61.4	107.4	105	2.4	14	1
	5	□	MPS1310L-DIN-C	57.7	77.4	78.4	124.4	122	2.4	14	1
	8	□	MPS1310-L8C	107.2	151.4	154.4	200.4	198	2.4	14	1
	10	□	MPS1310-L10C	133.4	178.4	181.4	227.4	225	2.4	14	1
	12	□	MPS1310-L12C	159.6	205.4	208.4	254.4	252	2.4	14	1
	15	□	MPS1310-L15C	198.9	245.4	248.4	294.4	292	2.4	14	1
20	□	MPS1310-L20C	264.4	313.4	316.4	362.4	360	2.4	14	1	
13.2	3	□	MPS1320S-DIN-C	40.6	60.4	61.4	107.4	105	2.4	14	1
	5	□	MPS1320L-DIN-C	57.6	77.4	78.4	124.4	122	2.4	14	1
	8	□	MPS1320-L8C	108.0	151.4	154.4	200.4	198	2.4	14	1
	10	□	MPS1320-L10C	134.4	178.4	181.4	227.4	225	2.4	14	1
	12	□	MPS1320-L12C	160.8	205.4	208.4	254.4	252	2.4	14	1
	15	□	MPS1320-L15C	200.4	245.4	248.4	294.4	292	2.4	14	1
20	□	MPS1320-L20C	266.4	313.4	316.4	362.4	360	2.4	14	1	
13.3	3	□	MPS1330S-DIN-C	40.5	60.4	61.4	107.4	105	2.4	14	1
	5	□	MPS1330L-DIN-C	57.5	77.4	78.4	124.4	122	2.4	14	1
	8	□	MPS1330-L8C	108.8	151.4	154.4	200.4	198	2.4	14	1
	10	□	MPS1330-L10C	135.4	178.4	181.4	227.4	225	2.4	14	1
	12	□	MPS1330-L12C	162.0	205.4	208.4	254.4	252	2.4	14	1
	15	□	MPS1330-L15C	201.9	245.4	248.4	294.4	292	2.4	14	1
20	□	MPS1330-L20C	268.4	313.4	316.4	362.4	360	2.4	14	1	
13.4	3	□	MPS1340S-DIN-C	40.3	60.4	61.4	107.4	105	2.4	14	1
	5	□	MPS1340L-DIN-C	57.3	77.4	78.4	124.4	122	2.4	14	1
	8	□	MPS1340-L8C	109.6	151.4	154.4	200.4	198	2.4	14	1
	10	□	MPS1340-L10C	136.4	178.4	181.4	227.4	225	2.4	14	1
	12	□	MPS1340-L12C	163.2	205.4	208.4	254.4	252	2.4	14	1
	15	□	MPS1340-L15C	203.4	245.4	248.4	294.4	292	2.4	14	1
20	□	MPS1340-L20C	270.4	313.4	316.4	362.4	360	2.4	14	1	
13.5	3	□	MPS1350S-DIN-C	40.2	60.5	61.5	107.5	105	2.5	14	1
	5	□	MPS1350L-DIN-C	57.2	77.5	78.5	124.5	122	2.5	14	1
	8	□	MPS1350-L8C	110.5	151.5	154.5	200.5	198	2.5	14	1
	10	□	MPS1350-L10C	137.5	178.5	181.5	227.5	225	2.5	14	1
	12	□	MPS1350-L12C	164.5	205.5	208.5	254.5	252	2.5	14	1
	15	□	MPS1350-L15C	205.0	245.5	248.5	294.5	292	2.5	14	1
20	□	MPS1350-L20C	272.5	313.5	316.5	362.5	360	2.5	14	1	
13.6	3	□	MPS1360S-DIN-C	40.1	60.5	61.5	107.5	105	2.5	14	1
	5	□	MPS1360L-DIN-C	57.1	77.5	78.5	124.5	122	2.5	14	1
	8	□	MPS1360-L8C	111.3	156.5	159.5	205.5	203	2.5	14	1
	10	□	MPS1360-L10C	138.5	184.5	187.5	233.5	231	2.5	14	1
	12	□	MPS1360-L12C	165.7	212.5	215.5	261.5	259	2.5	14	1
	15	□	MPS1360-L15C	206.5	254.5	257.5	303.5	301	2.5	14	1
20	□	MPS1360-L20C	274.5	324.5	327.5	373.5	371	2.5	14	1	
13.7	3	□	MPS1370S-DIN-C	39.9	60.5	61.5	107.5	105	2.5	14	1
	5	□	MPS1370L-DIN-C	56.9	77.5	78.5	124.5	122	2.5	14	1
	8	□	MPS1370-L8C	112.1	156.5	159.5	205.5	203	2.5	14	1
	10	□	MPS1370-L10C	139.5	184.5	187.5	233.5	231	2.5	14	1
	12	□	MPS1370-L12C	166.9	212.5	215.5	261.5	259	2.5	14	1
	15	□	MPS1370-L15C	208.0	254.5	257.5	303.5	301	2.5	14	1
20	□	MPS1370-L20C	276.5	324.5	327.5	373.5	371	2.5	14	1	
13.8	3	□	MPS1380S-DIN-C	39.8	60.5	61.5	107.5	105	2.5	14	1
	5	□	MPS1380L-DIN-C	56.8	77.5	78.5	124.5	122	2.5	14	1
	8	□	MPS1380-L8C	112.9	156.5	159.5	205.5	203	2.5	14	1
	10	□	MPS1380-L10C	140.5	184.5	187.5	233.5	231	2.5	14	1
	12	□	MPS1380-L12C	168.1	212.5	215.5	261.5	259	2.5	14	1
	15	□	MPS1380-L15C	209.5	254.5	257.5	303.5	301	2.5	14	1
20	□	MPS1380-L20C	278.5	324.5	327.5	373.5	371	2.5	14	1	

ИНСТРУМЕНТ ДЛЯ СВЕРЛЕНИЯ (МОНОЛИТНЫЕ ТВЕРДОСПЛАВНЫЕ СВЕРЛА)

MPS

Сверхдлинные сверла с четырьмя ленточками

ТВЕРДЫЙ СПЛАВ

ИНСТРУМЕНТ ДЛЯ СВЕРЛЕНИЯ

M

DC (мм)	Глубина сверления (L/D)	VP15TF	Обозначение	Размеры (мм)							Тип
				LU	LCF	LH	OAL	LF	PL	DCON	
13.9	3	<input type="checkbox"/>	MPS1390S-DIN-C	39.7	60.5	61.5	107.5	105	2.5	14	1
	5	<input type="checkbox"/>	MPS1390L-DIN-C	56.7	77.5	78.5	124.5	122	2.5	14	1
	8	<input type="checkbox"/>	MPS1390-L8C	113.7	156.5	159.5	205.5	203	2.5	14	1
	10	<input type="checkbox"/>	MPS1390-L10C	141.5	184.5	187.5	233.5	231	2.5	14	1
	12	<input type="checkbox"/>	MPS1390-L12C	169.3	212.5	215.5	261.5	259	2.5	14	1
	15	<input type="checkbox"/>	MPS1390-L15C	211.0	254.5	257.5	303.5	301	2.5	14	1
20	<input type="checkbox"/>	MPS1390-L20C	280.5	324.5	327.5	373.5	371	2.5	14	1	
14.0	3	<input type="checkbox"/>	MPS1400S-DIN-C	39.5	60.5	61.5	107.5	105	2.5	14	2
	5	<input type="checkbox"/>	MPS1400L-DIN-C	56.5	77.5	78.5	124.5	122	2.5	14	2
	8	<input type="checkbox"/>	MPS1400-L8C	114.5	156.5	159.5	205.5	203	2.5	14	2
	10	<input type="checkbox"/>	MPS1400-L10C	142.5	184.5	187.5	233.5	231	2.5	14	2
	12	<input type="checkbox"/>	MPS1400-L12C	170.5	212.5	215.5	261.5	259	2.5	14	2
	15	<input type="checkbox"/>	MPS1400-L15C	212.5	254.5	257.5	303.5	301	2.5	14	2
20	<input type="checkbox"/>	MPS1400-L20C	282.5	324.5	327.5	373.5	371	2.5	14	2	
14.1	3	<input type="checkbox"/>	MPS1410S-DIN-C	43.4	64.6	65.6	114.6	112	2.6	16	1
	5	<input type="checkbox"/>	MPS1410L-DIN-C	61.4	82.6	83.6	132.6	130	2.6	16	1
14.2	3	<input type="checkbox"/>	MPS1420S-DIN-C	43.3	64.6	65.6	114.6	112	2.6	16	1
	5	<input type="checkbox"/>	MPS1420L-DIN-C	61.3	82.6	83.6	132.6	130	2.6	16	1
14.3	3	<input type="checkbox"/>	MPS1430S-DIN-C	43.2	64.6	65.6	114.6	112	2.6	16	1
	5	<input type="checkbox"/>	MPS1430L-DIN-C	61.2	82.6	83.6	132.6	130	2.6	16	1
14.4	3	<input type="checkbox"/>	MPS1440S-DIN-C	43.0	64.6	65.6	114.6	112	2.6	16	1
	5	<input type="checkbox"/>	MPS1440L-DIN-C	61.0	82.6	83.6	132.6	130	2.6	16	1
14.5	3	<input type="checkbox"/>	MPS1450S-DIN-C	42.9	64.6	65.6	114.6	112	2.6	16	1
	5	<input type="checkbox"/>	MPS1450L-DIN-C	60.9	82.6	83.6	132.6	130	2.6	16	1
14.6	3	<input type="checkbox"/>	MPS1460S-DIN-C	42.8	64.7	65.7	114.7	112	2.7	16	1
	5	<input type="checkbox"/>	MPS1460L-DIN-C	60.8	82.7	83.7	132.7	130	2.7	16	1
14.7	3	<input type="checkbox"/>	MPS1470S-DIN-C	42.6	64.7	65.7	114.7	112	2.7	16	1
	5	<input type="checkbox"/>	MPS1470L-DIN-C	60.6	82.7	83.7	132.7	130	2.7	16	1
14.8	3	<input type="checkbox"/>	MPS1480S-DIN-C	42.5	64.7	65.7	114.7	112	2.7	16	1
	5	<input type="checkbox"/>	MPS1480L-DIN-C	60.5	82.7	83.7	132.7	130	2.7	16	1
14.9	3	<input type="checkbox"/>	MPS1490S-DIN-C	42.4	64.7	65.7	114.7	112	2.7	16	1
	5	<input type="checkbox"/>	MPS1490L-DIN-C	60.4	82.7	83.7	132.7	130	2.7	16	1
15.0	3	<input type="checkbox"/>	MPS1500S-DIN-C	42.2	64.7	65.7	114.7	112	2.7	16	1
	5	<input type="checkbox"/>	MPS1500L-DIN-C	60.2	82.7	83.7	132.7	130	2.7	16	1
15.1	3	<input type="checkbox"/>	MPS1510S-DIN-C	42.1	64.7	65.7	114.7	112	2.7	16	1
	5	<input type="checkbox"/>	MPS1510L-DIN-C	60.1	82.7	83.7	132.7	130	2.7	16	1
15.2	3	<input type="checkbox"/>	MPS1520S-DIN-C	42.0	64.8	65.8	114.8	112	2.8	16	1
	5	<input type="checkbox"/>	MPS1520L-DIN-C	60.0	82.8	83.8	132.8	130	2.8	16	1
15.3	3	<input type="checkbox"/>	MPS1530S-DIN-C	41.8	64.8	65.8	114.8	112	2.8	16	1
	5	<input type="checkbox"/>	MPS1530L-DIN-C	59.8	82.8	83.8	132.8	130	2.8	16	1
15.4	3	<input type="checkbox"/>	MPS1540S-DIN-C	41.7	64.8	65.8	114.8	112	2.8	16	1
	5	<input type="checkbox"/>	MPS1540L-DIN-C	59.7	82.8	83.8	132.8	130	2.8	16	1
15.5	3	<input type="checkbox"/>	MPS1550S-DIN-C	41.6	64.8	65.8	114.8	112	2.8	16	1
	5	<input type="checkbox"/>	MPS1550L-DIN-C	59.6	82.8	83.8	132.8	130	2.8	16	1
15.6	3	<input type="checkbox"/>	MPS1560S-DIN-C	41.4	64.8	65.8	114.8	112	2.8	16	1
	5	<input type="checkbox"/>	MPS1560L-DIN-C	59.4	82.8	83.8	132.8	130	2.8	16	1
15.7	3	<input type="checkbox"/>	MPS1570S-DIN-C	41.3	64.9	65.9	114.9	112	2.9	16	1
	5	<input type="checkbox"/>	MPS1570L-DIN-C	59.3	82.9	83.9	132.9	130	2.9	16	1
15.8	3	<input type="checkbox"/>	MPS1580S-DIN-C	41.2	64.9	65.9	114.9	112	2.9	16	1
	5	<input type="checkbox"/>	MPS1580L-DIN-C	59.2	82.9	83.9	132.9	130	2.9	16	1
15.9	3	<input type="checkbox"/>	MPS1590S-DIN-C	41.0	64.9	65.9	114.9	112	2.9	16	1
	5	<input type="checkbox"/>	MPS1590L-DIN-C	59.0	82.9	83.9	132.9	130	2.9	16	1
16.0	3	<input type="checkbox"/>	MPS1600S-DIN-C	40.9	64.9	65.9	114.9	112	2.9	16	2
	5	<input type="checkbox"/>	MPS1600L-DIN-C	58.9	82.9	83.9	132.9	130	2.9	16	2
16.1	3	<input type="checkbox"/>	MPS1610S-DIN-C	48.8	72.9	73.9	122.9	120	2.9	18	1
	5	<input type="checkbox"/>	MPS1610L-DIN-C	68.8	92.9	93.9	142.9	140	2.9	18	1

DC (мм)	Глубина сверления (L/D)	VP15TF	Обозначение	Размеры (мм)							Тип
				LU	LCF	LH	OAL	LF	PL	DCON	
16.2	3	<input type="checkbox"/>	MPS1620S-DIN-C	48.6	72.9	73.9	122.9	120	2.9	18	1
	5	<input type="checkbox"/>	MPS1620L-DIN-C	68.6	92.9	93.9	142.9	140	2.9	18	1
16.3	3	<input type="checkbox"/>	MPS1630S-DIN-C	48.5	73.0	74.0	123.0	120	3.0	18	1
	5	<input type="checkbox"/>	MPS1630L-DIN-C	68.5	93.0	94.0	143.0	140	3.0	18	1
16.4	3	<input type="checkbox"/>	MPS1640S-DIN-C	48.4	73.0	74.0	123.0	120	3.0	18	1
	5	<input type="checkbox"/>	MPS1640L-DIN-C	68.4	93.0	94.0	143.0	140	3.0	18	1
16.5	3	<input type="checkbox"/>	MPS1650S-DIN-C	48.3	73.0	74.0	123.0	120	3.0	18	1
	5	<input type="checkbox"/>	MPS1650L-DIN-C	68.3	93.0	94.0	143.0	140	3.0	18	1
16.6	3	<input type="checkbox"/>	MPS1660S-DIN-C	48.1	73.0	74.0	123.0	120	3.0	18	1
	5	<input type="checkbox"/>	MPS1660L-DIN-C	68.1	93.0	94.0	143.0	140	3.0	18	1
16.7	3	<input type="checkbox"/>	MPS1670S-DIN-C	48.0	73.0	74.0	123.0	120	3.0	18	1
	5	<input type="checkbox"/>	MPS1670L-DIN-C	68.0	93.0	94.0	143.0	140	3.0	18	1
16.8	3	<input type="checkbox"/>	MPS1680S-DIN-C	47.9	73.1	74.1	123.1	120	3.1	18	1
	5	<input type="checkbox"/>	MPS1680L-DIN-C	67.9	93.1	94.1	143.1	140	3.1	18	1
16.9	3	<input type="checkbox"/>	MPS1690S-DIN-C	47.7	73.1	74.1	123.1	120	3.1	18	1
	5	<input type="checkbox"/>	MPS1690L-DIN-C	67.7	93.1	94.1	143.1	140	3.1	18	1
17.0	3	<input type="checkbox"/>	MPS1700S-DIN-C	47.6	73.1	74.1	123.1	120	3.1	18	1
	5	<input type="checkbox"/>	MPS1700L-DIN-C	67.6	93.1	94.1	143.1	140	3.1	18	1
17.1	3	<input type="checkbox"/>	MPS1710S-DIN-C	47.5	73.1	74.1	123.1	120	3.1	18	1
	5	<input type="checkbox"/>	MPS1710L-DIN-C	67.5	93.1	94.1	143.1	140	3.1	18	1
17.2	3	<input type="checkbox"/>	MPS1720S-DIN-C	47.3	73.1	74.1	123.1	120	3.1	18	1
	5	<input type="checkbox"/>	MPS1720L-DIN-C	67.3	93.1	94.1	143.1	140	3.1	18	1
17.3	3	<input type="checkbox"/>	MPS1730S-DIN-C	47.2	73.1	74.1	123.1	120	3.1	18	1
	5	<input type="checkbox"/>	MPS1730L-DIN-C	67.2	93.1	94.1	143.1	140	3.1	18	1
17.4	3	<input type="checkbox"/>	MPS1740S-DIN-C	47.1	73.2	74.2	123.2	120	3.2	18	1
	5	<input type="checkbox"/>	MPS1740L-DIN-C	67.1	93.2	94.2	143.2	140	3.2	18	1
17.5	3	<input type="checkbox"/>	MPS1750S-DIN-C	46.9	73.2	74.2	123.2	120	3.2	18	1
	5	<input type="checkbox"/>	MPS1750L-DIN-C	66.9	93.2	94.2	143.2	140	3.2	18	1
17.6	3	<input type="checkbox"/>	MPS1760S-DIN-C	46.8	73.2	74.2	123.2	120	3.2	18	1
	5	<input type="checkbox"/>	MPS1760L-DIN-C	66.8	93.2	94.2	143.2	140	3.2	18	1
17.7	3	<input type="checkbox"/>	MPS1770S-DIN-C	46.7	73.2	74.2	123.2	120	3.2	18	1
	5	<input type="checkbox"/>	MPS1770L-DIN-C	66.7	93.2	94.2	143.2	140	3.2	18	1
17.8	3	<input type="checkbox"/>	MPS1780S-DIN-C	46.5	73.2	74.2	123.2	120	3.2	18	1
	5	<input type="checkbox"/>	MPS1780L-DIN-C	66.5	93.2	94.2	143.2	140	3.2	18	1
17.9	3	<input type="checkbox"/>	MPS1790S-DIN-C	46.4	73.3	74.3	123.3	120	3.3	18	1
	5	<input type="checkbox"/>	MPS1790L-DIN-C	66.4	93.3	94.3	143.3	140	3.3	18	1
18.0	3	<input type="checkbox"/>	MPS1800S-DIN-C	46.3	73.3	74.3	123.3	120	3.3	18	2
	5	<input type="checkbox"/>	MPS1800L-DIN-C	66.3	93.3	94.3	143.3	140	3.3	18	2
18.1	3	<input type="checkbox"/>	MPS1810S-DIN-C	52.1	79.3	80.3	131.3	128	3.3	20	1
	5	<input type="checkbox"/>	MPS1810L-DIN-C	74.1	101.3	102.3	153.3	150	3.3	20	1
18.2	3	<input type="checkbox"/>	MPS1820S-DIN-C	52.0	79.3	80.3	131.3	128	3.3	20	1
	5	<input type="checkbox"/>	MPS1820L-DIN-C	74.0	101.3	102.3	153.3	150	3.3	20	1
18.3	3	<input type="checkbox"/>	MPS1830S-DIN-C	51.9	79.3	80.3	131.3	128	3.3	20	1
	5	<input type="checkbox"/>	MPS1830L-DIN-C	73.9	101.3	102.3	153.3	150	3.3	20	1
18.4	3	<input type="checkbox"/>	MPS1840S-DIN-C	51.7	79.3	80.3	131.3	128	3.3	20	1
	5	<input type="checkbox"/>	MPS1840L-DIN-C	73.7	101.3	102.3	153.3	150	3.3	20	1
18.5	3	<input type="checkbox"/>	MPS1850S-DIN-C	51.6	79.4	80.4	131.4	128	3.4	20	1
	5	<input type="checkbox"/>	MPS1850L-DIN-C	73.6	101.4	102.4	153.4	150	3.4	20	1
18.6	3	<input type="checkbox"/>	MPS1860S-DIN-C	51.5	79.4	80.4	131.4	128	3.4	20	1
	5	<input type="checkbox"/>	MPS1860L-DIN-C	73.5	101.4	102.4	153.4	150	3.4	20	1
18.7	3	<input type="checkbox"/>	MPS1870S-DIN-C	51.4	79.4	80.4	131.4	128	3.4	20	1
	5	<input type="checkbox"/>	MPS1870L-DIN-C	73.4	101.4	102.4	153.4	150	3.4	20	1
18.8	3	<input type="checkbox"/>	MPS1880S-DIN-C	51.2	79.4	80.4	131.4	128	3.4	20	1
	5	<input type="checkbox"/>	MPS1880L-DIN-C	73.2	101.4	102.4	153.4	150	3.4	20	1
18.9	3	<input type="checkbox"/>	MPS1890S-DIN-C	51.1	79.4	80.4</					

DC (мм)	Глубина сверления (L/D)	VP15TF	Обозначение	Размеры (мм)							Тип
				LU	LCF	LH	OAL	LF	PL	DCON	
19.0	3	<input type="checkbox"/>	MPS1900S-DIN-C	51.0	79.5	80.5	131.5	128	3.5	20	1
	5	<input type="checkbox"/>	MPS1900L-DIN-C	73.0	101.5	102.5	153.5	150	3.5	20	1
19.1	3	<input type="checkbox"/>	MPS1910S-DIN-C	50.8	79.5	80.5	131.5	128	3.5	20	1
	5	<input type="checkbox"/>	MPS1910L-DIN-C	72.8	101.5	102.5	153.5	150	3.5	20	1
19.2	3	<input type="checkbox"/>	MPS1920S-DIN-C	50.7	79.5	80.5	131.5	128	3.5	20	1
	5	<input type="checkbox"/>	MPS1920L-DIN-C	72.7	101.5	102.5	153.5	150	3.5	20	1
19.3	3	<input type="checkbox"/>	MPS1930S-DIN-C	50.6	79.5	80.5	131.5	128	3.5	20	1
	5	<input type="checkbox"/>	MPS1930L-DIN-C	72.6	101.5	102.5	153.5	150	3.5	20	1
19.4	3	<input type="checkbox"/>	MPS1940S-DIN-C	50.4	79.5	80.5	131.5	128	3.5	20	1
	5	<input type="checkbox"/>	MPS1940L-DIN-C	72.4	101.5	102.5	153.5	150	3.5	20	1
19.5	3	<input type="checkbox"/>	MPS1950S-DIN-C	50.3	79.5	80.5	131.5	128	3.5	20	1
	5	<input type="checkbox"/>	MPS1950L-DIN-C	72.3	101.5	102.5	153.5	150	3.5	20	1
19.6	3	<input type="checkbox"/>	MPS1960S-DIN-C	50.2	79.6	80.6	131.6	128	3.6	20	1
	5	<input type="checkbox"/>	MPS1960L-DIN-C	72.2	101.6	102.6	153.6	150	3.6	20	1
19.7	3	<input type="checkbox"/>	MPS1970S-DIN-C	50.0	79.6	80.6	131.6	128	3.6	20	1
	5	<input type="checkbox"/>	MPS1970L-DIN-C	72.0	101.6	102.6	153.6	150	3.6	20	1
19.8	3	<input type="checkbox"/>	MPS1980S-DIN-C	49.9	79.6	80.6	131.6	128	3.6	20	1
	5	<input type="checkbox"/>	MPS1980L-DIN-C	71.9	101.6	102.6	153.6	150	3.6	20	1
19.9	3	<input type="checkbox"/>	MPS1990S-DIN-C	49.8	79.6	80.6	131.6	128	3.6	20	1
	5	<input type="checkbox"/>	MPS1990L-DIN-C	71.8	101.6	102.6	153.6	150	3.6	20	1
20.0	3	<input type="checkbox"/>	MPS2000S-DIN-C	49.6	79.6	80.6	131.6	128	3.6	20	2
	5	<input type="checkbox"/>	MPS2000L-DIN-C	71.6	101.6	102.6	153.6	150	3.6	20	2

ИНСТРУМЕНТ ДЛЯ СВЕРЛЕНИЯ (МОНОЛИТНЫЕ ТВЕРДОСПЛАВНЫЕ СВЕРЛА)

MSL

- Глубина сверления 20-30 L/D.
- Сверло MSL с 2 фасками для точного и надежного сверления.



Сверхдлинные сверла с двумя ленточками



Внутреннее охлаждение



● Цилиндрический хвостовик

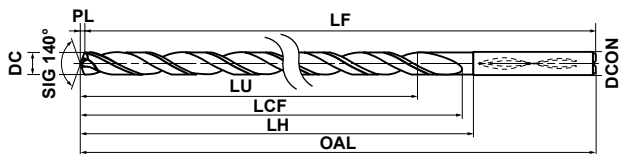

	3.0 ≤ DC ≤ 6.0	6.0 < DC ≤ 10.0	10.0 < DC ≤ 14.0
$\frac{0}{-0.012}$	$\frac{0}{-0.015}$	$\frac{0}{-0.018}$	
$\frac{0}{-0.008}$	$\frac{0}{-0.009}$	$\frac{0}{-0.011}$	

DC (мм)	Глубина сверления (L/D)	VP15TF	Обозначение	Размеры (мм)						
				LU	LCF	LH	OAL	LF	PL	DCON
3.0	20	<input type="checkbox"/>	MSL0300-L20C	60.5	69.5	72.5	109.5	109	0.5	6
	25	<input type="checkbox"/>	MSL0300-L25C	75.5	84.5	87.5	124.5	124	0.5	6
	30	<input type="checkbox"/>	MSL0300-L30C	90.5	99.5	102.5	139.5	139	0.5	6
3.1	20	<input type="checkbox"/>	MSL0310-L20C	62.6	81.6	84.6	121.6	121	0.6	6
	25	<input type="checkbox"/>	MSL0310-L25C	78.1	98.6	101.6	138.6	138	0.6	6
	30	<input type="checkbox"/>	MSL0310-L30C	93.6	116.6	119.6	156.6	156	0.6	6
3.2	20	<input type="checkbox"/>	MSL0320-L20C	64.6	81.6	84.6	121.6	121	0.6	6
	25	<input type="checkbox"/>	MSL0320-L25C	80.6	98.6	101.6	138.6	138	0.6	6
	30	<input type="checkbox"/>	MSL0320-L30C	96.6	116.6	119.6	156.6	156	0.6	6
3.3	20	<input type="checkbox"/>	MSL0330-L20C	66.6	81.6	84.6	121.6	121	0.6	6
	25	<input type="checkbox"/>	MSL0330-L25C	83.1	98.6	101.6	138.6	138	0.6	6
	30	<input type="checkbox"/>	MSL0330-L30C	99.6	116.6	119.6	156.6	156	0.6	6
3.4	20	<input type="checkbox"/>	MSL0340-L20C	68.6	81.6	84.6	121.6	121	0.6	6
	25	<input type="checkbox"/>	MSL0340-L25C	85.6	98.6	101.6	138.6	138	0.6	6
	30	<input type="checkbox"/>	MSL0340-L30C	102.6	116.6	119.6	156.6	156	0.6	6
3.5	20	<input type="checkbox"/>	MSL0350-L20C	70.6	81.6	84.6	121.6	121	0.6	6
	25	<input type="checkbox"/>	MSL0350-L25C	88.1	98.6	101.6	138.6	138	0.6	6
	30	<input type="checkbox"/>	MSL0350-L30C	105.6	116.6	119.6	156.6	156	0.6	6
3.6	20	<input type="checkbox"/>	MSL0360-L20C	72.7	92.7	95.7	132.7	132	0.7	6
	25	<input type="checkbox"/>	MSL0360-L25C	90.7	112.7	115.7	152.7	152	0.7	6
	30	<input type="checkbox"/>	MSL0360-L30C	108.7	132.7	135.7	172.7	172	0.7	6
3.7	20	<input type="checkbox"/>	MSL0370-L20C	74.7	92.7	95.7	132.7	132	0.7	6
	25	<input type="checkbox"/>	MSL0370-L25C	93.2	112.7	115.7	152.7	152	0.7	6
	30	<input type="checkbox"/>	MSL0370-L30C	111.7	132.7	135.7	172.7	172	0.7	6
3.8	20	<input type="checkbox"/>	MSL0380-L20C	76.7	92.7	95.7	132.7	132	0.7	6
	25	<input type="checkbox"/>	MSL0380-L25C	95.7	112.7	115.7	152.7	152	0.7	6
	30	<input type="checkbox"/>	MSL0380-L30C	114.7	132.7	135.7	172.7	172	0.7	6
3.9	20	<input type="checkbox"/>	MSL0390-L20C	78.7	92.7	95.7	132.7	132	0.7	6
	25	<input type="checkbox"/>	MSL0390-L25C	98.2	112.7	115.7	152.7	152	0.7	6
	30	<input type="checkbox"/>	MSL0390-L30C	117.7	132.7	135.7	172.7	172	0.7	6
4.0	20	<input type="checkbox"/>	MSL0400-L20C	80.7	92.7	95.7	132.7	132	0.7	6
	25	<input type="checkbox"/>	MSL0400-L25C	100.7	112.7	115.7	152.7	152	0.7	6
	30	<input type="checkbox"/>	MSL0400-L30C	120.7	132.7	135.7	172.7	172	0.7	6
4.1	20	<input type="checkbox"/>	MSL0410-L20C	82.7	104.7	107.7	144.7	144	0.7	6
	25	<input type="checkbox"/>	MSL0410-L25C	103.2	126.7	129.7	166.7	166	0.7	6
	30	<input type="checkbox"/>	MSL0410-L30C	123.7	149.7	152.7	189.7	189	0.7	6
4.2	20	<input type="checkbox"/>	MSL0420-L20C	84.8	104.8	107.8	144.8	144	0.8	6
	25	<input type="checkbox"/>	MSL0420-L25C	105.8	126.8	129.8	166.8	166	0.8	6
	30	<input type="checkbox"/>	MSL0420-L30C	126.8	149.8	152.8	189.8	189	0.8	6
4.3	20	<input type="checkbox"/>	MSL0430-L20C	86.8	104.8	107.8	144.8	144	0.8	6
	25	<input type="checkbox"/>	MSL0430-L25C	108.3	126.8	129.8	166.8	166	0.8	6
	30	<input type="checkbox"/>	MSL0430-L30C	129.8	149.8	152.8	189.8	189	0.8	6

DC (мм)	Глубина сверления (L/D)	VP15TF	Обозначение	Размеры (мм)						
				LU	LCF	LH	OAL	LF	PL	DCON
4.4	20	<input type="checkbox"/>	MSL0440-L20C	88.8	104.8	107.8	144.8	144	0.8	6
	25	<input type="checkbox"/>	MSL0440-L25C	110.8	126.8	129.8	166.8	166	0.8	6
	30	<input type="checkbox"/>	MSL0440-L30C	132.8	149.8	152.8	189.8	189	0.8	6
4.5	20	<input type="checkbox"/>	MSL0450-L20C	90.8	104.8	107.8	144.8	144	0.8	6
	25	<input type="checkbox"/>	MSL0450-L25C	113.3	126.8	129.8	166.8	166	0.8	6
	30	<input type="checkbox"/>	MSL0450-L30C	135.8	149.8	152.8	189.8	189	0.8	6
4.6	20	<input type="checkbox"/>	MSL0460-L20C	92.8	115.8	118.8	155.8	155	0.8	6
	25	<input type="checkbox"/>	MSL0460-L25C	115.8	140.8	143.8	180.8	180	0.8	6
	30	<input type="checkbox"/>	MSL0460-L30C	138.8	165.8	168.8	205.8	205	0.8	6
4.7	20	<input type="checkbox"/>	MSL0470-L20C	94.9	115.9	118.9	155.9	155	0.9	6
	25	<input type="checkbox"/>	MSL0470-L25C	118.4	140.9	143.9	180.9	180	0.9	6
	30	<input type="checkbox"/>	MSL0470-L30C	141.9	165.9	168.9	205.9	205	0.9	6
4.8	20	<input type="checkbox"/>	MSL0480-L20C	96.9	115.9	118.9	155.9	155	0.9	6
	25	<input type="checkbox"/>	MSL0480-L25C	120.9	140.9	143.9	180.9	180	0.9	6
	30	<input type="checkbox"/>	MSL0480-L30C	144.9	165.9	168.9	205.9	205	0.9	6
4.9	20	<input type="checkbox"/>	MSL0490-L20C	98.9	115.9	118.9	155.9	155	0.9	6
	25	<input type="checkbox"/>	MSL0490-L25C	123.4	140.9	143.9	180.9	180	0.9	6
	30	<input type="checkbox"/>	MSL0490-L30C	147.9	165.9	168.9	205.9	205	0.9	6
5.0	20	<input type="checkbox"/>	MSL0500-L20C	100.9	115.9	118.9	155.9	155	0.9	6
	25	<input type="checkbox"/>	MSL0500-L25C	125.9	140.9	143.9	180.9	180	0.9	6
	30	<input type="checkbox"/>	MSL0500-L30C	150.9	165.9	168.9	205.9	205	0.9	6
5.1	20	<input type="checkbox"/>	MSL0510-L20C	102.9	127.9	130.9	167.9	167	0.9	6
	25	<input type="checkbox"/>	MSL0510-L25C	128.4	154.9	157.9	194.9	194	0.9	6
	30	<input type="checkbox"/>	MSL0510-L30C	153.9	182.9	185.9	222.9	222	0.9	6
5.2	20	<input type="checkbox"/>	MSL0520-L20C	104.9	127.9	130.9	167.9	167	0.9	6
	25	<input type="checkbox"/>	MSL0520-L25C	130.9	154.9	157.9	194.9	194	0.9	6
	30	<input type="checkbox"/>	MSL0520-L30C	156.9	182.9	185.9	222.9	222	0.9	6
5.3	20	<input type="checkbox"/>	MSL0530-L20C	107.0	128.0	131.0	168.0	167	1.0	6
	25	<input type="checkbox"/>	MSL0530-L25C	133.5	155.0	158.0	195.0	194	1.0	6
	30	<input type="checkbox"/>	MSL0530-L30C	160.0	183.0	186.0	223.0	222	1.0	6
5.4	20	<input type="checkbox"/>	MSL0540-L20C	109.0	128.0	131.0	168.0	167	1.0	6
	25	<input type="checkbox"/>	MSL0540-L25C	136.0	155.0	158.0	195.0	194	1.0	6
	30	<input type="checkbox"/>	MSL0540-L30C	163.0	183.0	186.0	223.0	222	1.0	6
5.5	20	<input type="checkbox"/>	MSL0550-L20C	111.0	128.0	131.0	168.0	167	1.0	6
	25	<input type="checkbox"/>	MSL0550-L25C	138.5	155.0	158.0	195.0	194	1.0	6
	30	<input type="checkbox"/>	MSL0550-L30C	166.0	183.0	186.0	223.0	222	1.0	6
5.6	20	<input type="checkbox"/>	MSL0560-L20C	113.0	139.0	142.0	179.0	178	1.0	6
	25	<input type="checkbox"/>	MSL0560-L25C	141.0	169.0	172.0	209.0	208	1.0	6
	30	<input type="checkbox"/>	MSL0560-L30C	169.0	199.0	202.0	239.0	238	1.0	6
5.7	20	<input type="checkbox"/>	MSL0570-L20C	115.0	139.0	142.0	179.0	178	1.0	6
	25	<input type="checkbox"/>	MSL0570-L25C	143.5	169.0	172.0	209.0	208	1.0	6
	30	<input type="checkbox"/>	MSL0570-L30C	172.0	199.0	202.0	239.0	238	1.0	6



Пожалуйста, замените все будущие заказы изделий, отмеченных серым цветом (MPS, MSL), на серию MPS1 с немедленным вступлением в силу. Это связано с тем, что производство MPS, MSL будет постепенно прекращаться и остановится в марте 2023 года.

: Нет на складе, выпускается исключительно под заказ.

DC (мм)	Глубина сверления (L/D)	VP15TF	Обозначение	Размеры (мм)						
				LU	LCF	LH	OAL	LF	PL	DCON
5.8	20	□	MSL0580-L20C	117.1	139.1	142.1	179.1	178	1.1	6
	25	□	MSL0580-L25C	146.1	169.1	172.1	209.1	208	1.1	6
	30	□	MSL0580-L30C	175.1	199.1	202.1	239.1	238	1.1	6
5.9	20	□	MSL0590-L20C	119.1	139.1	142.1	179.1	178	1.1	6
	25	□	MSL0590-L25C	148.6	169.1	172.1	209.1	208	1.1	6
	30	□	MSL0590-L30C	178.1	199.1	202.1	239.1	238	1.1	6
6.0	20	□	MSL0600-L20C	121.1	139.1	142.1	179.1	178	1.1	6
	25	□	MSL0600-L25C	151.1	169.1	172.1	209.1	208	1.1	6
	30	□	MSL0600-L30C	181.1	199.1	202.1	239.1	238	1.1	6
6.1	20	□	MSL0610-L20C	123.1	151.1	154.1	191.1	190	1.1	8
	25	□	MSL0610-L25C	153.6	183.1	186.1	223.1	222	1.1	8
	30	□	MSL0610-L30C	184.1	216.1	219.1	256.1	255	1.1	8
6.2	20	□	MSL0620-L20C	125.1	151.1	154.1	191.1	190	1.1	8
	25	□	MSL0620-L25C	156.1	183.1	186.1	223.1	222	1.1	8
	30	□	MSL0620-L30C	187.1	216.1	219.1	256.1	255	1.1	8
6.3	20	□	MSL0630-L20C	127.1	151.1	154.1	191.1	190	1.1	8
	25	□	MSL0630-L25C	158.6	183.1	186.1	223.1	222	1.1	8
	30	□	MSL0630-L30C	190.1	216.1	219.1	256.1	255	1.1	8
6.4	20	□	MSL0640-L20C	129.2	151.2	154.2	191.2	190	1.2	8
	25	□	MSL0640-L25C	161.2	183.2	186.2	223.2	222	1.2	8
	30	□	MSL0640-L30C	193.2	216.2	219.2	256.2	255	1.2	8
6.5	20	□	MSL0650-L20C	131.2	151.2	154.2	191.2	190	1.2	8
	25	□	MSL0650-L25C	163.7	183.2	186.2	223.2	222	1.2	8
	30	□	MSL0650-L30C	196.2	216.2	219.2	256.2	255	1.2	8
6.6	20	□	MSL0660-L20C	133.2	162.2	165.2	202.2	201	1.2	8
	25	□	MSL0660-L25C	166.2	197.2	200.2	237.2	236	1.2	8
	30	□	MSL0660-L30C	199.2	232.2	235.2	272.2	271	1.2	8
6.7	20	□	MSL0670-L20C	135.2	162.2	165.2	202.2	201	1.2	8
	25	□	MSL0670-L25C	168.7	197.2	200.2	237.2	236	1.2	8
	30	□	MSL0670-L30C	202.2	232.2	235.2	272.2	271	1.2	8
6.8	20	□	MSL0680-L20C	137.2	162.2	165.2	202.2	201	1.2	8
	25	□	MSL0680-L25C	171.2	197.2	200.2	237.2	236	1.2	8
	30	□	MSL0680-L30C	205.2	232.2	235.2	272.2	271	1.2	8
6.9	20	□	MSL0690-L20C	139.3	162.3	165.3	202.3	201	1.3	8
	25	□	MSL0690-L25C	173.8	197.3	200.3	237.3	236	1.3	8
	30	□	MSL0690-L30C	208.3	232.3	235.3	272.3	271	1.3	8
7.0	20	□	MSL0700-L20C	141.3	162.3	165.3	202.3	201	1.3	8
	25	□	MSL0700-L25C	176.3	197.3	200.3	237.3	236	1.3	8
	30	□	MSL0700-L30C	211.3	232.3	235.3	272.3	271	1.3	8
7.1	20	□	MSL0710-L20C	143.3	174.3	177.3	214.3	213	1.3	8
	25	□	MSL0710-L25C	178.8	211.3	214.3	251.3	250	1.3	8
	30	□	MSL0710-L30C	214.3	249.3	252.3	289.3	288	1.3	8
7.2	20	□	MSL0720-L20C	145.3	174.3	177.3	214.3	213	1.3	8
	25	□	MSL0720-L25C	181.3	211.3	214.3	251.3	250	1.3	8
	30	□	MSL0720-L30C	217.3	249.3	252.3	289.3	288	1.3	8
7.3	20	□	MSL0730-L20C	147.3	174.3	177.3	214.3	213	1.3	8
	25	□	MSL0730-L25C	183.8	211.3	214.3	251.3	250	1.3	8
	30	□	MSL0730-L30C	220.3	249.3	252.3	289.3	288	1.3	8
7.4	20	□	MSL0740-L20C	149.3	174.3	177.3	214.3	213	1.3	8
	25	□	MSL0740-L25C	186.3	211.3	214.3	251.3	250	1.3	8
	30	□	MSL0740-L30C	223.3	249.3	252.3	289.3	288	1.3	8
7.5	20	□	MSL0750-L20C	151.4	174.4	177.4	214.4	213	1.4	8
	25	□	MSL0750-L25C	188.9	211.4	214.4	251.4	250	1.4	8
	30	□	MSL0750-L30C	226.4	249.4	252.4	289.4	288	1.4	8

DC (мм)	Глубина сверления (L/D)	VP15TF	Обозначение	Размеры (мм)						
				LU	LCF	LH	OAL	LF	PL	DCON
7.6	20	□	MSL0760-L20C	153.4	185.4	188.4	225.4	224	1.4	8
	25	□	MSL0760-L25C	191.4	225.4	228.4	265.4	264	1.4	8
	30	□	MSL0760-L30C	229.4	265.4	268.4	305.4	304	1.4	8
7.7	20	□	MSL0770-L20C	155.4	185.4	188.4	225.4	224	1.4	8
	25	□	MSL0770-L25C	193.9	225.4	228.4	265.4	264	1.4	8
	30	□	MSL0770-L30C	232.4	265.4	268.4	305.4	304	1.4	8
7.8	20	□	MSL0780-L20C	157.4	185.4	188.4	225.4	224	1.4	8
	25	□	MSL0780-L25C	196.4	225.4	228.4	265.4	264	1.4	8
	30	□	MSL0780-L30C	235.4	265.4	268.4	305.4	304	1.4	8
7.9	20	□	MSL0790-L20C	159.4	185.4	188.4	225.4	224	1.4	8
	25	□	MSL0790-L25C	198.9	225.4	228.4	265.4	264	1.4	8
	30	□	MSL0790-L30C	238.4	265.4	268.4	305.4	304	1.4	8
8.0	20	□	MSL0800-L20C	161.5	185.5	188.5	225.5	224	1.5	8
	25	□	MSL0800-L25C	201.5	225.5	228.5	265.5	264	1.5	8
	30	□	MSL0800-L30C	241.5	265.5	268.5	305.5	304	1.5	8
8.1	20	□	MSL0810-L20C	163.5	197.5	200.5	241.5	240	1.5	10
	25	□	MSL0810-L25C	204.0	239.5	242.5	283.5	282	1.5	10
	30	□	MSL0810-L30C	244.5	281.5	284.5	325.5	324	1.5	10
8.2	20	□	MSL0820-L20C	165.5	197.5	200.5	241.5	240	1.5	10
	25	□	MSL0820-L25C	206.5	239.5	242.5	283.5	282	1.5	10
	30	□	MSL0820-L30C	247.5	281.5	284.5	325.5	324	1.5	10
8.3	20	□	MSL0830-L20C	167.5	197.5	200.5	241.5	240	1.5	10
	25	□	MSL0830-L25C	209.0	239.5	242.5	283.5	282	1.5	10
	30	□	MSL0830-L30C	250.5	281.5	284.5	325.5	324	1.5	10
8.4	20	□	MSL0840-L20C	169.5	197.5	200.5	241.5	240	1.5	10
	25	□	MSL0840-L25C	211.5	239.5	242.5	283.5	282	1.5	10
	30	□	MSL0840-L30C	253.5	281.5	284.5	325.5	324	1.5	10
8.5	20	□	MSL0850-L20C	171.5	197.5	200.5	241.5	240	1.5	10
	25	□	MSL0850-L25C	214.0	239.5	242.5	283.5	282	1.5	10
	30	□	MSL0850-L30C	256.5	281.5	284.5	325.5	324	1.5	10
8.6	20	□	MSL0860-L20C	173.6	208.6	211.6	252.6	251	1.6	10
	25	□	MSL0860-L25C	216.6	253.6	256.6	297.6	296	1.6	10
	30	□	MSL0860-L30C	259.6	297.6	300.6	341.6	340	1.6	10
8.7	20	□	MSL0870-L20C	175.6	208.6	211.6	252.6	251	1.6	10
	25	□	MSL0870-L25C	219.1	253.6	256.6	297.6	296	1.6	10
	30	□	MSL0870-L30C	262.6	297.6	300.6	341.6	340	1.6	10
8.8	20	□	MSL0880-L20C	177.6	208.6	211.6	252.6	251	1.6	10
	25	□	MSL0880-L25C	221.6	253.6	256.6	297.6	296	1.6	10
	30	□	MSL0880-L30C	265.6	297.6	300.6	341.6	340	1.6	10
8.9	20	□	MSL0890-L20C	179.6	208.6	211.6	252.6	251	1.6	10
	25	□	MSL0890-L25C	224.1	253.6	256.6	297.6	296	1.6	10
	30	□	MSL0890-L30C	268.6	297.6	300.6	341.6	340	1.6	10
9.0	20	□	MSL0900-L20C	181.6	208.6	211.6	252.6	251	1.6	10
	25	□	MSL0900-L25C	226.6	253.6	256.6	297.6	296	1.6	10
	30	□	MSL0900-L30C	271.6	297.6	300.6	341.6	340	1.6	10
9.1	20	□	MSL0910-L20C	183.7	220.7	223.7	264.7	263	1.7	10
	25	□	MSL0910-L25C	229.2	267.7	270.7	311.7	310	1.7	10
	30	□	MSL0910-L30C	274.7	315.7	318.7	359.7	358	1.7	10
9.2	20	□	MSL0920-L20C	185.7	220.7	223.7	264.7	263	1.7	10
	25	□	MSL0920-L25C	231.7	267.7	270.7	311.7	310	1.7	10
	30	□	MSL0920-L30C	277.7	315.7	318.7	359.7	358	1.7	10
9.3	20	□	MSL0930-L20C	187.7	220.7	223.7	264.7	263	1.7	10
	25	□	MSL0930-L25C	234.2	267.7	270.7	311.7	310	1.7	10
	30	□	MSL0930-L30C	280.7	315.7	318.7	359.7	358	1.7	10

ИНСТРУМЕНТ ДЛЯ СВЕРЛЕНИЯ (МОНОЛИТНЫЕ ТВЕРДОСПЛАВНЫЕ СВЕРЛА)

MSL

Сверхдлинные сверла с двумя ленточками

ТВЕРДЫЙ СПЛАВ

М

ИНСТРУМЕНТ ДЛЯ СВЕРЛЕНИЯ

DC (мм)	Глубина сверления (L/D)	VP15TF	Обозначение	Размеры (мм)						
				LU	LCF	LH	OAL	LF	PL	DCON
9.4	20	<input type="checkbox"/>	MSL0940-L20C	189.7	220.7	223.7	264.7	263	1.7	10
	25	<input type="checkbox"/>	MSL0940-L25C	236.7	267.7	270.7	311.7	310	1.7	10
	30	<input type="checkbox"/>	MSL0940-L30C	283.7	315.7	318.7	359.7	358	1.7	10
9.5	20	<input type="checkbox"/>	MSL0950-L20C	191.7	220.7	223.7	264.7	263	1.7	10
	25	<input type="checkbox"/>	MSL0950-L25C	239.2	267.7	270.7	311.7	310	1.7	10
	30	<input type="checkbox"/>	MSL0950-L30C	286.7	315.7	318.7	359.7	358	1.7	10
9.6	20	<input type="checkbox"/>	MSL0960-L20C	193.7	231.7	234.7	275.7	274	1.7	10
	25	<input type="checkbox"/>	MSL0960-L25C	241.7	281.7	284.7	325.7	324	1.7	10
	30	<input type="checkbox"/>	MSL0960-L30C	289.7	331.7	334.7	375.7	374	1.7	10
9.7	20	<input type="checkbox"/>	MSL0970-L20C	195.8	231.8	234.8	275.8	274	1.8	10
	25	<input type="checkbox"/>	MSL0970-L25C	244.3	281.8	284.8	325.8	324	1.8	10
	30	<input type="checkbox"/>	MSL0970-L30C	292.8	331.8	334.8	375.8	374	1.8	10
9.8	20	<input type="checkbox"/>	MSL0980-L20C	197.8	231.8	234.8	275.8	274	1.8	10
	25	<input type="checkbox"/>	MSL0980-L25C	246.8	281.8	284.8	325.8	324	1.8	10
	30	<input type="checkbox"/>	MSL0980-L30C	295.8	331.8	334.8	375.8	374	1.8	10
9.9	20	<input type="checkbox"/>	MSL0990-L20C	199.8	231.8	234.8	275.8	274	1.8	10
	25	<input type="checkbox"/>	MSL0990-L25C	249.3	281.8	284.8	325.8	324	1.8	10
	30	<input type="checkbox"/>	MSL0990-L30C	298.8	331.8	334.8	375.8	374	1.8	10
10.0	20	<input type="checkbox"/>	MSL1000-L20C	201.8	231.8	234.8	275.8	274	1.8	10
	25	<input type="checkbox"/>	MSL1000-L25C	251.8	281.8	284.8	325.8	324	1.8	10
	30	<input type="checkbox"/>	MSL1000-L30C	301.8	331.8	334.8	375.8	374	1.8	10
10.1	20	<input type="checkbox"/>	MSL1010-L20C	203.8	243.8	246.8	292.8	291	1.8	12
	25	<input type="checkbox"/>	MSL1010-L25C	254.3	295.8	298.8	344.8	343	1.8	12
10.2	20	<input type="checkbox"/>	MSL1020-L20C	205.9	243.9	246.9	292.9	291	1.9	12
	25	<input type="checkbox"/>	MSL1020-L25C	256.9	295.9	298.9	344.9	343	1.9	12
10.3	20	<input type="checkbox"/>	MSL1030-L20C	207.9	243.9	246.9	292.9	291	1.9	12
	25	<input type="checkbox"/>	MSL1030-L25C	259.4	295.9	298.9	344.9	343	1.9	12
10.4	20	<input type="checkbox"/>	MSL1040-L20C	209.9	243.9	246.9	292.9	291	1.9	12
	25	<input type="checkbox"/>	MSL1040-L25C	261.9	295.9	298.9	344.9	343	1.9	12
10.5	20	<input type="checkbox"/>	MSL1050-L20C	211.9	243.9	246.9	292.9	291	1.9	12
	25	<input type="checkbox"/>	MSL1050-L25C	264.4	295.9	298.9	344.9	343	1.9	12
10.6	20	<input type="checkbox"/>	MSL1060-L20C	213.9	254.9	257.9	303.9	302	1.9	12
	25	<input type="checkbox"/>	MSL1060-L25C	266.9	309.9	312.9	358.9	357	1.9	12
10.7	20	<input type="checkbox"/>	MSL1070-L20C	215.9	254.9	257.9	303.9	302	1.9	12
	25	<input type="checkbox"/>	MSL1070-L25C	269.4	309.9	312.9	358.9	357	1.9	12
10.8	20	<input type="checkbox"/>	MSL1080-L20C	218.0	255.0	258.0	304.0	302	2.0	12
	25	<input type="checkbox"/>	MSL1080-L25C	272.0	310.0	313.0	359.0	357	2.0	12
10.9	20	<input type="checkbox"/>	MSL1090-L20C	220.0	255.0	258.0	304.0	302	2.0	12
	25	<input type="checkbox"/>	MSL1090-L25C	274.5	310.0	313.0	359.0	357	2.0	12
11.0	20	<input type="checkbox"/>	MSL1100-L20C	222.0	255.0	258.0	304.0	302	2.0	12
	25	<input type="checkbox"/>	MSL1100-L25C	277.0	310.0	313.0	359.0	357	2.0	12
11.1	20	<input type="checkbox"/>	MSL1110-L20C	224.0	267.0	270.0	316.0	314	2.0	12
	25	<input type="checkbox"/>	MSL1110-L25C	279.5	324.0	327.0	373.0	371	2.0	12
11.2	20	<input type="checkbox"/>	MSL1120-L20C	226.0	267.0	270.0	316.0	314	2.0	12
	25	<input type="checkbox"/>	MSL1120-L25C	282.0	324.0	327.0	373.0	371	2.0	12
11.3	20	<input type="checkbox"/>	MSL1130-L20C	228.1	267.1	270.1	316.1	314	2.1	12
	25	<input type="checkbox"/>	MSL1130-L25C	284.6	324.1	327.1	373.1	371	2.1	12
11.4	20	<input type="checkbox"/>	MSL1140-L20C	230.1	267.1	270.1	316.1	314	2.1	12
	25	<input type="checkbox"/>	MSL1140-L25C	287.1	324.1	327.1	373.1	371	2.1	12
11.5	20	<input type="checkbox"/>	MSL1150-L20C	232.1	267.1	270.1	316.1	314	2.1	12
	25	<input type="checkbox"/>	MSL1150-L25C	289.6	324.1	327.1	373.1	371	2.1	12
11.6	20	<input type="checkbox"/>	MSL1160-L20C	234.1	278.1	281.1	327.1	325	2.1	12
	25	<input type="checkbox"/>	MSL1160-L25C	292.1	338.1	341.1	387.1	385	2.1	12

DC (мм)	Глубина сверления (L/D)	VP15TF	Обозначение	Размеры (мм)						
				LU	LCF	LH	OAL	LF	PL	DCON
11.7	20	<input type="checkbox"/>	MSL1170-L20C	236.1	278.1	281.1	327.1	325	2.1	12
	25	<input type="checkbox"/>	MSL1170-L25C	294.6	338.1	341.1	387.1	385	2.1	12
11.8	20	<input type="checkbox"/>	MSL1180-L20C	238.1	278.1	281.1	327.1	325	2.1	12
	25	<input type="checkbox"/>	MSL1180-L25C	297.1	338.1	341.1	387.1	385	2.1	12
11.9	20	<input type="checkbox"/>	MSL1190-L20C	240.2	278.2	281.2	327.2	325	2.2	12
	25	<input type="checkbox"/>	MSL1190-L25C	299.7	338.2	341.2	387.2	385	2.2	12
12.0	20	<input type="checkbox"/>	MSL1200-L20C	242.2	278.2	281.2	327.2	325	2.2	12
	25	<input type="checkbox"/>	MSL1200-L25C	302.2	338.2	341.2	387.2	385	2.2	12
12.1	20	<input type="checkbox"/>	MSL1210-L20C	244.2	290.2	293.2	339.2	337	2.2	14
12.2	20	<input type="checkbox"/>	MSL1220-L20C	246.2	290.2	293.2	339.2	337	2.2	14
12.3	20	<input type="checkbox"/>	MSL1230-L20C	248.2	290.2	293.2	339.2	337	2.2	14
12.4	20	<input type="checkbox"/>	MSL1240-L20C	250.3	290.3	293.3	339.3	337	2.3	14
12.5	20	<input type="checkbox"/>	MSL1250-L20C	252.3	290.3	293.3	339.3	337	2.3	14
12.6	20	<input type="checkbox"/>	MSL1260-L20C	254.3	301.3	304.3	350.3	348	2.3	14
12.7	20	<input type="checkbox"/>	MSL1270-L20C	256.3	301.3	304.3	350.3	348	2.3	14
12.8	20	<input type="checkbox"/>	MSL1280-L20C	258.3	301.3	304.3	350.3	348	2.3	14
12.9	20	<input type="checkbox"/>	MSL1290-L20C	260.3	301.3	304.3	350.3	348	2.3	14
13.0	20	<input type="checkbox"/>	MSL1300-L20C	262.4	301.4	304.4	350.4	348	2.4	14
13.1	20	<input type="checkbox"/>	MSL1310-L20C	264.4	313.4	316.4	362.4	360	2.4	14
13.2	20	<input type="checkbox"/>	MSL1320-L20C	266.4	313.4	316.4	362.4	360	2.4	14
13.3	20	<input type="checkbox"/>	MSL1330-L20C	268.4	313.4	316.4	362.4	360	2.4	14
13.4	20	<input type="checkbox"/>	MSL1340-L20C	270.4	313.4	316.4	362.4	360	2.4	14
13.5	20	<input type="checkbox"/>	MSL1350-L20C	272.5	313.5	316.5	362.5	360	2.5	14
13.6	20	<input type="checkbox"/>	MSL1360-L20C	274.5	324.5	327.5	373.5	371	2.5	14
13.7	20	<input type="checkbox"/>	MSL1370-L20C	276.5	324.5	327.5	373.5	371	2.5	14
13.8	20	<input type="checkbox"/>	MSL1380-L20C	278.5	324.5	327.5	373.5	371	2.5	14
13.9	20	<input type="checkbox"/>	MSL1390-L20C	280.5	324.5	327.5	373.5	371	2.5	14
14.0	20	<input type="checkbox"/>	MSL1400-L20C	282.5	324.5	327.5	373.5	371	2.5	14

: Нет на складе, выпускается исключительно под заказ.

РЕКОМЕНДУЕМЫЕ РЕЖИМЫ РЕЗАНИЯ

● MPS СВЕРЛА (3xDC, 5xDC, 8xDC, 12xDC)

Обрабатываемый материал	Диаметр сверла	φ 3.0—φ 6.0		φ 6.0—φ 10.0		φ 10.0—φ 14.0		φ 14.0—φ 20.0	
	Условия Твердость	Скорость резания (м/мин)	Подача (мм/об)	Скорость резания (м/мин)	Подача (мм/об)	Скорость резания (м/мин)	Подача (мм/об)	Скорость резания (м/мин)	Подача (мм/об)
P Малоуглеродистые стали	≤180НВ	110 (50—120)	0.20 (0.15—0.25)	130 (80—140)	0.25 (0.20—0.35)	150 (90—170)	0.30 (0.20—0.40)	160 (100—180)	0.35 (0.20—0.40)
	180—280НВ	90 (50—100)	0.20 (0.15—0.25)	110 (70—120)	0.25 (0.20—0.35)	130 (80—140)	0.25 (0.20—0.40)	140 (100—150)	0.30 (0.20—0.40)
	280—350НВ	80 (40—90)	0.20 (0.15—0.30)	90 (60—110)	0.25 (0.15—0.30)	110 (70—130)	0.25 (0.15—0.40)	120 (90—140)	0.30 (0.20—0.40)
M Нержавеющая сталь	≤200НВ	50 (20—100)	0.10 (0.05—0.15)	60 (40—120)	0.20 (0.10—0.25)	70 (50—120)	0.25 (0.15—0.30)	80 (60—120)	0.25 (0.15—0.30)
K Чугун	Предел прочности ≤350МПа	100 (70—120)	0.25 (0.15—0.30)	130 (100—140)	0.30 (0.20—0.35)	150 (110—160)	0.35 (0.25—0.40)	160 (120—170)	0.35 (0.25—0.40)
	Предел прочности ≤450МПа	60 (30—80)	0.20 (0.15—0.25)	70 (40—90)	0.20 (0.15—0.30)	90 (50—110)	0.25 (0.20—0.40)	100 (60—110)	0.3 (0.20—0.40)
S Жаропрочные сплавы	—	20 (10—25)	0.10 (0.05—0.15)	25 (15—30)	0.12 (0.05—0.15)	25 (15—30)	0.15 (0.10—0.20)	30 (25—35)	0.15 (0.10—0.20)

● MPS СВЕРЛА (L/D=15—30), MSL СВЕРЛА (L/D=20—30)

Обрабатываемый материал	Диаметр сверла	φ 3.0—φ 6.0		φ 6.0—φ 10.0		φ 10.0—φ 14.0	
	Условия Твердость	Скорость резания (м/мин)	Подача (мм/об)	Скорость резания (м/мин)	Подача (мм/об)	Скорость резания (м/мин)	Подача (мм/об)
P Малоуглеродистые стали	≤180НВ	85 (35—100)	0.20 (0.15—0.25)	85 (45—120)	0.25 (0.15—0.35)	90 (55—120)	0.30 (0.20—0.35)
	180—280НВ	80 (40—95)	0.20 (0.15—0.25)	90 (50—120)	0.25 (0.20—0.35)	90 (60—130)	0.30 (0.15—0.35)
	280—350НВ	75 (35—80)	0.15 (0.15—0.20)	80 (45—115)	0.20 (0.15—0.25)	85 (55—115)	0.25 (0.15—0.30)
M Нержавеющая сталь	≤200НВ	50 (20—80)	0.10 (0.05—0.15)	60 (20—90)	0.12 (0.05—0.15)	70 (20—90)	0.15 (0.10—0.20)
K Чугун	Предел прочности ≤350МПа	70 (40—85)	0.25 (0.15—0.30)	75 (50—90)	0.30 (0.20—0.35)	80 (50—95)	0.35 (0.20—0.40)
	Предел прочности ≤450МПа	65 (35—80)	0.20 (0.15—0.25)	70 (45—85)	0.25 (0.15—0.30)	75 (45—90)	0.30 (0.20—0.35)
S Жаропрочные сплавы	—	20 (10—25)	0.10 (0.05—0.15)	25 (15—30)	0.12 (0.05—0.15)	25 (15—30)	0.15 (0.10—0.20)

● MPS СВЕРЛА (L/D=35—40)

Обрабатываемый материал	Диаметр сверла	φ 3.0—φ 4.0		φ 5.0—φ 6.0		φ 6.0—φ 9.0	
	Условия Твердость	Скорость резания (м/мин)	Подача (мм/об)	Скорость резания (м/мин)	Подача (мм/об)	Скорость резания (м/мин)	Подача (мм/об)
P Малоуглеродистые стали	≤180НВ	60 (50—70)	0.18 (0.13—0.20)	70 (55—80)	0.20 (0.15—0.23)	75 (60—85)	0.25 (0.18—0.28)
	180—280НВ	55 (40—65)	0.15 (0.10—0.18)	65 (45—75)	0.18 (0.13—0.22)	70 (55—80)	0.23 (0.15—0.25)
	280—350НВ	50 (40—60)	0.12 (0.08—0.15)	55 (40—65)	0.17 (0.13—0.20)	60 (40—75)	0.20 (0.15—0.23)
M Нержавеющая сталь	≤200НВ	35 (30—45)	0.10 (0.07—0.15)	40 (30—50)	0.12 (0.08—0.15)	45 (30—60)	0.15 (0.13—0.20)
K Чугун	Предел прочности ≤350МПа	55 (35—70)	0.15 (0.10—0.20)	60 (40—65)	0.20 (0.15—0.23)	60 (45—70)	0.23 (0.18—0.28)
	Предел прочности ≤450МПа	45 (30—60)	0.12 (0.08—0.15)	50 (40—60)	0.17 (0.13—0.20)	55 (40—65)	0.20 (0.15—0.23)
S Жаропрочные сплавы	—	15 (10—25)	0.07 (0.05—0.10)	20 (10—25)	0.07 (0.05—0.10)	20 (10—25)	0.10 (0.06—0.12)

Режимы резания могут быть изменены. Используйте приведенные в таблице значения как первоначальные и корректируйте значения в зависимости от условий обработки.

Для сверл длиной выше L/D=10 рекомендуется просверлить направляющее отверстие.



Пожалуйста, замените все будущие заказы изделий, отмеченных серым цветом (MPS,MSL), на серию MPS1 с немедленным вступлением в силу. Это связано с тем, что производство MPS, MSL будет постепенно прекращаться и остановится в марте 2023 года.

M
**ИНСТРУМЕНТ ДЛЯ
СВЕРЛЕНИЯ**

РУКОВОДСТВО ПО ИСПОЛЬЗОВАНИЮ СЕРИЙ ДЛИННЫХ СВЕРЛ MPS/MSL

СВЕРЛЕНИЕ НА ПЛОСКИХ ПОВЕРХНОСТЯХ ● Сделать глухое отверстие

1. Выполнить направляющее отверстие

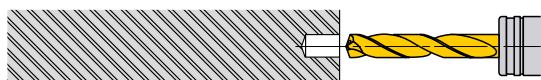

- ① Используйте сверло с большим двойным углом в плане, чем у сверла длинного исполнения. Используйте сверло с минимальной длиной режущей кромки.
- ② Для обеспечения высокой точности отверстия, точно выполняйте направляющее отверстие.
- ③ Глубина сверления: около 1DC или глубже.
(Выберите глубину направляющего отверстия, соответствующую длине сверхдлинного сверла.)

2. Предварительная обработка при помощи длинного сверла.



- ① Вводите сверло в направляющее отверстие при низких оборотах (вращение 1000 мин^{-1} , скорость подачи $0,2-0,3 \text{ мм/об}$).
- ② Остановить сверло для глубоких отверстий $0,5-1 \text{ мм}$ до достижения дна направляющего отверстия.

3. Сверление глубокого отверстия

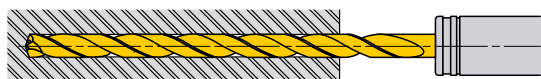

- ① Увеличьте частоту вращения и подачу за цикл и просверлите до желаемой глубины.

4. Отвод сверла из отверстия

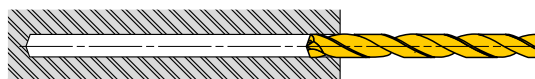

- ① После окончания сверления снизьте обороты, не доходя приблизительно $0,5-1 \text{ мм}$ до конца отверстия (частота вращения около 1000 мин^{-1}).
- ② Выньте сверло примерно до глубины направляющего отверстия ($V_f=3000 \text{ мм/мин.}$)
- ③ Выведите сверло из направляющего отверстия с уменьшенной частотой вращения ($n=300, V_f=3000 \text{ мм/мин}$)

СВЕРЛЕНИЕ НА НАКЛОННЫХ ПОВЕРХНОСТЯХ ● Отверстия на изогнутых заготовках

1. Фрезерование плоских поверхностей



- ① Отфрезеруйте плоскую поверхность на заготовке фрезой, такого же диаметра, что и диаметр желаемого отверстия.

2. Выполнить направляющее отверстие



- ① Используйте сверло с большим двойным углом в плане, чем у сверла длинного исполнения. Используйте сверло с минимальной длиной режущей кромки.
- ② Для обеспечения высокой точности отверстия, точно выполняйте направляющее отверстие.
- ③ Глубина сверления: около 1DC или глубже.
(Выберите глубину направляющего отверстия, соответствующую длине сверхдлинного сверла.)

3. Предварительная обработка при помощи длинного сверла.



- ① Вводите сверло в направляющее отверстие на низких оборотах (частота вращения 1000 мин^{-1} , скорость подачи $0,2-0,3 \text{ мм/об}$).
- ② Остановить длинное сверло за $0,5-1 \text{ мм}$ до достижения дна направляющего отверстия.

4. Сверление глубокого отверстия

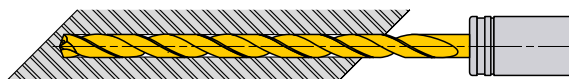

- ① Увеличьте частоту вращения и подачу за цикл и просверлите до желаемой глубины.

5. Проходные отверстия

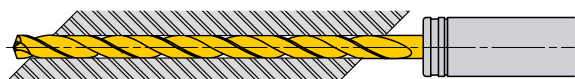

- ① При выходе из заготовки режущая кромка сверла может обломиться.
- ② При выводе сверла в отверстие снизьте скорость подачи.

6. Отвод сверла из отверстия



- ① Обработайте отверстие со скоростью резания $20-30 \text{ м/мин}$ и подачей $0,2-0,3 \text{ мм/об}$.
- ② Поднимите сверло из направляющего отверстия до глубины начальной точки с подачей 3000 мм/мин .



Пожалуйста, замените все будущие заказы изделий, отмеченных серым цветом (MPS,MSL), на серию MPS1 с немедленным вступлением в силу.
Это связано с тем, что производство MPS, MSL будет постепенно прекращаться и остановится в марте 2023 года.

MICRO-MGS

- Возможно глубокое сверление отверстий малого диаметра.
- Практически полное отсутствие радиального биения обеспечивает высокую точность сверления.



ТВЕРДЫЙ СПЛАВ



Внутреннее охлаждение

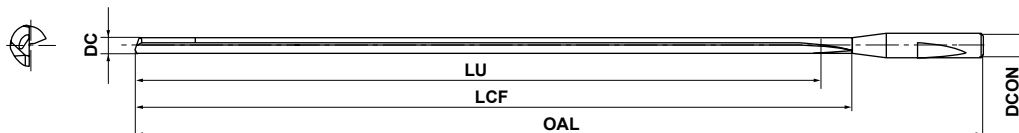

DC ≤ 3
0
-0.005

● Сверла MGS предназначены для использования с термомпатронами.

DC (мм)	Глубина сверления (L/D)	HT110	Обозначение	Размеры (мм)			
				LU	LCF	OAL	DCON
0.7	50	★	MGS0070L040B	35.0	40	80	3
	80	★	MGS0070L060B	56.0	60	100	3
0.8	45	★	MGS0080L040B	36.0	40	80	3
	70	★	MGS0080L060B	56.0	60	100	3
0.9	40	★	MGS0090L040B	36.0	40	80	3
	60	★	MGS0090L060B	54.0	60	100	3
1.0	35	★	MGS0100L040B	35.0	40	80	3
	55	★	MGS0100L060B	55.0	60	100	3
	75	★	MGS0100L080B	75.0	80	120	3
1.1	30	★	MGS0110L040B	33.0	40	80	3
	50	★	MGS0110L060B	55.0	60	100	3
	65	★	MGS0110L080B	71.5	80	120	3
1.2	30	★	MGS0120L040B	36.0	40	80	3
	45	★	MGS0120L060B	54.0	60	100	3
	60	★	MGS0120L080B	72.0	80	120	3
1.3	40	★	MGS0130L060B	52.0	60	100	3
	55	★	MGS0130L080B	71.5	80	120	3
	70	★	MGS0130L100B	91.0	100	140	3
1.4	35	★	MGS0140L060B	49.0	60	100	3
	50	★	MGS0140L080B	70.0	80	120	3
	65	★	MGS0140L100B	91.0	100	140	3
1.5	35	★	MGS0150L060B	52.5	60	100	3
	50	★	MGS0150L080B	75.0	80	120	3
	60	★	MGS0150L100B	90.0	100	140	3
1.6	30	★	MGS0160L060B	48.0	60	100	3
	45	★	MGS0160L080B	72.0	80	120	3
	55	★	MGS0160L100B	88.0	100	140	3
1.7	30	★	MGS0170L060B	51.0	60	100	3
	40	★	MGS0170L080B	68.0	80	120	3
	55	★	MGS0170L100B	93.5	100	140	3

DC (мм)	Глубина сверления (L/D)	HT110	Обозначение	Размеры (мм)			
				LU	LCF	OAL	DCON
1.8	30	★	MGS0180L060B	54.0	60	100	3
	40	★	MGS0180L080B	72.0	80	120	3
	50	★	MGS0180L100B	90.0	100	140	3
1.9	25	★	MGS0190L060B	47.5	60	100	3
	35	★	MGS0190L080B	66.5	80	120	3
	45	★	MGS0190L100B	85.5	100	140	3
2.0	25	★	MGS0200L060B	50.0	60	100	3
	35	★	MGS0200L080B	70.0	80	120	3
	45	★	MGS0200L100B	90.0	100	140	3
2.1	35	★	MGS0210L080B	73.5	80	120	3
	40	★	MGS0210L100B	84.0	100	140	3
2.2	30	★	MGS0220L080B	66.0	80	120	3
	40	★	MGS0220L100B	88.0	100	140	3
2.3	30	★	MGS0230L080B	69.0	80	120	3
	40	★	MGS0230L100B	92.0	100	140	3
2.4	30	★	MGS0240L080B	72.0	80	120	3
	35	★	MGS0240L100B	84.0	100	140	3
2.5	25	★	MGS0250L080B	62.5	80	120	3
	35	★	MGS0250L100B	87.5	100	140	3
2.6	25	★	MGS0260L080B	65.0	80	120	3
	35	★	MGS0260L100B	91.0	100	140	3
2.7	25	★	MGS0270L080B	67.5	80	120	3
	30	★	MGS0270L100B	81.0	100	140	3
2.8	25	★	MGS0280L080B	70.0	80	120	3
	30	★	MGS0280L100B	84.0	100	140	3
2.9	20	★	MGS0290L080B	58.0	80	120	3
	30	★	MGS0290L100B	87.0	100	140	3
3.0	20	★	MGS0300L080B	60.0	80	120	3
	30	★	MGS0300L100B	90.0	100	140	3

Примечание 1) Если Вам необходимы сверла с покрытием, пожалуйста, свяжитесь с нами. (VP, GP и UP твердый сплав с покрытием).

★ : Со склада в Японии.

РЕЖИМЫ РЕЗАНИЯ > L080
ТЕХНИЧЕСКИЕ ДАННЫЕ > P001

M079

ИНСТРУМЕНТ ДЛЯ СВЕРЛЕНИЯ

M

MICRO-MGS

ТВЕРДЫЙ СПЛАВ

■ ПРИВОД

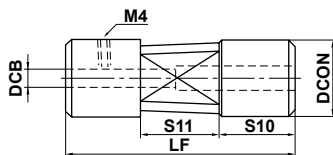

■ ИСПОЛЬЗОВАНИЕ С ПРИВОДОМ

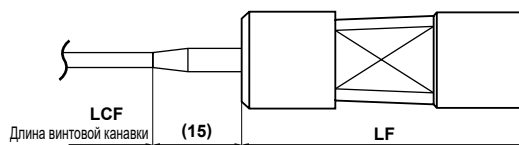

Обозначение	Напильчик	Размеры (мм)						
		DCON	DCB	LF	S10	S11		
MGD38	★	12.7	3.0	38.1	12.6	12.7	HSS04004	HKY20F
MGD70	★	12.7	3.0	70.0	25.0	20.0	HSS04004	HKY20F

РЕКОМЕНДУЕМЫЕ РЕЖИМЫ РЕЗАНИЯ

Обработываемый материал	P					P				
	Малоуглеродистые стали ($\leq 180\text{HB}$)					Углеродистая сталь Легированная сталь ($180-280\text{HB}$)				
Ск10						Ск45, 42CrMo4				
Тип СОЖ	Не растворимая в воде СОЖ					Не растворимая в воде СОЖ				
Диам. сверла DC (мм)	Скорость резания (м/мин)	Частота вращения (мин ⁻¹)	Подача (мин. — макс.) (мм/об)		Подача (мм/мин)	Скорость резания (м/мин)	Частота вращения (мин ⁻¹)	Подача (мин. — макс.) (мм/об)		Подача (мм/мин)
0.8	50	19800	0.01 (0.005—0.016)		195	40	15900	0.01 (0.005—0.016)		155
1.0	50	15900	0.01 (0.007—0.020)		155	40	12700	0.01 (0.007—0.020)		125
1.2	60	15900	0.015 (0.008—0.024)		235	50	13200	0.015 (0.008—0.024)		195
1.6	60	11900	0.02 (0.011—0.032)		235	50	9900	0.02 (0.011—0.032)		195
2.0	60	9500	0.025 (0.013—0.040)		235	50	7900	0.025 (0.013—0.040)		195
2.5	70	8900	0.03 (0.017—0.050)		265	60	7600	0.03 (0.017—0.050)		225
3.0	70	7400	0.04 (0.020—0.060)		295	60	6300	0.04 (0.020—0.060)		250
Обработываемый материал	P					M				
	Углеродистая сталь Легированная сталь ($280-350\text{HB}$)					Аустенитная нержавеющая сталь ($\leq 200\text{HB}$)				
36CrNiMo4						X5CrNi1810, X5CrNiMo17-12-2				
Тип СОЖ	Не растворимая в воде СОЖ					Не растворимая в воде СОЖ				
Диам. сверла DC (мм)	Скорость резания (м/мин)	Частота вращения (мин ⁻¹)	Подача (мин. — макс.) (мм/об)		Подача (мм/мин)	Скорость резания (м/мин)	Частота вращения (мин ⁻¹)	Подача (мин. — макс.) (мм/об)		Подача (мм/мин)
0.8	30	11900	0.005 (0.004—0.005)		55	30	11900	0.01 (0.005—0.016)		115
1.0	30	9500	0.005 (0.005—0.007)		45	30	9500	0.01 (0.007—0.020)		95
1.2	40	10600	0.005 (0.006—0.008)		50	30	7900	0.015 (0.008—0.024)		115
1.6	40	7900	0.01 (0.008—0.011)		75	40	7900	0.02 (0.011—0.032)		155
2.0	40	6300	0.01 (0.010—0.013)		60	40	6300	0.025 (0.013—0.040)		155
2.5	50	6300	0.015 (0.013—0.017)		90	40	5000	0.03 (0.017—0.050)		150
3.0	50	5300	0.015 (0.015—0.020)		75	40	4200	0.04 (0.020—0.060)		165
Обработываемый материал	K					K				
	Серый чугун ($\leq 350\text{МПа}$)					Ковкий чугун ($\leq 450\text{МПа}$)				
GG30						GGG45				
Тип СОЖ	Не растворимая в воде СОЖ • Растворимая в воде СОЖ					Не растворимая в воде СОЖ • Растворимая в воде СОЖ				
Диам. сверла DC (мм)	Скорость резания (м/мин)	Частота вращения (мин ⁻¹)	Подача (мин. — макс.) (мм/об)		Подача (мм/мин)	Скорость резания (м/мин)	Частота вращения (мин ⁻¹)	Подача (мин. — макс.) (мм/об)		Подача (мм/мин)
0.8	50	19800	0.01 (0.008—0.016)		195	40	15900	0.005 (0.005—0.008)		75
1.0	50	15900	0.015 (0.010—0.020)		235	40	12700	0.005 (0.007—0.010)		60
1.2	60	15900	0.015 (0.012—0.024)		235	50	13200	0.01 (0.008—0.012)		130
1.6	60	11900	0.02 (0.016—0.032)		235	50	9900	0.01 (0.011—0.016)		95
2.0	60	9500	0.03 (0.020—0.040)		285	50	7900	0.015 (0.013—0.020)		115
2.5	70	8900	0.035 (0.025—0.050)		310	60	7600	0.02 (0.017—0.025)		150
3.0	70	7400	0.045 (0.030—0.060)		330	60	6300	0.025 (0.020—0.030)		155

Примечание 1) Для обеспечения безопасности и надлежащей работы требуется СОЖ высокого давления. (минимальное давление СОЖ = 70 Бар)
 Примечание 2) Фильтр для СОЖ должен быть не более 5 мкм.

Тонкая фильтрация необходима для того, чтобы предотвратить забивание отверстий в сверле, предназначенных для подвода СОЖ.

Примечание 3) Требуется направляющее отверстие или направляющая втулка.

★ : Со склада в Японии.

РЕКОМЕНДУЕМЫЕ РЕЖИМЫ РЕЗАНИЯ

Обрабатываемый материал	N							
	Алюминиевые сплавы (Si<5%)				Медь, Медный сплав			
Тип СОЖ	Не растворимая в воде СОЖ • Растворимая в воде СОЖ				Не растворимая в воде СОЖ • Растворимая в воде СОЖ			
Диам. сверла DC (мм)	Скорость резания (м/мин)	Частота вращения (мин ⁻¹)	Подача (мин. — макс.) (мм/об)	Подача (мм/мин)	Скорость резания (м/мин)	Частота вращения (мин ⁻¹)	Подача (мин. — макс.) (мм/об)	Подача (мм/мин)
0.8	50	19800	0.01 (0.008—0.016)	195	40	15900	0.01 (0.008—0.016)	155
1.0	60	19000	0.015 (0.010—0.020)	285	50	15900	0.015 (0.010—0.020)	235
1.2	70	18500	0.015 (0.012—0.024)	275	60	15900	0.015 (0.012—0.024)	235
1.6	80	15900	0.02 (0.016—0.032)	315	70	13900	0.02 (0.016—0.032)	275
2.0	90	14300	0.03 (0.020—0.040)	425	80	12700	0.03 (0.020—0.040)	380
2.5	100	12700	0.035 (0.025—0.050)	440	90	11400	0.035 (0.025—0.050)	395
3.0	100	10600	0.045 (0.030—0.060)	475	100	10600	0.045 (0.030—0.060)	475

Примечание 1) Для обеспечения безопасности и надлежащей работы требуется СОЖ высокого давления. (минимальное давление СОЖ = 70 Бар)

Примечание 2) Фильтр для СОЖ должен быть не более 5 мкм.

Тонкая фильтрация необходима для того, чтобы предотвратить забивание отверстий в сверле, предназначенных для подвода СОЖ.

Примечание 3) Требуется направляющее отверстие или направляющая втулка.

РУКОВОДСТВО ДЛЯ ПОЛЬЗОВАНИЯ

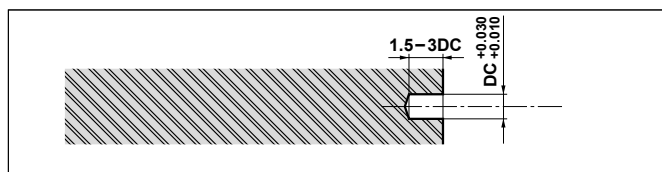

1. Сверление направляющего отверстия.
(Рекомендуется использовать сверла Mitsubishi серии MWE или MWS.)

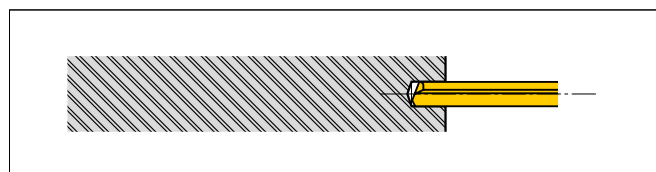

2. Подвести сверло в направляющее отверстие без вращения или с вращением в противоположном направлении при скорости до 300 об/мин. Остановить ружейное сверло MGS, не доходя 1–2 мм до дна направляющего отверстия.

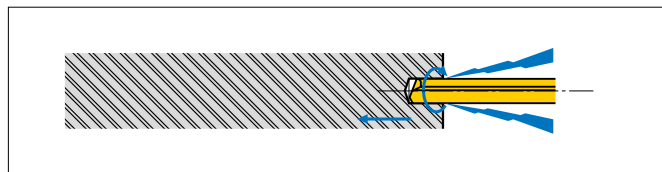

3. Включите подачу СОЖ, повысьте скорость резания и задайте рекомендуемые параметры для подачи. После этого приступите к сверлению.

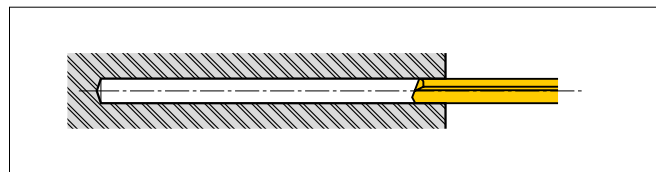

4. После сверления возвратитесь в положение "П. 2", выключите подачу СОЖ и остановите вращение шпинделя.

ИНСТРУМЕНТ ДЛЯ СВЕРЛЕНИЯ (МОНОЛИТНЫЕ ТВЕРДОСПЛАВНЫЕ СВЕРЛА)

MMS

- Для высокоточного и эффективного сверления нержавеющих сталей.
- Тригональные отверстия начиная с диаметра 4.60 мм.



ТВЕРДЫЙ СПЛАВ

P M K N S H

Внутреннее охлаждение



	DC=3	3<DC≤6	6<DC≤10	10<DC≤18	18<DC≤20
DIN Тип (m7)	+0.012 +0.002	+0.016 +0.004	+0.021 +0.006	+0.025 +0.007	+0.029 +0.008
Прочее (h8)	0 -0.014	0 -0.018	0 -0.022	0 -0.027	0 -0.033
h6		0 -0.008	0 -0.009	0 -0.011	0 -0.013

● Тип 1 Цилиндрический тип хвостовика

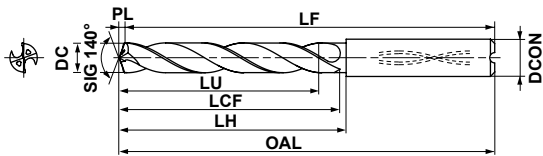

MMS---S/L-DIN-C (L/D 3-5)
MMS---X3/X5DB (L/D 3-5)

● Тип 2 Тип хвостовика Whistle notch

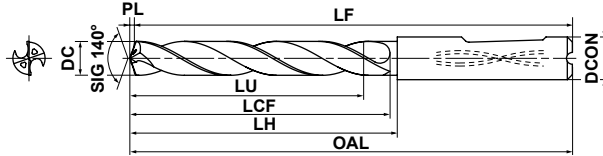

MMS---S/L-DIN (L/D 3-5)

● Тип 3 Цилиндрический тип хвостовика с конической шейкой

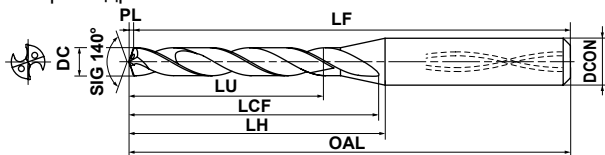

MMS---S/L-DIN-C (L/D 3-5)
MMS---X3/X5DB (L/D 3-5)

● Тип 4 Тип хвостовика Whistle notch с конической шейкой

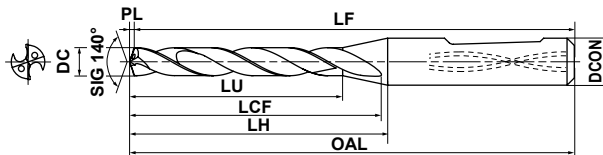

MMS---S/L-DIN (L/D 3-5)

DC (мм)	Глубина сверления (L/D)	DP7020	Обозначение	Размеры (мм)						Тип	
				LU	LCF	LH	OAL	LF	PL		DCON
3.0	3	□	MMS0300S-DIN	15.0	19.5	24.5	61.5	61	0.5	6	4
	3	●	MMS0300S-DIN-C	15.0	19.5	24.5	61.5	61	0.5	6	3
	5	□	MMS0300L-DIN	23.0	27.5	28.5	65.5	65	0.5	6	4
	5	●	MMS0300L-DIN-C	23.0	27.5	28.5	65.5	65	0.5	6	3
	3	★	MMS0300X3DB	9.5	21.5	23.5	70.5	70	0.5	6	3
	5	★	MMS0300X5DB	15.5	28.5	31.5	78.5	78	0.5	6	3
3.05	3	□	MMS0305S-DIN	15.0	19.6	24.6	61.6	61	0.6	6	4
	3	●	MMS0305S-DIN-C	15.0	19.6	24.6	61.6	61	0.6	6	3
	5	□	MMS0305L-DIN	23.0	27.6	28.6	65.6	65	0.6	6	4
	5	●	MMS0305L-DIN-C	23.0	27.6	28.6	65.6	65	0.6	6	3
3.1	3	□	MMS0310S-DIN	14.9	19.6	24.6	61.6	61	0.6	6	4
	3	●	MMS0310S-DIN-C	14.9	19.6	24.6	61.6	61	0.6	6	3
	5	□	MMS0310L-DIN	22.9	27.6	28.6	65.6	65	0.6	6	4
	5	●	MMS0310L-DIN-C	22.9	27.6	28.6	65.6	65	0.6	6	3
	3	★	MMS0310X3DB	9.9	21.6	23.6	70.6	70	0.6	6	3
	5	★	MMS0310X5DB	16.1	28.6	31.6	78.6	78	0.6	6	3
3.2	3	□	MMS0320S-DIN	14.8	19.6	24.6	61.6	61	0.6	6	4
	3	●	MMS0320S-DIN-C	14.8	19.6	24.6	61.6	61	0.6	6	3
	5	□	MMS0320L-DIN	22.8	27.6	28.6	65.6	65	0.6	6	4
	5	●	MMS0320L-DIN-C	22.8	27.6	28.6	65.6	65	0.6	6	3
	3	★	MMS0320X3DB	10.2	21.6	23.6	70.6	70	0.6	6	3
	5	★	MMS0320X5DB	16.6	28.6	31.6	78.6	78	0.6	6	3
3.3	3	□	MMS0330S-DIN	14.7	19.6	24.6	61.6	61	0.6	6	4
	3	●	MMS0330S-DIN-C	14.7	19.6	24.6	61.6	61	0.6	6	3
	5	□	MMS0330L-DIN	22.7	27.6	28.6	65.6	65	0.6	6	4
	5	●	MMS0330L-DIN-C	22.7	27.6	28.6	65.6	65	0.6	6	3
	3	★	MMS0330X3DB	10.5	21.6	23.6	70.6	70	0.6	6	3
	5	★	MMS0330X5DB	17.1	28.6	31.6	78.6	78	0.6	6	3
3.4	3	□	MMS0340S-DIN	14.5	19.6	24.6	61.6	61	0.6	6	4
	3	●	MMS0340S-DIN-C	14.5	19.6	24.6	61.6	61	0.6	6	3
	5	□	MMS0340L-DIN	22.5	27.6	28.6	65.6	65	0.6	6	4
	5	●	MMS0340L-DIN-C	22.5	27.6	28.6	65.6	65	0.6	6	3

DC (мм)	Глубина сверления (L/D)	DP7020	Обозначение	Размеры (мм)						Тип	
				LU	LCF	LH	OAL	LF	PL		DCON
3.4	3	★	MMS0340X3DB	10.8	21.6	23.6	70.6	70	0.6	6	3
	5	★	MMS0340X5DB	17.6	28.6	31.6	78.6	78	0.6	6	3
3.5	3	□	MMS0350S-DIN	14.4	19.6	24.6	61.6	61	0.6	6	4
	3	●	MMS0350S-DIN-C	14.4	19.6	24.6	61.6	61	0.6	6	3
	5	□	MMS0350L-DIN	22.4	27.6	28.6	65.6	65	0.6	6	4
	5	●	MMS0350L-DIN-C	22.4	27.6	28.6	65.6	65	0.6	6	3
	3	★	MMS0350X3DB	11.1	21.6	23.6	70.6	70	0.6	6	3
	5	★	MMS0350X5DB	18.1	28.6	31.6	78.6	78	0.6	6	3
3.6	3	□	MMS0360S-DIN	14.3	19.7	24.7	61.7	61	0.7	6	4
	3	●	MMS0360S-DIN-C	14.3	19.7	24.7	61.7	61	0.7	6	3
	5	□	MMS0360L-DIN	22.3	27.7	28.7	65.7	65	0.7	6	4
	5	●	MMS0360L-DIN-C	22.3	27.7	28.7	65.7	65	0.7	6	3
	3	★	MMS0360X3DB	11.5	22.7	23.7	70.7	70	0.7	6	3
	5	★	MMS0360X5DB	18.7	30.7	31.7	78.7	78	0.7	6	3
3.7	3	□	MMS0370S-DIN	14.1	19.7	24.7	61.7	61	0.7	6	4
	3	●	MMS0370S-DIN-C	14.1	19.7	24.7	61.7	61	0.7	6	3
	5	□	MMS0370L-DIN	22.1	27.7	28.7	65.7	65	0.7	6	4
	5	●	MMS0370L-DIN-C	22.1	27.7	28.7	65.7	65	0.7	6	3
	3	★	MMS0370X3DB	11.8	22.7	23.7	70.7	70	0.7	6	3
	5	★	MMS0370X5DB	19.2	30.7	31.7	78.7	78	0.7	6	3
3.8	3	□	MMS0380S-DIN	18.0	23.7	28.7	65.7	65	0.7	6	4
	3	●	MMS0380S-DIN-C	18.0	23.7	28.7	65.7	65	0.7	6	3
	5	□	MMS0380L-DIN	30.0	35.7	36.7	73.7	73	0.7	6	4
	5	●	MMS0380L-DIN-C	30.0	35.7	36.7	73.7	73	0.7	6	3
	3	★	MMS0380X3DB	12.1	22.7	23.7	70.7	70	0.7	6	3
	5	★	MMS0380X5DB	19.7	30.7	31.7	78.7	78	0.7	6	3
3.9	3	□	MMS0390S-DIN	17.9	23.7	28.7	65.7	65	0.7	6	4
	3	●	MMS0390S-DIN-C	17.9	23.7	28.7	65.7	65	0.7	6	3
	5	□	MMS0390L-DIN	29.9	35.7	36.7	73.7	73	0.7	6	4
	5	●	MMS0390L-DIN-C	29.9	35.7	36.7	73.7	73	0.7	6	3
	3	★	MMS0390X3DB	12.4	22.7	23.7	70.7	70	0.7	6	3
	5	★	MMS0390X5DB	20.2	30.7	31.7	78.7	78	0.7	6	3

● : Есть на складе. ★ : Со склада в Японии.

□ : Нет на складе, выпускается исключительно под заказ.

DC (мм)	Глубина сверления (L/D)	DP7020	Обозначение	Размеры (мм)							Тип
				LU	LCF	LH	OAL	LF	PL	DCON	
4.0	3	□	MMS0400S-DIN	17.7	23.7	28.7	65.7	65	0.7	6	4
	3	●	MMS0400S-DIN-C	17.7	23.7	28.7	65.7	65	0.7	6	3
	5	□	MMS0400L-DIN	29.7	35.7	36.7	73.7	73	0.7	6	4
	5	●	MMS0400L-DIN-C	29.7	35.7	36.7	73.7	73	0.7	6	3
	3	★	MMS0400X3DB	12.7	22.7	23.7	70.7	70	0.7	6	3
	5	★	MMS0400X5DB	20.7	30.7	31.7	78.7	78	0.7	6	3
4.05	3	□	MMS0405S-DIN	17.7	23.7	28.7	65.7	65	0.7	6	4
	3	●	MMS0405S-DIN-C	17.7	23.7	28.7	65.7	65	0.7	6	3
	5	□	MMS0405L-DIN	29.7	35.7	36.7	73.7	73	0.7	6	4
	5	●	MMS0405L-DIN-C	29.7	35.7	36.7	73.7	73	0.7	6	3
4.1	3	□	MMS0410S-DIN	17.6	23.7	28.7	65.7	65	0.7	6	4
	3	●	MMS0410S-DIN-C	17.6	23.7	28.7	65.7	65	0.7	6	3
	5	□	MMS0410L-DIN	29.6	35.7	36.7	73.7	73	0.7	6	4
	5	●	MMS0410L-DIN-C	29.6	35.7	36.7	73.7	73	0.7	6	3
	3	★	MMS0410X3DB	13.0	24.7	26.7	73.7	73	0.7	6	3
5	★	MMS0410X5DB	21.2	33.7	35.7	82.7	82	0.7	6	3	
4.2	3	□	MMS0420S-DIN	17.5	23.8	28.8	65.8	65	0.8	6	4
	3	●	MMS0420S-DIN-C	17.5	23.8	28.8	65.8	65	0.8	6	3
	5	□	MMS0420L-DIN	29.5	35.8	36.8	73.8	73	0.8	6	4
	5	●	MMS0420L-DIN-C	29.5	35.8	36.8	73.8	73	0.8	6	3
	3	★	MMS0420X3DB	13.4	24.8	26.8	73.8	73	0.8	6	3
5	★	MMS0420X5DB	21.8	33.8	35.8	82.8	82	0.8	6	3	
4.3	3	□	MMS0430S-DIN	17.3	23.8	28.8	65.8	65	0.8	6	4
	3	●	MMS0430S-DIN-C	17.3	23.8	28.8	65.8	65	0.8	6	3
	5	□	MMS0430L-DIN	29.3	35.8	36.8	73.8	73	0.8	6	4
	5	●	MMS0430L-DIN-C	29.3	35.8	36.8	73.8	73	0.8	6	3
	3	★	MMS0430X3DB	13.7	24.8	26.8	73.8	73	0.8	6	3
	5	★	MMS0430X5DB	22.3	33.8	35.8	82.8	82	0.8	6	3
4.4	3	□	MMS0440S-DIN	17.2	23.8	28.8	65.8	65	0.8	6	4
	3	●	MMS0440S-DIN-C	17.2	23.8	28.8	65.8	65	0.8	6	3
	5	□	MMS0440L-DIN	29.2	35.8	36.8	73.8	73	0.8	6	4
	5	●	MMS0440L-DIN-C	29.2	35.8	36.8	73.8	73	0.8	6	3
	3	★	MMS0440X3DB	14.0	24.8	26.8	73.8	73	0.8	6	3
	5	★	MMS0440X5DB	22.8	33.8	35.8	82.8	82	0.8	6	3
4.5	3	□	MMS0450S-DIN	17.1	23.8	28.8	65.8	65	0.8	6	4
	3	●	MMS0450S-DIN-C	17.1	23.8	28.8	65.8	65	0.8	6	3
	5	□	MMS0450L-DIN	29.1	35.8	36.8	73.8	73	0.8	6	4
	5	●	MMS0450L-DIN-C	29.1	35.8	36.8	73.8	73	0.8	6	3
	3	★	MMS0450X3DB	14.3	24.8	26.8	73.8	73	0.8	6	3
	5	★	MMS0450X5DB	23.3	33.8	35.8	82.8	82	0.8	6	3
4.6	3	□	MMS0460S-DIN	16.9	23.8	28.8	65.8	65	0.8	6	2
	3	●	MMS0460S-DIN-C	16.9	23.8	28.8	65.8	65	0.8	6	1
	5	□	MMS0460L-DIN	28.9	35.8	36.8	73.8	73	0.8	6	2
	5	●	MMS0460L-DIN-C	28.9	35.8	36.8	73.8	73	0.8	6	1
	3	★	MMS0460X3DB	14.6	25.8	28.8	75.8	75	0.8	6	1
	5	★	MMS0460X5DB	23.8	35.8	38.8	85.8	85	0.8	6	1
4.65	3	□	MMS0465S-DIN	16.9	23.8	28.8	65.8	65	0.8	6	2
	3	●	MMS0465S-DIN-C	16.9	23.8	28.8	65.8	65	0.8	6	1
	5	□	MMS0465L-DIN	28.9	35.8	36.8	73.8	73	0.8	6	2
	5	●	MMS0465L-DIN-C	28.9	35.8	36.8	73.8	73	0.8	6	1

DC (мм)	Глубина сверления (L/D)	DP7020	Обозначение	Размеры (мм)							Тип
				LU	LCF	LH	OAL	LF	PL	DCON	
4.7	3	□	MMS0470S-DIN	16.8	23.9	28.9	65.9	65	0.9	6	2
	3	●	MMS0470S-DIN-C	16.8	23.9	28.9	65.9	65	0.9	6	1
	5	□	MMS0470L-DIN	28.8	35.9	36.9	73.9	73	0.9	6	2
	5	●	MMS0470L-DIN-C	28.8	35.9	36.9	73.9	73	0.9	6	1
	3	★	MMS0470X3DB	15.0	25.9	28.9	75.9	75	0.9	6	1
	5	★	MMS0470X5DB	24.4	35.9	38.9	85.9	85	0.9	6	1
4.8	3	□	MMS0480S-DIN	20.7	27.9	28.9	65.9	65	0.9	6	2
	3	●	MMS0480S-DIN-C	20.7	27.9	28.9	65.9	65	0.9	6	1
	5	□	MMS0480L-DIN	36.7	43.9	44.9	81.9	81	0.9	6	2
	5	●	MMS0480L-DIN-C	36.7	43.9	44.9	81.9	81	0.9	6	1
	3	★	MMS0480X3DB	15.3	25.9	28.9	75.9	75	0.9	6	1
	5	★	MMS0480X5DB	24.9	35.9	38.9	85.9	85	0.9	6	1
4.9	3	□	MMS0490S-DIN	20.5	27.9	28.9	65.9	65	0.9	6	2
	3	●	MMS0490S-DIN-C	20.5	27.9	28.9	65.9	65	0.9	6	1
	5	□	MMS0490L-DIN	36.5	43.9	44.9	81.9	81	0.9	6	2
	5	●	MMS0490L-DIN-C	36.5	43.9	44.9	81.9	81	0.9	6	1
	3	★	MMS0490X3DB	15.6	25.9	28.9	75.9	75	0.9	6	1
	5	★	MMS0490X5DB	25.4	35.9	38.9	85.9	85	0.9	6	1
5.0	3	□	MMS0500S-DIN	20.4	27.9	28.9	65.9	65	0.9	6	2
	3	●	MMS0500S-DIN-C	20.4	27.9	28.9	65.9	65	0.9	6	1
	5	□	MMS0500L-DIN	36.4	43.9	44.9	81.9	81	0.9	6	2
	5	●	MMS0500L-DIN-C	36.4	43.9	44.9	81.9	81	0.9	6	1
	3	★	MMS0500X3DB	15.9	25.9	28.9	75.9	75	0.9	6	1
	5	★	MMS0500X5DB	25.9	35.9	38.9	85.9	85	0.9	6	1
5.05	3	□	MMS0505S-DIN	20.3	27.9	28.9	65.9	65	0.9	6	2
	3	●	MMS0505S-DIN-C	20.3	27.9	28.9	65.9	65	0.9	6	1
	5	□	MMS0505L-DIN	36.3	43.9	44.9	81.9	81	0.9	6	2
5	●	MMS0505L-DIN-C	36.3	43.9	44.9	81.9	81	0.9	6	1	
5.1	3	□	MMS0510S-DIN	20.3	27.9	28.9	65.9	65	0.9	6	2
	3	●	MMS0510S-DIN-C	20.3	27.9	28.9	65.9	65	0.9	6	1
	5	□	MMS0510L-DIN	36.3	43.9	44.9	81.9	81	0.9	6	2
	5	●	MMS0510L-DIN-C	36.3	43.9	44.9	81.9	81	0.9	6	1
	3	★	MMS0510X3DB	16.2	28.9	30.9	81.9	81	0.9	6	1
	5	★	MMS0510X5DB	26.4	39.9	42.9	89.9	89	0.9	6	1
5.2	3	□	MMS0520S-DIN	20.1	27.9	28.9	65.9	65	0.9	6	2
	3	●	MMS0520S-DIN-C	20.1	27.9	28.9	65.9	65	0.9	6	1
	5	□	MMS0520L-DIN	36.1	43.9	44.9	81.9	81	0.9	6	2
	5	●	MMS0520L-DIN-C	36.1	43.9	44.9	81.9	81	0.9	6	1
	3	★	MMS0520X3DB	16.5	28.9	30.9	81.9	81	0.9	6	1
	5	★	MMS0520X5DB	26.9	39.9	42.9	89.9	89	0.9	6	1
5.3	3	□	MMS0530S-DIN	20.0	28.0	29.0	66.0	65	1.0	6	2
	3	●	MMS0530S-DIN-C	20.0	28.0	29.0	66.0	65	1.0	6	1
	5	□	MMS0530L-DIN	36.0	44.0	45.0	82.0	81	1.0	6	2
	5	●	MMS0530L-DIN-C	36.0	44.0	45.0	82.0	81	1.0	6	1
	3	★	MMS0530X3DB	16.9	29.0	31.0	82.0	81	1.0	6	1
	5	★	MMS0530X5DB	27.5	40.0	43.0	90.0	89	1.0	6	1
5.4	3	□	MMS0540S-DIN	19.9	28.0	29.0	66.0	65	1.0	6	2
	3	●	MMS0540S-DIN-C	19.9	28.0	29.0	66.0	65	1.0	6	1
	5	□	MMS0540L-DIN	35.9	44.0	45.0	82.0	81	1.0	6	2
	5	●	MMS0540L-DIN-C	35.9	44.0	45.0	82.0	81	1.0	6	1
	3	★	MMS0540X3DB	17.2	29.0	31.0	82.0	81	1.0	6	1
	5	★	MMS0540X5DB	28.0	40.0	43.0	90.0	89	1.0	6	1

ИНСТРУМЕНТ ДЛЯ СВЕРЛЕНИЯ (МОНОЛИТНЫЕ ТВЕРДОСПЛАВНЫЕ СВЕРЛА)

MMS

ТВЕРДЫЙ СПЛАВ

ИНСТРУМЕНТ ДЛЯ СВЕРЛЕНИЯ

M

DC (мм)	Глубина сверления (L/D)	DP7020	Обозначение	Размеры (мм)							Тип
				LU	LCF	LH	OAL	LF	PL	DCON	
5.5	3	□	MMS0550S-DIN	19.8	28.0	29.0	66.0	65	1.0	6	2
	3	●	MMS0550S-DIN-C	19.8	28.0	29.0	66.0	65	1.0	6	1
	5	□	MMS0550L-DIN	35.8	44.0	45.0	82.0	81	1.0	6	2
	5	●	MMS0550L-DIN-C	35.8	44.0	45.0	82.0	81	1.0	6	1
	3	★	MMS0550X3DB	17.5	29.0	31.0	82.0	81	1.0	6	1
	5	★	MMS0550X5DB	28.5	40.0	43.0	90.0	89	1.0	6	1
5.55	3	□	MMS0555S-DIN	19.7	28.0	29.0	66.0	65	1.0	6	2
	3	●	MMS0555S-DIN-C	19.7	28.0	29.0	66.0	65	1.0	6	1
	5	●	MMS0555L-DIN-C	35.7	44.0	45.0	82.0	81	1.0	6	1
5.6	3	□	MMS0560S-DIN	19.6	28.0	29.0	66.0	65	1.0	6	2
	3	●	MMS0560S-DIN-C	19.6	28.0	29.0	66.0	65	1.0	6	1
	5	□	MMS0560L-DIN	35.6	44.0	45.0	82.0	81	1.0	6	2
	5	●	MMS0560L-DIN-C	35.6	44.0	45.0	82.0	81	1.0	6	1
	3	★	MMS0560X3DB	17.8	31.0	31.0	82.0	81	1.0	6	1
	5	★	MMS0560X5DB	29.0	43.0	43.0	90.0	89	1.0	6	1
5.7	3	□	MMS0570S-DIN	19.5	28.0	29.0	66.0	65	1.0	6	2
	3	●	MMS0570S-DIN-C	19.5	28.0	29.0	66.0	65	1.0	6	1
	5	□	MMS0570L-DIN	35.5	44.0	45.0	82.0	81	1.0	6	2
	5	●	MMS0570L-DIN-C	35.5	44.0	45.0	82.0	81	1.0	6	1
	3	★	MMS0570X3DB	18.1	31.0	31.0	82.0	81	1.0	6	1
	5	★	MMS0570X5DB	29.5	43.0	43.0	90.0	89	1.0	6	1
5.8	3	□	MMS0580S-DIN	19.4	28.1	29.1	66.1	65	1.1	6	2
	3	●	MMS0580S-DIN-C	19.4	28.1	29.1	66.1	65	1.1	6	1
	5	□	MMS0580L-DIN	35.4	44.1	45.1	82.1	81	1.1	6	2
	5	●	MMS0580L-DIN-C	35.4	44.1	45.1	82.1	81	1.1	6	1
	3	★	MMS0580X3DB	18.5	31.1	31.1	82.1	81	1.1	6	1
	5	★	MMS0580X5DB	30.1	43.1	43.1	90.1	89	1.1	6	1
5.9	3	□	MMS0590S-DIN	19.2	28.1	29.1	66.1	65	1.1	6	2
	3	□	MMS0590S-DIN-C	19.2	28.1	29.1	66.1	65	1.1	6	1
	5	□	MMS0590L-DIN	35.2	44.1	45.1	82.1	81	1.1	6	2
	5	□	MMS0590L-DIN-C	35.2	44.1	45.1	82.1	81	1.1	6	1
	3	★	MMS0590X3DB	18.8	31.1	31.1	82.1	81	1.1	6	1
	5	★	MMS0590X5DB	30.6	43.1	43.1	90.1	89	1.1	6	1
6.0	3	□	MMS0600S-DIN	19.1	28.1	29.1	66.1	65	1.1	6	2
	3	●	MMS0600S-DIN-C	19.1	28.1	29.1	66.1	65	1.1	6	1
	5	□	MMS0600L-DIN	35.1	44.1	45.1	82.1	81	1.1	6	2
	5	●	MMS0600L-DIN-C	35.1	44.1	45.1	82.1	81	1.1	6	1
	3	★	MMS0600X3DB	19.1	31.1	31.1	82.1	81	1.1	6	1
	5	★	MMS0600X5DB	31.1	43.1	43.1	90.1	89	1.1	6	1
6.05	3	□	MMS0605S-DIN	25.0	34.1	42.1	79.1	78	1.1	8	2
	3	●	MMS0605S-DIN-C	25.0	34.1	42.1	79.1	78	1.1	8	1
	5	□	MMS0605L-DIN	44.0	53.1	54.1	91.1	90	1.1	8	2
	5	●	MMS0605L-DIN-C	44.0	53.1	54.1	91.1	90	1.1	8	1
6.1	3	□	MMS0610S-DIN	25.0	34.1	42.1	79.1	78	1.1	8	2
	3	●	MMS0610S-DIN-C	25.0	34.1	42.1	79.1	78	1.1	8	1
	5	□	MMS0610L-DIN	44.0	53.1	54.1	91.1	90	1.1	8	2
	5	●	MMS0610L-DIN-C	44.0	53.1	54.1	91.1	90	1.1	8	1
	3	★	MMS0610X3DB	19.4	34.1	36.1	87.1	86	1.1	8	1
	5	★	MMS0610X5DB	31.6	47.1	49.1	96.1	95	1.1	8	1

DC (мм)	Глубина сверления (L/D)	DP7020	Обозначение	Размеры (мм)							Тип
				LU	LCF	LH	OAL	LF	PL	DCON	
6.2	3	□	MMS0620S-DIN	24.8	34.1	42.1	79.1	78	1.1	8	2
	3	●	MMS0620S-DIN-C	24.8	34.1	42.1	79.1	78	1.1	8	1
	5	□	MMS0620L-DIN	43.8	53.1	54.1	91.1	90	1.1	8	2
	5	●	MMS0620L-DIN-C	43.8	53.1	54.1	91.1	90	1.1	8	1
	3	★	MMS0620X3DB	19.7	34.1	36.1	87.1	86	1.1	8	1
	5	★	MMS0620X5DB	32.1	47.1	49.1	96.1	95	1.1	8	1
6.3	3	□	MMS0630S-DIN	24.7	34.1	42.1	79.1	78	1.1	8	2
	3	□	MMS0630S-DIN-C	24.7	34.1	42.1	79.1	78	1.1	8	1
	5	□	MMS0630L-DIN	43.7	53.1	54.1	91.1	90	1.1	8	2
	5	□	MMS0630L-DIN-C	43.7	53.1	54.1	91.1	90	1.1	8	1
	3	★	MMS0630X3DB	20.0	34.1	36.1	87.1	86	1.1	8	1
	5	★	MMS0630X5DB	32.6	47.1	49.1	96.1	95	1.1	8	1
6.4	3	□	MMS0640S-DIN	24.6	34.2	42.2	79.2	78	1.2	8	2
	3	□	MMS0640S-DIN-C	24.6	34.2	42.2	79.2	78	1.2	8	1
	5	□	MMS0640L-DIN	43.6	53.2	54.2	91.2	90	1.2	8	2
	5	□	MMS0640L-DIN-C	43.6	53.2	54.2	91.2	90	1.2	8	1
	3	★	MMS0640X3DB	20.4	34.2	36.2	87.2	86	1.2	8	1
	5	★	MMS0640X5DB	33.2	47.2	49.2	96.2	95	1.2	8	1
6.5	3	□	MMS0650S-DIN	24.4	34.2	42.2	79.2	78	1.2	8	2
	3	●	MMS0650S-DIN-C	24.4	34.2	42.2	79.2	78	1.2	8	1
	5	□	MMS0650L-DIN	43.4	53.2	54.2	91.2	90	1.2	8	2
	5	●	MMS0650L-DIN-C	43.4	53.2	54.2	91.2	90	1.2	8	1
	3	★	MMS0650X3DB	20.7	34.2	36.2	87.2	86	1.2	8	1
	5	★	MMS0650X5DB	33.7	47.2	49.2	96.2	95	1.2	8	1
6.6	3	□	MMS0660S-DIN	24.3	34.2	42.2	79.2	78	1.2	8	2
	3	●	MMS0660S-DIN-C	24.3	34.2	42.2	79.2	78	1.2	8	1
	5	□	MMS0660L-DIN	43.3	53.2	54.2	91.2	90	1.2	8	2
	5	●	MMS0660L-DIN-C	43.3	53.2	54.2	91.2	90	1.2	8	1
	3	★	MMS0660X3DB	21.0	36.2	38.2	91.2	90	1.2	8	1
	5	★	MMS0660X5DB	34.2	50.2	52.2	99.2	98	1.2	8	1
6.7	3	□	MMS0670S-DIN	24.2	34.2	42.2	79.2	78	1.2	8	2
	3	□	MMS0670S-DIN-C	24.2	34.2	42.2	79.2	78	1.2	8	1
	5	□	MMS0670L-DIN	43.2	53.2	54.2	91.2	90	1.2	8	2
	5	□	MMS0670L-DIN-C	43.2	53.2	54.2	91.2	90	1.2	8	1
	3	★	MMS0670X3DB	21.3	36.2	38.2	91.2	90	1.2	8	1
	5	★	MMS0670X5DB	34.7	50.2	52.2	99.2	98	1.2	8	1
6.8	3	□	MMS0680S-DIN	24.0	34.2	42.2	79.2	78	1.2	8	2
	3	●	MMS0680S-DIN-C	24.0	34.2	42.2	79.2	78	1.2	8	1
	5	□	MMS0680L-DIN	43.0	53.2	54.2	91.2	90	1.2	8	2
	5	●	MMS0680L-DIN-C	43.0	53.2	54.2	91.2	90	1.2	8	1
	3	★	MMS0680X3DB	21.6	36.2	38.2	91.2	90	1.2	8	1
	5	★	MMS0680X5DB	35.2	50.2	52.2	99.2	98	1.2	8	1
6.9	3	□	MMS0690S-DIN	23.9	34.3	42.3	79.3	78	1.3	8	2
	3	●	MMS0690S-DIN-C	23.9	34.3	42.3	79.3	78	1.3	8	1
	5	□	MMS0690L-DIN	42.9	53.3	54.3	91.3	90	1.3	8	2
	5	●	MMS0690L-DIN-C	42.9	53.3	54.3	91.3	90	1.3	8	1
	3	★	MMS0690X3DB	22.0	36.3	38.3	91.3	90	1.3	8	1
	5	★	MMS0690X5DB	35.8	50.3	52.3	99.3	98	1.3	8	1

● : Есть на складе. ★ : Со склада в Японии.

□ : Нет на складе, выпускается исключительно под заказ.

DC (мм)	Глубина сверления (L/D)	DP7020	Обозначение	Размеры (мм)							Тип
				LU	LCF	LH	OAL	LF	PL	DCON	
7.0	3	□	MMS0700S-DIN	23.8	34.3	42.3	79.3	78	1.3	8	2
	3	●	MMS0700S-DIN-C	23.8	34.3	42.3	79.3	78	1.3	8	1
	5	□	MMS0700L-DIN	42.8	53.3	54.3	91.3	90	1.3	8	2
	5	●	MMS0700L-DIN-C	42.8	53.3	54.3	91.3	90	1.3	8	1
	3	★	MMS0700X3DB	22.3	36.3	38.3	91.3	90	1.3	8	1
	5	★	MMS0700X5DB	36.3	50.3	52.3	99.3	98	1.3	8	1
7.1	3	□	MMS0710S-DIN	30.6	41.3	42.3	79.3	78	1.3	8	2
	3	□	MMS0710S-DIN-C	30.6	41.3	42.3	79.3	78	1.3	8	1
	5	□	MMS0710L-DIN	42.6	53.3	54.3	91.3	90	1.3	8	2
	5	□	MMS0710L-DIN-C	42.6	53.3	54.3	91.3	90	1.3	8	1
	3	★	MMS0710X3DB	22.6	39.3	40.3	91.3	90	1.3	8	1
	5	★	MMS0710X5DB	36.8	54.3	57.3	104.3	103	1.3	8	1
7.2	3	□	MMS0720S-DIN	30.5	41.3	42.3	79.3	78	1.3	8	2
	3	□	MMS0720S-DIN-C	30.5	41.3	42.3	79.3	78	1.3	8	1
	5	□	MMS0720L-DIN	42.5	53.3	54.3	91.3	90	1.3	8	2
	5	□	MMS0720L-DIN-C	42.5	53.3	54.3	91.3	90	1.3	8	1
	3	★	MMS0720X3DB	22.9	39.3	40.3	91.3	90	1.3	8	1
	5	★	MMS0720X5DB	37.3	54.3	57.3	104.3	103	1.3	8	1
7.3	3	□	MMS0730S-DIN	30.4	41.3	42.3	79.3	78	1.3	8	2
	3	●	MMS0730S-DIN-C	30.4	41.3	42.3	79.3	78	1.3	8	1
	5	□	MMS0730L-DIN	42.4	53.3	54.3	91.3	90	1.3	8	2
	5	●	MMS0730L-DIN-C	42.4	53.3	54.3	91.3	90	1.3	8	1
	3	★	MMS0730X3DB	23.2	39.3	40.3	91.3	90	1.3	8	1
	5	★	MMS0730X5DB	37.8	54.3	57.3	104.3	103	1.3	8	1
7.4	3	□	MMS0740S-DIN	30.2	41.3	42.3	79.3	78	1.3	8	2
	3	●	MMS0740S-DIN-C	30.2	41.3	42.3	79.3	78	1.3	8	1
	5	□	MMS0740L-DIN	42.2	53.3	54.3	91.3	90	1.3	8	2
	5	●	MMS0740L-DIN-C	42.2	53.3	54.3	91.3	90	1.3	8	1
	3	★	MMS0740X3DB	23.5	39.3	40.3	91.3	90	1.3	8	1
	5	★	MMS0740X5DB	38.3	54.3	57.3	104.3	103	1.3	8	1
7.5	3	□	MMS0750S-DIN	30.1	41.4	42.4	79.4	78	1.4	8	2
	3	●	MMS0750S-DIN-C	30.1	41.4	42.4	79.4	78	1.4	8	1
	5	□	MMS0750L-DIN	42.1	53.4	54.4	91.4	90	1.4	8	2
	5	●	MMS0750L-DIN-C	42.1	53.4	54.4	91.4	90	1.4	8	1
	3	★	MMS0750X3DB	23.9	39.4	40.4	91.4	90	1.4	8	1
	5	★	MMS0750X5DB	38.9	54.4	57.4	104.4	103	1.4	8	1
7.6	3	□	MMS0760S-DIN	30.0	41.4	42.4	79.4	78	1.4	8	2
	3	□	MMS0760S-DIN-C	30.0	41.4	42.4	79.4	78	1.4	8	1
	5	□	MMS0760L-DIN	42.0	53.4	54.4	91.4	90	1.4	8	2
	5	□	MMS0760L-DIN-C	42.0	53.4	54.4	91.4	90	1.4	8	1
	3	★	MMS0760X3DB	24.2	41.4	41.4	91.4	90	1.4	8	1
	5	★	MMS0760X5DB	39.4	57.4	57.4	104.4	103	1.4	8	1
7.7	3	□	MMS0770S-DIN	29.9	41.4	42.4	79.4	78	1.4	8	2
	3	□	MMS0770S-DIN-C	29.9	41.4	42.4	79.4	78	1.4	8	1
	5	□	MMS0770L-DIN	41.9	53.4	54.4	91.4	90	1.4	8	2
	5	□	MMS0770L-DIN-C	41.9	53.4	54.4	91.4	90	1.4	8	1
	3	★	MMS0770X3DB	24.5	41.4	41.4	91.4	90	1.4	8	1
	5	★	MMS0770X5DB	39.9	57.4	57.4	104.4	103	1.4	8	1

DC (мм)	Глубина сверления (L/D)	DP7020	Обозначение	Размеры (мм)							Тип	
				LU	LCF	LH	OAL	LF	PL	DCON		
7.8	3	□	MMS0780S-DIN	29.7	41.4	42.4	79.4	78	1.4	8	2	
	3	●	MMS0780S-DIN-C	29.7	41.4	42.4	79.4	78	1.4	8	1	
	5	□	MMS0780L-DIN	41.7	53.4	54.4	91.4	90	1.4	8	2	
	5	●	MMS0780L-DIN-C	41.7	53.4	54.4	91.4	90	1.4	8	1	
	3	★	MMS0780X3DB	24.8	41.4	41.4	91.4	90	1.4	8	1	
	5	★	MMS0780X5DB	40.4	57.4	57.4	104.4	103	1.4	8	1	
7.9	3	□	MMS0790S-DIN	29.6	41.4	42.4	79.4	78	1.4	8	2	
	3	□	MMS0790S-DIN-C	29.6	41.4	42.4	79.4	78	1.4	8	1	
	5	□	MMS0790L-DIN	41.6	53.4	54.4	91.4	90	1.4	8	2	
	5	□	MMS0790L-DIN-C	41.6	53.4	54.4	91.4	90	1.4	8	1	
	3	★	MMS0790X3DB	25.1	41.4	41.4	91.4	90	1.4	8	1	
	5	★	MMS0790X5DB	40.9	57.4	57.4	104.4	103	1.4	8	1	
8.0	3	□	MMS0800S-DIN	29.5	41.5	42.5	79.5	78	1.5	8	2	
	3	●	MMS0800S-DIN-C	29.5	41.5	42.5	79.5	78	1.5	8	1	
	5	□	MMS0800L-DIN	41.5	53.5	54.5	91.5	90	1.5	8	2	
	5	●	MMS0800L-DIN-C	41.5	53.5	54.5	91.5	90	1.5	8	1	
	3	★	MMS0800X3DB	25.5	41.5	41.5	91.5	90	1.5	8	1	
	5	★	MMS0800X5DB	41.5	57.5	57.5	104.5	103	1.5	8	1	
8.05	3	□	MMS0805S-DIN	34.4	46.5	47.5	88.5	87	1.5	10	2	
	3	●	MMS0805S-DIN-C	34.4	46.5	47.5	88.5	87	1.5	10	1	
	5	□	MMS0805L-DIN	48.4	60.5	61.5	102.5	101	1.5	10	2	
	5	●	MMS0805L-DIN-C	48.4	60.5	61.5	102.5	101	1.5	10	1	
	8.1	3	□	MMS0810S-DIN	34.3	46.5	47.5	88.5	87	1.5	10	2
		3	□	MMS0810S-DIN-C	34.3	46.5	47.5	88.5	87	1.5	10	1
5		□	MMS0810L-DIN	48.3	60.5	61.5	102.5	101	1.5	10	2	
5		□	MMS0810L-DIN-C	48.3	60.5	61.5	102.5	101	1.5	10	1	
3		★	MMS0810X3DB	25.8	44.5	46.5	97.5	96	1.5	10	1	
5		★	MMS0810X5DB	42.0	61.5	63.5	114.5	113	1.5	10	1	
8.2	3	□	MMS0820S-DIN	34.2	46.5	47.5	88.5	87	1.5	10	2	
	3	□	MMS0820S-DIN-C	34.2	46.5	47.5	88.5	87	1.5	10	1	
	5	□	MMS0820L-DIN	48.2	60.5	61.5	102.5	101	1.5	10	2	
	5	□	MMS0820L-DIN-C	48.2	60.5	61.5	102.5	101	1.5	10	1	
	3	★	MMS0820X3DB	26.1	44.5	46.5	97.5	96	1.5	10	1	
	5	★	MMS0820X5DB	42.5	61.5	63.5	114.5	113	1.5	10	1	
8.3	3	□	MMS0830S-DIN	34.1	46.5	47.5	88.5	87	1.5	10	2	
	3	●	MMS0830S-DIN-C	34.1	46.5	47.5	88.5	87	1.5	10	1	
	5	□	MMS0830L-DIN	48.1	60.5	61.5	102.5	101	1.5	10	2	
	5	●	MMS0830L-DIN-C	48.1	60.5	61.5	102.5	101	1.5	10	1	
	3	★	MMS0830X3DB	26.4	44.5	46.5	97.5	96	1.5	10	1	
	5	★	MMS0830X5DB	43.0	61.5	63.5	114.5	113	1.5	10	1	
8.4	3	□	MMS0840S-DIN	33.9	46.5	47.5	88.5	87	1.5	10	2	
	3	□	MMS0840S-DIN-C	33.9	46.5	47.5	88.5	87	1.5	10	1	
	5	□	MMS0840L-DIN	47.9	60.5	61.5	102.5	101	1.5	10	2	
	5	□	MMS0840L-DIN-C	47.9	60.5	61.5	102.5	101	1.5	10	1	
	3	★	MMS0840X3DB	26.7	44.5	46.5	97.5	96	1.5	10	1	
	5	★	MMS0840X5DB	43.5	61.5	63.5	114.5	113	1.5	10	1	
8.5	3	□	MMS0850S-DIN	33.8	46.5	47.5	88.5	87	1.5	10	2	
	3	●	MMS0850S-DIN-C	33.8	46.5	47.5	88.5	87	1.5	10	1	
	5	□	MMS0850L-DIN	47.8	60.5	61.5	102.5	101	1.5	10	2	
	5	●	MMS0850L-DIN-C	47.8	60.5	61.5	102.5	101	1.5	10	1	
	3	★	MMS0850X3DB	27.0	44.5	46.5	97.5	96	1.5	10	1	
	5	★	MMS0850X5DB	44.0	61.5	63.5	114.5	113	1.5	10	1	

М
ИНСТРУМЕНТ ДЛЯ
СВЕРЛЕНИЯ

ИНСТРУМЕНТ ДЛЯ СВЕРЛЕНИЯ (МОНОЛИТНЫЕ ТВЕРДОСПЛАВНЫЕ СВЕРЛА)

MMS

ТВЕРДЫЙ
СПЛАВ

ИНСТРУМЕНТ ДЛЯ
СВЕРЛЕНИЯ

M

DC (мм)	Глубина сверления (L/D)	DP7020	Обозначение	Размеры (мм)							Тип
				LU	LCF	LH	OAL	LF	PL	DCON	
8.6	3	□	MMS0860S-DIN	33.7	46.6	47.6	88.6	87	1.6	10	2
	3	●	MMS0860S-DIN-C	33.7	46.6	47.6	88.6	87	1.6	10	1
	5	□	MMS0860L-DIN	47.7	60.6	61.6	102.6	101	1.6	10	2
	5	●	MMS0860L-DIN-C	47.7	60.6	61.6	102.6	101	1.6	10	1
	3	★	MMS0860X3DB	27.4	46.6	48.6	102.6	101	1.6	10	1
	5	★	MMS0860X5DB	44.6	64.6	66.6	117.6	116	1.6	10	1
8.7	3	□	MMS0870S-DIN	33.5	46.6	47.6	88.6	87	1.6	10	2
	3	●	MMS0870S-DIN-C	33.5	46.6	47.6	88.6	87	1.6	10	1
	5	□	MMS0870L-DIN	47.5	60.6	61.6	102.6	101	1.6	10	2
	5	●	MMS0870L-DIN-C	47.5	60.6	61.6	102.6	101	1.6	10	1
	3	★	MMS0870X3DB	27.7	46.6	48.6	102.6	101	1.6	10	1
	5	★	MMS0870X5DB	45.1	64.6	66.6	117.6	116	1.6	10	1
8.8	3	□	MMS0880S-DIN	33.4	46.6	47.6	88.6	87	1.6	10	2
	3	●	MMS0880S-DIN-C	33.4	46.6	47.6	88.6	87	1.6	10	1
	5	□	MMS0880L-DIN	47.4	60.6	61.6	102.6	101	1.6	10	2
	5	●	MMS0880L-DIN-C	47.4	60.6	61.6	102.6	101	1.6	10	1
	3	★	MMS0880X3DB	28.0	46.6	48.6	102.6	101	1.6	10	1
	5	★	MMS0880X5DB	45.6	64.6	66.6	117.6	116	1.6	10	1
8.9	3	□	MMS0890S-DIN	33.3	46.6	47.6	88.6	87	1.6	10	2
	3	●	MMS0890S-DIN-C	33.3	46.6	47.6	88.6	87	1.6	10	1
	5	□	MMS0890L-DIN	47.3	60.6	61.6	102.6	101	1.6	10	2
	5	●	MMS0890L-DIN-C	47.3	60.6	61.6	102.6	101	1.6	10	1
	3	★	MMS0890X3DB	28.3	46.6	48.6	102.6	101	1.6	10	1
	5	★	MMS0890X5DB	46.1	64.6	66.6	117.6	116	1.6	10	1
9.0	3	□	MMS0900S-DIN	33.1	46.6	47.6	88.6	87	1.6	10	2
	3	●	MMS0900S-DIN-C	33.1	46.6	47.6	88.6	87	1.6	10	1
	5	□	MMS0900L-DIN	47.1	60.6	61.6	102.6	101	1.6	10	2
	5	●	MMS0900L-DIN-C	47.1	60.6	61.6	102.6	101	1.6	10	1
	3	★	MMS0900X3DB	28.6	46.6	48.6	102.6	101	1.6	10	1
	5	★	MMS0900X5DB	46.6	64.6	66.6	117.6	116	1.6	10	1
9.1	3	□	MMS0910S-DIN	33.0	46.7	47.7	88.7	87	1.7	10	2
	3	●	MMS0910S-DIN-C	33.0	46.7	47.7	88.7	87	1.7	10	1
	5	□	MMS0910L-DIN	47.0	60.7	61.7	102.7	101	1.7	10	2
	5	●	MMS0910L-DIN-C	47.0	60.7	61.7	102.7	101	1.7	10	1
	3	★	MMS0910X3DB	29.0	49.7	51.7	102.7	101	1.7	10	1
	5	★	MMS0910X5DB	47.2	68.7	71.7	122.7	121	1.7	10	1
9.2	3	□	MMS0920S-DIN	32.9	46.7	47.7	88.7	87	1.7	10	2
	3	●	MMS0920S-DIN-C	32.9	46.7	47.7	88.7	87	1.7	10	1
	5	□	MMS0920L-DIN	46.9	60.7	61.7	102.7	101	1.7	10	2
	5	●	MMS0920L-DIN-C	46.9	60.7	61.7	102.7	101	1.7	10	1
	3	★	MMS0920X3DB	29.3	49.7	51.7	102.7	101	1.7	10	1
	5	★	MMS0920X5DB	47.7	68.7	71.7	122.7	121	1.7	10	1
9.3	3	□	MMS0930S-DIN	32.7	46.7	47.7	88.7	87	1.7	10	2
	3	●	MMS0930S-DIN-C	32.7	46.7	47.7	88.7	87	1.7	10	1
	5	□	MMS0930L-DIN	46.7	60.7	61.7	102.7	101	1.7	10	2
	5	●	MMS0930L-DIN-C	46.7	60.7	61.7	102.7	101	1.7	10	1
	3	★	MMS0930X3DB	29.6	49.7	51.7	102.7	101	1.7	10	1
	5	★	MMS0930X5DB	48.2	68.7	71.7	122.7	121	1.7	10	1

DC (мм)	Глубина сверления (L/D)	DP7020	Обозначение	Размеры (мм)							Тип
				LU	LCF	LH	OAL	LF	PL	DCON	
9.4	3	□	MMS0940S-DIN	32.6	46.7	47.7	88.7	87	1.7	10	2
	3	●	MMS0940S-DIN-C	32.6	46.7	47.7	88.7	87	1.7	10	1
	5	□	MMS0940L-DIN	46.6	60.7	61.7	102.7	101	1.7	10	2
	5	●	MMS0940L-DIN-C	46.6	60.7	61.7	102.7	101	1.7	10	1
	3	★	MMS0940X3DB	29.9	49.7	51.7	102.7	101	1.7	10	1
	5	★	MMS0940X5DB	48.7	68.7	71.7	122.7	121	1.7	10	1
9.5	3	□	MMS0950S-DIN	32.5	46.7	47.7	88.7	87	1.7	10	2
	3	●	MMS0950S-DIN-C	32.5	46.7	47.7	88.7	87	1.7	10	1
	5	□	MMS0950L-DIN	46.5	60.7	61.7	102.7	101	1.7	10	2
	5	●	MMS0950L-DIN-C	46.5	60.7	61.7	102.7	101	1.7	10	1
	3	★	MMS0950X3DB	30.2	49.7	51.7	102.7	101	1.7	10	1
	5	★	MMS0950X5DB	49.2	68.7	71.7	122.7	121	1.7	10	1
9.6	3	□	MMS0960S-DIN	32.3	46.7	47.7	88.7	87	1.7	10	2
	3	●	MMS0960S-DIN-C	32.3	46.7	47.7	88.7	87	1.7	10	1
	5	□	MMS0960L-DIN	46.3	60.7	61.7	102.7	101	1.7	10	2
	5	●	MMS0960L-DIN-C	46.3	60.7	61.7	102.7	101	1.7	10	1
	3	★	MMS0960X3DB	30.5	51.7	51.7	102.7	101	1.7	10	1
	5	★	MMS0960X5DB	49.7	71.7	71.7	122.7	121	1.7	10	1
9.7	3	□	MMS0970S-DIN	32.2	46.8	47.8	88.8	87	1.8	10	2
	3	●	MMS0970S-DIN-C	32.2	46.8	47.8	88.8	87	1.8	10	1
	5	□	MMS0970L-DIN	46.2	60.8	61.8	102.8	101	1.8	10	2
	5	●	MMS0970L-DIN-C	46.2	60.8	61.8	102.8	101	1.8	10	1
	3	★	MMS0970X3DB	30.9	51.8	51.8	102.8	101	1.8	10	1
	5	★	MMS0970X5DB	50.3	71.8	71.8	122.8	121	1.8	10	1
9.8	3	□	MMS0980S-DIN	32.1	46.8	47.8	88.8	87	1.8	10	2
	3	●	MMS0980S-DIN-C	32.1	46.8	47.8	88.8	87	1.8	10	1
	5	□	MMS0980L-DIN	46.1	60.8	61.8	102.8	101	1.8	10	2
	5	●	MMS0980L-DIN-C	46.1	60.8	61.8	102.8	101	1.8	10	1
	3	★	MMS0980X3DB	31.2	51.8	51.8	102.8	101	1.8	10	1
	5	★	MMS0980X5DB	50.8	71.8	71.8	122.8	121	1.8	10	1
9.9	3	□	MMS0990S-DIN	32.0	46.8	47.8	88.8	87	1.8	10	2
	3	●	MMS0990S-DIN-C	32.0	46.8	47.8	88.8	87	1.8	10	1
	5	□	MMS0990L-DIN	46.0	60.8	61.8	102.8	101	1.8	10	2
	5	●	MMS0990L-DIN-C	46.0	60.8	61.8	102.8	101	1.8	10	1
	3	★	MMS0990X3DB	31.5	51.8	51.8	102.8	101	1.8	10	1
	5	★	MMS0990X5DB	51.3	71.8	71.8	122.8	121	1.8	10	1
10.0	3	□	MMS1000S-DIN	31.8	46.8	47.8	88.8	87	1.8	10	2
	3	●	MMS1000S-DIN-C	31.8	46.8	47.8	88.8	87	1.8	10	1
	5	□	MMS1000L-DIN	45.8	60.8	61.8	102.8	101	1.8	10	2
	5	●	MMS1000L-DIN-C	45.8	60.8	61.8	102.8	101	1.8	10	1
	3	★	MMS1000X3DB	31.8	51.8	51.8	102.8	101	1.8	10	1
	5	★	MMS1000X5DB	51.8	71.8	71.8	122.8	121	1.8	10	1
10.05	3	□	MMS1005S-DIN	39.8	54.8	55.8	101.8	100	1.8	12	2
	3	●	MMS1005S-DIN-C	39.8	54.8	55.8	101.8	100	1.8	12	1
	5	□	MMS1005L-DIN	55.8	70.8	71.8	117.8	116	1.8	12	2
	5	●	MMS1005L-DIN-C	55.8	70.8	71.8	117.8	116	1.8	12	1

● : Есть на складе. ★ : Со склада в Японии.

□ : Нет на складе, выпускается исключительно под заказ.

DC	Глубина сверления (L/D)	DP7020	Обозначение	Размеры (мм)							Тип
				LU	LCF	LH	OAL	LF	PL	DCON	
10.1	3	□	MMS1010S-DIN	39.7	54.8	55.8	101.8	100	1.8	12	2
	3	□	MMS1010S-DIN-C	39.7	54.8	55.8	101.8	100	1.8	12	1
	5	□	MMS1010L-DIN	55.7	70.8	71.8	117.8	116	1.8	12	2
	5	□	MMS1010L-DIN-C	55.7	70.8	71.8	117.8	116	1.8	12	1
	3	★	MMS1010X3DB	32.1	54.8	56.8	112.8	111	1.8	12	1
	5	★	MMS1010X5DB	52.3	75.8	79.8	135.8	134	1.8	12	1
10.2	3	□	MMS1020S-DIN	39.6	54.9	55.9	101.9	100	1.9	12	2
	3	●	MMS1020S-DIN-C	39.6	54.9	55.9	101.9	100	1.9	12	1
	5	□	MMS1020L-DIN	55.6	70.9	71.9	117.9	116	1.9	12	2
	5	●	MMS1020L-DIN-C	55.6	70.9	71.9	117.9	116	1.9	12	1
	3	★	MMS1020X3DB	32.5	54.9	56.9	112.9	111	1.9	12	1
	5	★	MMS1020X5DB	52.9	75.9	79.9	135.9	134	1.9	12	1
10.3	3	□	MMS1030S-DIN	39.4	54.9	55.9	101.9	100	1.9	12	2
	3	●	MMS1030S-DIN-C	39.4	54.9	55.9	101.9	100	1.9	12	1
	5	□	MMS1030L-DIN	55.4	70.9	71.9	117.9	116	1.9	12	2
	5	●	MMS1030L-DIN-C	55.4	70.9	71.9	117.9	116	1.9	12	1
	3	★	MMS1030X3DB	32.8	54.9	56.9	112.9	111	1.9	12	1
	5	★	MMS1030X5DB	53.4	75.9	79.9	135.9	134	1.9	12	1
10.4	3	□	MMS1040S-DIN	39.3	54.9	55.9	101.9	100	1.9	12	2
	3	●	MMS1040S-DIN-C	39.3	54.9	55.9	101.9	100	1.9	12	1
	5	□	MMS1040L-DIN	55.3	70.9	71.9	117.9	116	1.9	12	2
	5	●	MMS1040L-DIN-C	55.3	70.9	71.9	117.9	116	1.9	12	1
	3	★	MMS1040X3DB	33.1	54.9	56.9	112.9	111	1.9	12	1
	5	★	MMS1040X5DB	53.9	75.9	79.9	135.9	134	1.9	12	1
10.5	3	□	MMS1050S-DIN	39.2	54.9	55.9	101.9	100	1.9	12	2
	3	●	MMS1050S-DIN-C	39.2	54.9	55.9	101.9	100	1.9	12	1
	5	□	MMS1050L-DIN	55.2	70.9	71.9	117.9	116	1.9	12	2
	5	●	MMS1050L-DIN-C	55.2	70.9	71.9	117.9	116	1.9	12	1
	3	★	MMS1050X3DB	33.4	54.9	56.9	112.9	111	1.9	12	1
	5	★	MMS1050X5DB	54.4	75.9	79.9	135.9	134	1.9	12	1
10.6	3	□	MMS1060S-DIN	39.0	54.9	55.9	101.9	100	1.9	12	2
	3	□	MMS1060S-DIN-C	39.0	54.9	55.9	101.9	100	1.9	12	1
	5	□	MMS1060L-DIN	55.0	70.9	71.9	117.9	116	1.9	12	2
	5	□	MMS1060L-DIN-C	55.0	70.9	71.9	117.9	116	1.9	12	1
	3	★	MMS1060X3DB	33.7	56.9	57.9	117.9	116	1.9	12	1
	5	★	MMS1060X5DB	54.9	78.9	79.9	135.9	134	1.9	12	1
10.7	3	□	MMS1070S-DIN	38.9	54.9	55.9	101.9	100	1.9	12	2
	3	●	MMS1070S-DIN-C	38.9	54.9	55.9	101.9	100	1.9	12	1
	5	□	MMS1070L-DIN	54.9	70.9	71.9	117.9	116	1.9	12	2
	5	●	MMS1070L-DIN-C	54.9	70.9	71.9	117.9	116	1.9	12	1
	3	★	MMS1070X3DB	34.0	56.9	57.9	117.9	116	1.9	12	1
	5	★	MMS1070X5DB	55.4	78.9	79.9	135.9	134	1.9	12	1
10.8	3	□	MMS1080S-DIN	38.8	55.0	56.0	102.0	100	2.0	12	2
	3	●	MMS1080S-DIN-C	38.8	55.0	56.0	102.0	100	2.0	12	1
	5	□	MMS1080L-DIN	54.8	71.0	72.0	118.0	116	2.0	12	2
	5	●	MMS1080L-DIN-C	54.8	71.0	72.0	118.0	116	2.0	12	1
	3	★	MMS1080X3DB	34.4	57.0	58.0	118.0	116	2.0	12	1
	5	★	MMS1080X5DB	56.0	79.0	80.0	136.0	134	2.0	12	1

DC	Глубина сверления (L/D)	DP7020	Обозначение	Размеры (мм)							Тип
				LU	LCF	LH	OAL	LF	PL	DCON	
10.9	3	□	MMS1090S-DIN	38.6	55.0	56.0	102.0	100	2.0	12	2
	3	□	MMS1090S-DIN-C	38.6	55.0	56.0	102.0	100	2.0	12	1
	5	□	MMS1090L-DIN	54.6	71.0	72.0	118.0	116	2.0	12	2
	5	□	MMS1090L-DIN-C	54.6	71.0	72.0	118.0	116	2.0	12	1
	3	★	MMS1090X3DB	34.7	57.0	58.0	118.0	116	2.0	12	1
	5	★	MMS1090X5DB	56.5	79.0	80.0	136.0	134	2.0	12	1
11.0	3	□	MMS1100S-DIN	38.5	55.0	56.0	102.0	100	2.0	12	2
	3	●	MMS1100S-DIN-C	38.5	55.0	56.0	102.0	100	2.0	12	1
	5	□	MMS1100L-DIN	54.5	71.0	72.0	118.0	116	2.0	12	2
	5	●	MMS1100L-DIN-C	54.5	71.0	72.0	118.0	116	2.0	12	1
	3	★	MMS1100X3DB	35.0	57.0	58.0	118.0	116	2.0	12	1
	5	★	MMS1100X5DB	57.0	79.0	80.0	136.0	134	2.0	12	1
11.1	3	□	MMS1110S-DIN	38.4	55.0	56.0	102.0	100	2.0	12	2
	3	□	MMS1110S-DIN-C	38.4	55.0	56.0	102.0	100	2.0	12	1
	5	□	MMS1110L-DIN	54.4	71.0	72.0	118.0	116	2.0	12	2
	5	□	MMS1110L-DIN-C	54.4	71.0	72.0	118.0	116	2.0	12	1
	3	★	MMS1110X3DB	35.3	60.0	62.0	118.0	116	2.0	12	1
	5	★	MMS1110X5DB	57.5	83.0	86.0	142.0	140	2.0	12	1
11.2	3	□	MMS1120S-DIN	38.2	55.0	56.0	102.0	100	2.0	12	2
	3	●	MMS1120S-DIN-C	38.2	55.0	56.0	102.0	100	2.0	12	1
	5	□	MMS1120L-DIN	54.2	71.0	72.0	118.0	116	2.0	12	2
	5	●	MMS1120L-DIN-C	54.2	71.0	72.0	118.0	116	2.0	12	1
	3	★	MMS1120X3DB	35.6	60.0	62.0	118.0	116	2.0	12	1
	5	★	MMS1120X5DB	58.0	83.0	86.0	142.0	140	2.0	12	1
11.3	3	□	MMS1130S-DIN	38.1	55.1	56.1	102.1	100	2.1	12	2
	3	□	MMS1130S-DIN-C	38.1	55.1	56.1	102.1	100	2.1	12	1
	5	□	MMS1130L-DIN	54.1	71.1	72.1	118.1	116	2.1	12	2
	5	□	MMS1130L-DIN-C	54.1	71.1	72.1	118.1	116	2.1	12	1
	3	★	MMS1130X3DB	36.0	60.1	62.1	118.1	116	2.1	12	1
	5	★	MMS1130X5DB	58.6	83.1	86.1	142.1	140	2.1	12	1
11.4	3	□	MMS1140S-DIN	38.0	55.1	56.1	102.1	100	2.1	12	2
	3	●	MMS1140S-DIN-C	38.0	55.1	56.1	102.1	100	2.1	12	1
	5	□	MMS1140L-DIN	54.0	71.1	72.1	118.1	116	2.1	12	2
	5	●	MMS1140L-DIN-C	54.0	71.1	72.1	118.1	116	2.1	12	1
	3	★	MMS1140X3DB	36.3	60.1	62.1	118.1	116	2.1	12	1
	5	★	MMS1140X5DB	59.1	83.1	86.1	142.1	140	2.1	12	1
11.5	3	□	MMS1150S-DIN	37.8	55.1	56.1	102.1	100	2.1	12	2
	3	●	MMS1150S-DIN-C	37.8	55.1	56.1	102.1	100	2.1	12	1
	5	□	MMS1150L-DIN	53.8	71.1	72.1	118.1	116	2.1	12	2
	5	●	MMS1150L-DIN-C	53.8	71.1	72.1	118.1	116	2.1	12	1
	3	★	MMS1150X3DB	36.6	60.1	62.1	118.1	116	2.1	12	1
	5	★	MMS1150X5DB	59.6	83.1	86.1	142.1	140	2.1	12	1
11.6	3	□	MMS1160S-DIN	37.7	55.1	56.1	102.1	100	2.1	12	2
	3	□	MMS1160S-DIN-C	37.7	55.1	56.1	102.1	100	2.1	12	1
	5	□	MMS1160L-DIN	53.7	71.1	72.1	118.1	116	2.1	12	2
	5	□	MMS1160L-DIN-C	53.7	71.1	72.1	118.1	116	2.1	12	1
	3	★	MMS1160X3DB	36.9	62.1	62.1	118.1	116	2.1	12	1
	5	★	MMS1160X5DB	60.1	86.1	86.1	142.1	140	2.1	12	1

ИНСТРУМЕНТ ДЛЯ СВЕРЛЕНИЯ (МОНОЛИТНЫЕ ТВЕРДОСПЛАВНЫЕ СВЕРЛА)

MMS

ТВЕРДЫЙ СПЛАВ

ИНСТРУМЕНТ ДЛЯ СВЕРЛЕНИЯ

M

DC (мм)	Глубина сверления (L/D)	DP7020	Обозначение	Размеры (мм)								Тип
				LU	LCF	LH	OAL	LF	PL	DCON		
11.7	3	□	MMS1170S-DIN	37.6	55.1	56.1	102.1	100	2.1	12	2	
	3	●	MMS1170S-DIN-C	37.6	55.1	56.1	102.1	100	2.1	12	1	
	5	□	MMS1170L-DIN	53.6	71.1	72.1	118.1	116	2.1	12	2	
	5	●	MMS1170L-DIN-C	53.6	71.1	72.1	118.1	116	2.1	12	1	
	3	★	MMS1170X3DB	37.2	62.1	62.1	118.1	116	2.1	12	1	
	5	★	MMS1170X5DB	60.6	86.1	86.1	142.1	140	2.1	12	1	
11.8	3	□	MMS1180S-DIN	37.4	55.1	56.1	102.1	100	2.1	12	2	
	3	●	MMS1180S-DIN-C	37.4	55.1	56.1	102.1	100	2.1	12	1	
	5	□	MMS1180L-DIN	53.4	71.1	72.1	118.1	116	2.1	12	2	
	5	●	MMS1180L-DIN-C	53.4	71.1	72.1	118.1	116	2.1	12	1	
	3	★	MMS1180X3DB	37.5	62.1	62.1	118.1	116	2.1	12	1	
	5	★	MMS1180X5DB	61.1	86.1	86.1	142.1	140	2.1	12	1	
11.9	3	□	MMS1190S-DIN	37.3	55.2	56.2	102.2	100	2.2	12	2	
	3	□	MMS1190S-DIN-C	37.3	55.2	56.2	102.2	100	2.2	12	1	
	5	□	MMS1190L-DIN	53.3	71.2	72.2	118.2	116	2.2	12	2	
	5	□	MMS1190L-DIN-C	53.3	71.2	72.2	118.2	116	2.2	12	1	
	3	★	MMS1190X3DB	37.9	62.2	62.2	118.2	116	2.2	12	1	
	5	★	MMS1190X5DB	61.7	86.2	86.2	142.2	140	2.2	12	1	
12.0	3	□	MMS1200S-DIN	37.2	55.2	56.2	102.2	100	2.2	12	2	
	3	●	MMS1200S-DIN-C	37.2	55.2	56.2	102.2	100	2.2	12	1	
	5	□	MMS1200L-DIN	53.2	71.2	72.2	118.2	116	2.2	12	2	
	5	●	MMS1200L-DIN-C	53.2	71.2	72.2	118.2	116	2.2	12	1	
	3	★	MMS1200X3DB	38.2	62.2	62.2	118.2	116	2.2	12	1	
	5	★	MMS1200X5DB	62.2	86.2	86.2	142.2	140	2.2	12	1	
12.05	3	□	MMS1205S-DIN	42.1	60.2	61.2	107.2	105	2.2	14	2	
	3	●	MMS1205S-DIN-C	42.1	60.2	61.2	107.2	105	2.2	14	1	
	5	□	MMS1205L-DIN	59.1	77.2	78.2	124.2	122	2.2	14	2	
	5	●	MMS1205L-DIN-C	59.1	77.2	78.2	124.2	122	2.2	14	1	
12.1	3	□	MMS1210S-DIN	42.1	60.2	61.2	107.2	105	2.2	14	2	
	3	□	MMS1210S-DIN-C	42.1	60.2	61.2	107.2	105	2.2	14	1	
	5	□	MMS1210L-DIN	59.1	77.2	78.2	124.2	122	2.2	14	2	
	5	□	MMS1210L-DIN-C	59.1	77.2	78.2	124.2	122	2.2	14	1	
	3	★	MMS1210X3DB	38.5	65.2	68.2	124.2	122	2.2	14	1	
12.2	3	□	MMS1220S-DIN	41.9	60.2	61.2	107.2	105	2.2	14	2	
	3	□	MMS1220S-DIN-C	41.9	60.2	61.2	107.2	105	2.2	14	1	
	5	□	MMS1220L-DIN	58.9	77.2	78.2	124.2	122	2.2	14	2	
	5	□	MMS1220L-DIN-C	58.9	77.2	78.2	124.2	122	2.2	14	1	
	3	★	MMS1220X3DB	38.8	65.2	68.2	124.2	122	2.2	14	1	
	5	★	MMS1220X5DB	63.2	90.2	94.2	150.2	148	2.2	14	1	
12.3	3	□	MMS1230S-DIN	41.8	60.2	61.2	107.2	105	2.2	14	2	
	3	□	MMS1230S-DIN-C	41.8	60.2	61.2	107.2	105	2.2	14	1	
	5	□	MMS1230L-DIN	58.8	77.2	78.2	124.2	122	2.2	14	2	
	5	□	MMS1230L-DIN-C	58.8	77.2	78.2	124.2	122	2.2	14	1	
	3	★	MMS1230X3DB	39.1	65.2	68.2	124.2	122	2.2	14	1	
5	★	MMS1230X5DB	63.7	90.2	94.2	150.2	148	2.2	14	1		

DC (мм)	Глубина сверления (L/D)	DP7020	Обозначение	Размеры (мм)								Тип
				LU	LCF	LH	OAL	LF	PL	DCON		
12.4	3	□	MMS1240S-DIN	41.7	60.3	61.3	107.3	105	2.3	14	2	
	3	□	MMS1240S-DIN-C	41.7	60.3	61.3	107.3	105	2.3	14	1	
	5	□	MMS1240L-DIN	58.7	77.3	78.3	124.3	122	2.3	14	2	
	5	□	MMS1240L-DIN-C	58.7	77.3	78.3	124.3	122	2.3	14	1	
	3	★	MMS1240X3DB	39.5	65.3	68.3	124.3	122	2.3	14	1	
	5	★	MMS1240X5DB	64.3	90.3	94.3	150.3	148	2.3	14	1	
12.5	3	□	MMS1250S-DIN	41.5	60.3	61.3	107.3	105	2.3	14	2	
	3	●	MMS1250S-DIN-C	41.5	60.3	61.3	107.3	105	2.3	14	1	
	5	□	MMS1250L-DIN	58.5	77.3	78.3	124.3	122	2.3	14	2	
	5	●	MMS1250L-DIN-C	58.5	77.3	78.3	124.3	122	2.3	14	1	
	3	★	MMS1250X3DB	39.8	65.3	68.3	124.3	122	2.3	14	1	
	5	★	MMS1250X5DB	64.8	90.3	94.3	150.3	148	2.3	14	1	
12.6	3	□	MMS1260S-DIN	41.4	60.3	61.3	107.3	105	2.3	14	2	
	3	●	MMS1260S-DIN-C	41.4	60.3	61.3	107.3	105	2.3	14	1	
	5	□	MMS1260L-DIN	58.4	77.3	78.3	124.3	122	2.3	14	2	
	5	●	MMS1260L-DIN-C	58.4	77.3	78.3	124.3	122	2.3	14	1	
	3	★	MMS1260X3DB	40.1	67.3	68.3	124.3	122	2.3	14	1	
	5	★	MMS1260X5DB	65.3	93.3	94.3	150.3	148	2.3	14	1	
12.7	3	□	MMS1270S-DIN	41.3	60.3	61.3	107.3	105	2.3	14	2	
	3	●	MMS1270S-DIN-C	41.3	60.3	61.3	107.3	105	2.3	14	1	
	5	□	MMS1270L-DIN	58.3	77.3	78.3	124.3	122	2.3	14	2	
	5	●	MMS1270L-DIN-C	58.3	77.3	78.3	124.3	122	2.3	14	1	
	3	★	MMS1270X3DB	40.4	67.3	68.3	124.3	122	2.3	14	1	
	5	★	MMS1270X5DB	65.8	93.3	94.3	150.3	148	2.3	14	1	
12.8	3	□	MMS1280S-DIN	41.1	60.3	61.3	107.3	105	2.3	14	2	
	3	□	MMS1280S-DIN-C	41.1	60.3	61.3	107.3	105	2.3	14	1	
	5	□	MMS1280L-DIN	58.1	77.3	78.3	124.3	122	2.3	14	2	
	5	□	MMS1280L-DIN-C	58.1	77.3	78.3	124.3	122	2.3	14	1	
	3	★	MMS1280X3DB	40.7	67.3	68.3	124.3	122	2.3	14	1	
	5	★	MMS1280X5DB	66.3	93.3	94.3	150.3	148	2.3	14	1	
12.9	3	□	MMS1290S-DIN	41.0	60.3	61.3	107.3	105	2.3	14	2	
	3	□	MMS1290S-DIN-C	41.0	60.3	61.3	107.3	105	2.3	14	1	
	5	□	MMS1290L-DIN	58.0	77.3	78.3	124.3	122	2.3	14	2	
	5	□	MMS1290L-DIN-C	58.0	77.3	78.3	124.3	122	2.3	14	1	
	3	★	MMS1290X3DB	41.0	67.3	68.3	124.3	122	2.3	14	1	
	5	★	MMS1290X5DB	66.8	93.3	94.3	150.3	148	2.3	14	1	
13.0	3	□	MMS1300S-DIN	40.9	60.4	61.4	107.4	105	2.4	14	2	
	3	●	MMS1300S-DIN-C	40.9	60.4	61.4	107.4	105	2.4	14	1	
	5	□	MMS1300L-DIN	57.9	77.4	78.4	124.4	122	2.4	14	2	
	5	●	MMS1300L-DIN-C	57.9	77.4	78.4	124.4	122	2.4	14	1	
	3	★	MMS1300X3DB	41.4	67.4	68.4	124.4	122	2.4	14	1	
	5	★	MMS1300X5DB	67.4	93.4	94.4	150.4	148	2.4	14	1	
13.1	3	□	MMS1310S-DIN	40.7	60.4	61.4	107.4	105	2.4	14	2	
	3	□	MMS1310S-DIN-C	40.7	60.4	61.4	107.4	105	2.4	14	1	
	5	□	MMS1310L-DIN	57.7	77.4	78.4	124.4	122	2.4	14	2	
	5	□	MMS1310L-DIN-C	57.7	77.4	78.4	124.4	122	2.4	14	1	
	3	★	MMS1310X3DB	41.7	70.4	72.4	128.4	126	2.4	14	1	
	5	★	MMS1310X5DB	67.9	97.4	100.4	156.4	154	2.4	14	1	

● : Есть на складе. ★ : Со склада в Японии.

□ : Нет на складе, выпускается исключительно под заказ.

DC	Глубина сверления (L/D)	DP7020	Обозначение	Размеры (мм)							Тип
				LU	LCF	LH	OAL	LF	PL	DCON	
13.2	3	□	MMS1320S-DIN	40.6	60.4	61.4	107.4	105	2.4	14	2
	3	□	MMS1320S-DIN-C	40.6	60.4	61.4	107.4	105	2.4	14	1
	5	□	MMS1320L-DIN	57.6	77.4	78.4	124.4	122	2.4	14	2
	5	□	MMS1320L-DIN-C	57.6	77.4	78.4	124.4	122	2.4	14	1
	3	★	MMS1320X3DB	42.0	70.4	72.4	128.4	126	2.4	14	1
	5	★	MMS1320X5DB	68.4	97.4	100.4	156.4	154	2.4	14	1
13.3	3	□	MMS1330S-DIN	40.5	60.4	61.4	107.4	105	2.4	14	2
	3	□	MMS1330S-DIN-C	40.5	60.4	61.4	107.4	105	2.4	14	1
	5	□	MMS1330L-DIN	57.5	77.4	78.4	124.4	122	2.4	14	2
	5	□	MMS1330L-DIN-C	57.5	77.4	78.4	124.4	122	2.4	14	1
	3	★	MMS1330X3DB	42.3	70.4	72.4	128.4	126	2.4	14	1
	5	★	MMS1330X5DB	68.9	97.4	100.4	156.4	154	2.4	14	1
13.4	3	□	MMS1340S-DIN	40.3	60.4	61.4	107.4	105	2.4	14	2
	3	□	MMS1340S-DIN-C	40.3	60.4	61.4	107.4	105	2.4	14	1
	5	□	MMS1340L-DIN	57.3	77.4	78.4	124.4	122	2.4	14	2
	5	□	MMS1340L-DIN-C	57.3	77.4	78.4	124.4	122	2.4	14	1
	3	★	MMS1340X3DB	42.6	70.4	72.4	128.4	126	2.4	14	1
	5	★	MMS1340X5DB	69.4	97.4	100.4	156.4	154	2.4	14	1
13.5	3	□	MMS1350S-DIN	40.2	60.5	61.5	107.5	105	2.5	14	2
	3	●	MMS1350S-DIN-C	40.2	60.5	61.5	107.5	105	2.5	14	1
	5	□	MMS1350L-DIN	57.2	77.5	78.5	124.5	122	2.5	14	2
	5	●	MMS1350L-DIN-C	57.2	77.5	78.5	124.5	122	2.5	14	1
	3	★	MMS1350X3DB	43.0	70.5	72.5	128.5	126	2.5	14	1
	5	★	MMS1350X5DB	70.0	97.5	100.5	156.5	154	2.5	14	1
13.6	3	□	MMS1360S-DIN	40.1	60.5	61.5	107.5	105	2.5	14	2
	3	□	MMS1360S-DIN-C	40.1	60.5	61.5	107.5	105	2.5	14	1
	5	□	MMS1360L-DIN	57.1	77.5	78.5	124.5	122	2.5	14	2
	5	□	MMS1360L-DIN-C	57.1	77.5	78.5	124.5	122	2.5	14	1
	3	★	MMS1360X3DB	43.3	72.5	72.5	128.5	126	2.5	14	1
	5	★	MMS1360X5DB	70.5	100.5	100.5	156.5	154	2.5	14	1
13.7	3	□	MMS1370S-DIN	39.9	60.5	61.5	107.5	105	2.5	14	2
	3	●	MMS1370S-DIN-C	39.9	60.5	61.5	107.5	105	2.5	14	1
	5	□	MMS1370L-DIN	56.9	77.5	78.5	124.5	122	2.5	14	2
	5	●	MMS1370L-DIN-C	56.9	77.5	78.5	124.5	122	2.5	14	1
	3	★	MMS1370X3DB	43.6	72.5	72.5	128.5	126	2.5	14	1
	5	★	MMS1370X5DB	71.0	100.5	100.5	156.5	154	2.5	14	1
13.8	3	□	MMS1380S-DIN	39.8	60.5	61.5	107.5	105	2.5	14	2
	3	□	MMS1380S-DIN-C	39.8	60.5	61.5	107.5	105	2.5	14	1
	5	□	MMS1380L-DIN	56.8	77.5	78.5	124.5	122	2.5	14	2
	5	□	MMS1380L-DIN-C	56.8	77.5	78.5	124.5	122	2.5	14	1
	3	★	MMS1380X3DB	43.9	72.5	72.5	128.5	126	2.5	14	1
	5	★	MMS1380X5DB	71.5	100.5	100.5	156.5	154	2.5	14	1
13.9	3	□	MMS1390S-DIN	39.7	60.5	61.5	107.5	105	2.5	14	2
	3	□	MMS1390S-DIN-C	39.7	60.5	61.5	107.5	105	2.5	14	1
	5	□	MMS1390L-DIN	56.7	77.5	78.5	124.5	122	2.5	14	2
	5	□	MMS1390L-DIN-C	56.7	77.5	78.5	124.5	122	2.5	14	1
	3	★	MMS1390X3DB	44.2	72.5	72.5	128.5	126	2.5	14	1
	5	★	MMS1390X5DB	72.0	100.5	100.5	156.5	154	2.5	14	1

DC	Глубина сверления (L/D)	DP7020	Обозначение	Размеры (мм)							Тип
				LU	LCF	LH	OAL	LF	PL	DCON	
14.0	3	□	MMS1400S-DIN	39.5	60.5	61.5	107.5	105	2.5	14	2
	3	●	MMS1400S-DIN-C	39.5	60.5	61.5	107.5	105	2.5	14	1
	5	□	MMS1400L-DIN	56.5	77.5	78.5	124.5	122	2.5	14	2
	5	●	MMS1400L-DIN-C	56.5	77.5	78.5	124.5	122	2.5	14	1
	3	★	MMS1400X3DB	44.5	72.5	72.5	128.5	126	2.5	14	1
	5	★	MMS1400X5DB	72.5	100.5	100.5	156.5	154	2.5	14	1
14.05	3	□	MMS1405S-DIN	43.5	64.6	65.6	114.6	112	2.6	16	2
	3	□	MMS1405S-DIN-C	43.5	64.6	65.6	114.6	112	2.6	16	1
	5	□	MMS1405L-DIN	61.5	82.6	83.6	132.6	130	2.6	16	2
	5	□	MMS1405L-DIN-C	61.5	82.6	83.6	132.6	130	2.6	16	1
14.1	3	□	MMS1410S-DIN	43.4	64.6	65.6	114.6	112	2.6	16	2
	3	□	MMS1410S-DIN-C	43.4	64.6	65.6	114.6	112	2.6	16	1
	5	□	MMS1410L-DIN	61.4	82.6	83.6	132.6	130	2.6	16	2
	5	□	MMS1410L-DIN-C	61.4	82.6	83.6	132.6	130	2.6	16	1
	3	★	MMS1410X3DB	44.9	75.6	78.6	137.6	135	2.6	16	1
5	★	MMS1410X5DB	73.1	104.6	108.6	167.6	165	2.6	16	1	
14.2	3	□	MMS1420S-DIN	43.3	64.6	65.6	114.6	112	2.6	16	2
	3	□	MMS1420S-DIN-C	43.3	64.6	65.6	114.6	112	2.6	16	1
	5	□	MMS1420L-DIN	61.3	82.6	83.6	132.6	130	2.6	16	2
	5	□	MMS1420L-DIN-C	61.3	82.6	83.6	132.6	130	2.6	16	1
	3	★	MMS1420X3DB	45.2	75.6	78.6	137.6	135	2.6	16	1
5	★	MMS1420X5DB	73.6	104.6	108.6	167.6	165	2.6	16	1	
14.3	3	□	MMS1430S-DIN	43.2	64.6	65.6	114.6	112	2.6	16	2
	3	□	MMS1430S-DIN-C	43.2	64.6	65.6	114.6	112	2.6	16	1
	5	□	MMS1430L-DIN	61.2	82.6	83.6	132.6	130	2.6	16	2
	5	□	MMS1430L-DIN-C	61.2	82.6	83.6	132.6	130	2.6	16	1
	3	★	MMS1430X3DB	45.5	75.6	78.6	137.6	135	2.6	16	1
5	★	MMS1430X5DB	74.1	104.6	108.6	167.6	165	2.6	16	1	
14.4	3	□	MMS1440S-DIN	43.0	64.6	65.6	114.6	112	2.6	16	2
	3	□	MMS1440S-DIN-C	43.0	64.6	65.6	114.6	112	2.6	16	1
	5	□	MMS1440L-DIN	61.0	82.6	83.6	132.6	130	2.6	16	2
	5	□	MMS1440L-DIN-C	61.0	82.6	83.6	132.6	130	2.6	16	1
	3	★	MMS1440X3DB	45.8	75.6	78.6	137.6	135	2.6	16	1
5	★	MMS1440X5DB	74.6	104.6	108.6	167.6	165	2.6	16	1	
14.5	3	□	MMS1450S-DIN	42.9	64.6	65.6	114.6	112	2.6	16	2
	3	□	MMS1450S-DIN-C	42.9	64.6	65.6	114.6	112	2.6	16	1
	5	□	MMS1450L-DIN	60.9	82.6	83.6	132.6	130	2.6	16	2
	5	□	MMS1450L-DIN-C	60.9	82.6	83.6	132.6	130	2.6	16	1
	3	★	MMS1450X3DB	46.1	75.6	78.6	137.6	135	2.6	16	1
5	★	MMS1450X5DB	75.1	104.6	108.6	167.6	165	2.6	16	1	
14.6	3	□	MMS1460S-DIN	42.8	64.7	65.7	114.7	112	2.7	16	2
	3	□	MMS1460S-DIN-C	42.8	64.7	65.7	114.7	112	2.7	16	1
	5	□	MMS1460L-DIN	60.8	82.7	83.7	132.7	130	2.7	16	2
	5	□	MMS1460L-DIN-C	60.8	82.7	83.7	132.7	130	2.7	16	1
	3	★	MMS1460X3DB	46.5	77.7	78.7	137.7	135	2.7	16	1
5	★	MMS1460X5DB	75.7	107.7	108.7	167.7	165	2.7	16	1	
14.7	3	□	MMS1470S-DIN	42.6	64.7	65.7	114.7	112	2.7	16	2
	3	□	MMS1470S-DIN-C	42.6	64.7	65.7	114.7	112	2.7	16	1
	5	□	MMS1470L-DIN	60.6	82.7	83.7	132.7	130	2.7	16	2
	5	□	MMS1470L-DIN-C	60.6	82.7	83.7	132.7	130	2.7	16	1
	3	★	MMS1470X3DB	46.8	77.7	78.7	137.7	135	2.7	16	1
5	★	MMS1470X5DB	76.2	107.7	108.7	167.7	165	2.7	16	1	

ИНСТРУМЕНТ ДЛЯ СВЕРЛЕНИЯ (МОНОЛИТНЫЕ ТВЕРДОСПЛАВНЫЕ СВЕРЛА)

MMS

ТВЕРДЫЙ
СПЛАВ

M

ИНСТРУМЕНТ ДЛЯ
СВЕРЛЕНИЯ

DC (мм)	Глубина сверления (L/D)	DP7020	Обозначение	Размеры (мм)							Тип
				LU	LCF	LH	OAL	LF	PL	DCON	
14.8	3	<input type="checkbox"/>	MMS1480S-DIN	42.5	64.7	65.7	114.7	112	2.7	16	2
	3	<input type="checkbox"/>	MMS1480S-DIN-C	42.5	64.7	65.7	114.7	112	2.7	16	1
	5	<input type="checkbox"/>	MMS1480L-DIN	60.5	82.7	83.7	132.7	130	2.7	16	2
	5	<input type="checkbox"/>	MMS1480L-DIN-C	60.5	82.7	83.7	132.7	130	2.7	16	1
	3	★	MMS1480X3DB	47.1	77.7	78.7	137.7	135	2.7	16	1
	5	★	MMS1480X5DB	76.7	107.7	108.7	167.7	165	2.7	16	1
14.9	3	<input type="checkbox"/>	MMS1490S-DIN	42.4	64.7	65.7	114.7	112	2.7	16	2
	3	<input type="checkbox"/>	MMS1490S-DIN-C	42.4	64.7	65.7	114.7	112	2.7	16	1
	5	<input type="checkbox"/>	MMS1490L-DIN	60.4	82.7	83.7	132.7	130	2.7	16	2
	5	<input type="checkbox"/>	MMS1490L-DIN-C	60.4	82.7	83.7	132.7	130	2.7	16	1
	3	★	MMS1490X3DB	47.4	77.7	78.7	137.7	135	2.7	16	1
	5	★	MMS1490X5DB	77.2	107.7	108.7	167.7	165	2.7	16	1
15.0	3	<input type="checkbox"/>	MMS1500S-DIN	42.2	64.7	65.7	114.7	112	2.7	16	2
	3	<input type="checkbox"/>	MMS1500S-DIN-C	42.2	64.7	65.7	114.7	112	2.7	16	1
	5	<input type="checkbox"/>	MMS1500L-DIN	60.2	82.7	83.7	132.7	130	2.7	16	2
	5	<input type="checkbox"/>	MMS1500L-DIN-C	60.2	82.7	83.7	132.7	130	2.7	16	1
	3	★	MMS1500X3DB	47.7	77.7	78.7	137.7	135	2.7	16	1
	5	★	MMS1500X5DB	77.7	107.7	108.7	167.7	165	2.7	16	1
15.1	3	<input type="checkbox"/>	MMS1510S-DIN	42.1	64.7	65.7	114.7	112	2.7	16	2
	3	<input type="checkbox"/>	MMS1510S-DIN-C	42.1	64.7	65.7	114.7	112	2.7	16	1
	5	<input type="checkbox"/>	MMS1510L-DIN	60.1	82.7	83.7	132.7	130	2.7	16	2
	5	<input type="checkbox"/>	MMS1510L-DIN-C	60.1	82.7	83.7	132.7	130	2.7	16	1
	3	★	MMS1510X3DB	48.0	80.7	82.7	141.7	139	2.7	16	1
	5	★	MMS1510X5DB	78.2	111.7	114.7	173.7	171	2.7	16	1
15.2	3	<input type="checkbox"/>	MMS1520S-DIN	42.0	64.8	65.8	114.8	112	2.8	16	2
	3	<input type="checkbox"/>	MMS1520S-DIN-C	42.0	64.8	65.8	114.8	112	2.8	16	1
	5	<input type="checkbox"/>	MMS1520L-DIN	60.0	82.8	83.8	132.8	130	2.8	16	2
	5	<input type="checkbox"/>	MMS1520L-DIN-C	60.0	82.8	83.8	132.8	130	2.8	16	1
	3	★	MMS1520X3DB	48.4	80.8	82.8	141.8	139	2.8	16	1
	5	★	MMS1520X5DB	78.8	111.8	114.8	173.8	171	2.8	16	1
15.3	3	<input type="checkbox"/>	MMS1530S-DIN	41.8	64.8	65.8	114.8	112	2.8	16	2
	3	<input type="checkbox"/>	MMS1530S-DIN-C	41.8	64.8	65.8	114.8	112	2.8	16	1
	5	<input type="checkbox"/>	MMS1530L-DIN	59.8	82.8	83.8	132.8	130	2.8	16	2
	5	<input type="checkbox"/>	MMS1530L-DIN-C	59.8	82.8	83.8	132.8	130	2.8	16	1
	3	★	MMS1530X3DB	48.7	80.8	82.8	141.8	139	2.8	16	1
	5	★	MMS1530X5DB	79.3	111.8	114.8	173.8	171	2.8	16	1
15.4	3	<input type="checkbox"/>	MMS1540S-DIN	41.7	64.8	65.8	114.8	112	2.8	16	2
	3	<input type="checkbox"/>	MMS1540S-DIN-C	41.7	64.8	65.8	114.8	112	2.8	16	1
	5	<input type="checkbox"/>	MMS1540L-DIN	59.7	82.8	83.8	132.8	130	2.8	16	2
	5	<input type="checkbox"/>	MMS1540L-DIN-C	59.7	82.8	83.8	132.8	130	2.8	16	1
	3	★	MMS1540X3DB	49.0	80.8	82.8	141.8	139	2.8	16	1
	5	★	MMS1540X5DB	79.8	111.8	114.8	173.8	171	2.8	16	1
15.5	3	<input type="checkbox"/>	MMS1550S-DIN	41.6	64.8	65.8	114.8	112	2.8	16	2
	3	<input type="checkbox"/>	MMS1550S-DIN-C	41.6	64.8	65.8	114.8	112	2.8	16	1
	5	<input type="checkbox"/>	MMS1550L-DIN	59.6	82.8	83.8	132.8	130	2.8	16	2
	5	<input type="checkbox"/>	MMS1550L-DIN-C	59.6	82.8	83.8	132.8	130	2.8	16	1
	3	★	MMS1550X3DB	49.3	80.8	82.8	141.8	139	2.8	16	1
	5	★	MMS1550X5DB	80.3	111.8	114.8	173.8	171	2.8	16	1

DC (мм)	Глубина сверления (L/D)	DP7020	Обозначение	Размеры (мм)							Тип
				LU	LCF	LH	OAL	LF	PL	DCON	
15.6	3	<input type="checkbox"/>	MMS1560S-DIN	41.4	64.8	65.8	114.8	112	2.8	16	2
	3	<input type="checkbox"/>	MMS1560S-DIN-C	41.4	64.8	65.8	114.8	112	2.8	16	1
	5	<input type="checkbox"/>	MMS1560L-DIN	59.4	82.8	83.8	132.8	130	2.8	16	2
	5	<input type="checkbox"/>	MMS1560L-DIN-C	59.4	82.8	83.8	132.8	130	2.8	16	1
	3	★	MMS1560X3DB	49.6	82.8	82.8	141.8	139	2.8	16	1
	5	★	MMS1560X5DB	80.8	114.8	114.8	173.8	171	2.8	16	1
15.7	3	<input type="checkbox"/>	MMS1570S-DIN	41.3	64.9	65.9	114.9	112	2.9	16	2
	3	<input type="checkbox"/>	MMS1570S-DIN-C	41.3	64.9	65.9	114.9	112	2.9	16	1
	5	<input type="checkbox"/>	MMS1570L-DIN	59.3	82.9	83.9	132.9	130	2.9	16	2
	5	<input type="checkbox"/>	MMS1570L-DIN-C	59.3	82.9	83.9	132.9	130	2.9	16	1
	3	★	MMS1570X3DB	50.0	82.9	82.9	141.9	139	2.9	16	1
	5	★	MMS1570X5DB	81.4	114.9	114.9	173.9	171	2.9	16	1
15.8	3	<input type="checkbox"/>	MMS1580S-DIN	41.2	64.9	65.9	114.9	112	2.9	16	2
	3	<input type="checkbox"/>	MMS1580S-DIN-C	41.2	64.9	65.9	114.9	112	2.9	16	1
	5	<input type="checkbox"/>	MMS1580L-DIN	59.2	82.9	83.9	132.9	130	2.9	16	2
	5	<input type="checkbox"/>	MMS1580L-DIN-C	59.2	82.9	83.9	132.9	130	2.9	16	1
	3	★	MMS1580X3DB	50.3	82.9	82.9	141.9	139	2.9	16	1
	5	★	MMS1580X5DB	81.9	114.9	114.9	173.9	171	2.9	16	1
15.9	3	<input type="checkbox"/>	MMS1590S-DIN	41.0	64.9	65.9	114.9	112	2.9	16	2
	3	<input type="checkbox"/>	MMS1590S-DIN-C	41.0	64.9	65.9	114.9	112	2.9	16	1
	5	<input type="checkbox"/>	MMS1590L-DIN	59.0	82.9	83.9	132.9	130	2.9	16	2
	5	<input type="checkbox"/>	MMS1590L-DIN-C	59.0	82.9	83.9	132.9	130	2.9	16	1
	3	★	MMS1590X3DB	50.6	82.9	82.9	141.9	139	2.9	16	1
	5	★	MMS1590X5DB	82.4	114.9	114.9	173.9	171	2.9	16	1
16.0	3	<input type="checkbox"/>	MMS1600S-DIN	40.9	64.9	65.9	114.9	112	2.9	16	2
	3	<input type="checkbox"/>	MMS1600S-DIN-C	40.9	64.9	65.9	114.9	112	2.9	16	1
	5	<input type="checkbox"/>	MMS1600L-DIN	58.9	82.9	83.9	132.9	130	2.9	16	2
	5	<input type="checkbox"/>	MMS1600L-DIN-C	58.9	82.9	83.9	132.9	130	2.9	16	1
	3	★	MMS1600X3DB	50.9	82.9	82.9	141.9	139	2.9	16	1
	5	★	MMS1600X5DB	82.9	114.9	114.9	173.9	171	2.9	16	1
16.1	3	<input type="checkbox"/>	MMS1610S-DIN	48.8	72.9	73.9	122.9	120	2.9	18	2
	3	<input type="checkbox"/>	MMS1610S-DIN-C	48.8	72.9	73.9	122.9	120	2.9	18	1
	5	<input type="checkbox"/>	MMS1610L-DIN	68.8	92.9	93.9	142.9	140	2.9	18	2
	5	<input type="checkbox"/>	MMS1610L-DIN-C	68.8	92.9	93.9	142.9	140	2.9	18	1
	3	<input type="checkbox"/>	MMS1610X3DB	51.2	85.9	88.9	147.9	145	2.9	18	1
	5	<input type="checkbox"/>	MMS1610X5DB	83.4	118.9	122.9	181.9	179	2.9	18	1
16.2	3	<input type="checkbox"/>	MMS1620S-DIN	48.6	72.9	73.9	122.9	120	2.9	18	2
	3	<input type="checkbox"/>	MMS1620S-DIN-C	48.6	72.9	73.9	122.9	120	2.9	18	1
	5	<input type="checkbox"/>	MMS1620L-DIN	68.6	92.9	93.9	142.9	140	2.9	18	2
	5	<input type="checkbox"/>	MMS1620L-DIN-C	68.6	92.9	93.9	142.9	140	2.9	18	1
	3	<input type="checkbox"/>	MMS1620X3DB	51.5	85.9	88.9	147.9	145	2.9	18	1
	5	<input type="checkbox"/>	MMS1620X5DB	83.9	118.9	122.9	181.9	179	2.9	18	1
16.3	3	<input type="checkbox"/>	MMS1630S-DIN	48.5	73.0	74.0	123.0	120	3.0	18	2
	3	<input type="checkbox"/>	MMS1630S-DIN-C	48.5	73.0	74.0	123.0	120	3.0	18	1
	5	<input type="checkbox"/>	MMS1630L-DIN	68.5	93.0	94.0	143.0	140	3.0	18	2
	5	<input type="checkbox"/>	MMS1630L-DIN-C	68.5	93.0	94.0	143.0	140	3.0	18	1
	3	<input type="checkbox"/>	MMS1630X3DB	51.9	86.0	89.0	148.0	145	3.0	18	1
	5	<input type="checkbox"/>	MMS1630X5DB	84.5	119.0	123.0	182.0	179	3.0	18	1

★ : Со склада в Японии. □ : Нет на складе, выпускается исключительно под заказ.

DC (мм)	Глубина сверления (L/D)	DP7020	Обозначение	Размеры (мм)							Тип
				LU	LCF	LH	OAL	LF	PL	DCON	
16.4	3	□	MMS1640S-DIN	48.4	73.0	74.0	123.0	120	3.0	18	2
	3	□	MMS1640S-DIN-C	48.4	73.0	74.0	123.0	120	3.0	18	1
	5	□	MMS1640L-DIN	68.4	93.0	94.0	143.0	140	3.0	18	2
	5	□	MMS1640L-DIN-C	68.4	93.0	94.0	143.0	140	3.0	18	1
	3	□	MMS1640X3DB	52.2	86.0	89.0	148.0	145	3.0	18	1
	5	□	MMS1640X5DB	85.0	119.0	123.0	182.0	179	3.0	18	1
16.5	3	□	MMS1650S-DIN	48.3	73.0	74.0	123.0	120	3.0	18	2
	3	□	MMS1650S-DIN-C	48.3	73.0	74.0	123.0	120	3.0	18	1
	5	□	MMS1650L-DIN	68.3	93.0	94.0	143.0	140	3.0	18	2
	5	□	MMS1650L-DIN-C	68.3	93.0	94.0	143.0	140	3.0	18	1
	3	★	MMS1650X3DB	52.5	86.0	89.0	148.0	145	3.0	18	1
	5	★	MMS1650X5DB	85.5	119.0	123.0	182.0	179	3.0	18	1
16.6	3	□	MMS1660S-DIN	48.1	73.0	74.0	123.0	120	3.0	18	2
	3	□	MMS1660S-DIN-C	48.1	73.0	74.0	123.0	120	3.0	18	1
	5	□	MMS1660L-DIN	68.1	93.0	94.0	143.0	140	3.0	18	2
	5	□	MMS1660L-DIN-C	68.1	93.0	94.0	143.0	140	3.0	18	1
	3	□	MMS1660X3DB	52.8	88.0	89.0	148.0	145	3.0	18	1
	5	□	MMS1660X5DB	86.0	122.0	123.0	182.0	179	3.0	18	1
16.7	3	□	MMS1670S-DIN	48.0	73.0	74.0	123.0	120	3.0	18	2
	3	□	MMS1670S-DIN-C	48.0	73.0	74.0	123.0	120	3.0	18	1
	5	□	MMS1670L-DIN	68.0	93.0	94.0	143.0	140	3.0	18	2
	5	□	MMS1670L-DIN-C	68.0	93.0	94.0	143.0	140	3.0	18	1
	3	□	MMS1670X3DB	53.1	88.0	89.0	148.0	145	3.0	18	1
	5	□	MMS1670X5DB	86.5	122.0	123.0	182.0	179	3.0	18	1
16.8	3	□	MMS1680S-DIN	47.9	73.1	74.1	123.1	120	3.1	18	2
	3	□	MMS1680S-DIN-C	47.9	73.1	74.1	123.1	120	3.1	18	1
	5	□	MMS1680L-DIN	67.9	93.1	94.1	143.1	140	3.1	18	2
	5	□	MMS1680L-DIN-C	67.9	93.1	94.1	143.1	140	3.1	18	1
	3	□	MMS1680X3DB	53.5	88.1	89.1	148.1	145	3.1	18	1
	5	□	MMS1680X5DB	87.1	122.1	123.1	182.1	179	3.1	18	1
16.9	3	□	MMS1690S-DIN	47.7	73.1	74.1	123.1	120	3.1	18	2
	3	□	MMS1690S-DIN-C	47.7	73.1	74.1	123.1	120	3.1	18	1
	5	□	MMS1690L-DIN	67.7	93.1	94.1	143.1	140	3.1	18	2
	5	□	MMS1690L-DIN-C	67.7	93.1	94.1	143.1	140	3.1	18	1
	3	□	MMS1690X3DB	53.8	88.1	89.1	148.1	145	3.1	18	1
	5	□	MMS1690X5DB	87.6	122.1	123.1	182.1	179	3.1	18	1
17.0	3	□	MMS1700S-DIN	47.6	73.1	74.1	123.1	120	3.1	18	2
	3	□	MMS1700S-DIN-C	47.6	73.1	74.1	123.1	120	3.1	18	1
	5	□	MMS1700L-DIN	67.6	93.1	94.1	143.1	140	3.1	18	2
	5	□	MMS1700L-DIN-C	67.6	93.1	94.1	143.1	140	3.1	18	1
	3	★	MMS1700X3DB	54.1	88.1	89.1	148.1	145	3.1	18	1
	5	★	MMS1700X5DB	88.1	122.1	123.1	182.1	179	3.1	18	1
17.1	3	□	MMS1710S-DIN	47.5	73.1	74.1	123.1	120	3.1	18	2
	3	□	MMS1710S-DIN-C	47.5	73.1	74.1	123.1	120	3.1	18	1
	5	□	MMS1710L-DIN	67.5	93.1	94.1	143.1	140	3.1	18	2
	5	□	MMS1710L-DIN-C	67.5	93.1	94.1	143.1	140	3.1	18	1
	3	□	MMS1710X3DB	54.4	91.1	93.1	152.1	149	3.1	18	1
	5	□	MMS1710X5DB	88.6	126.1	129.1	188.1	185	3.1	18	1

DC (мм)	Глубина сверления (L/D)	DP7020	Обозначение	Размеры (мм)							Тип
				LU	LCF	LH	OAL	LF	PL	DCON	
17.2	3	□	MMS1720S-DIN	47.3	73.1	74.1	123.1	120	3.1	18	2
	3	□	MMS1720S-DIN-C	47.3	73.1	74.1	123.1	120	3.1	18	1
	5	□	MMS1720L-DIN	67.3	93.1	94.1	143.1	140	3.1	18	2
	5	□	MMS1720L-DIN-C	67.3	93.1	94.1	143.1	140	3.1	18	1
	3	□	MMS1720X3DB	54.7	91.1	93.1	152.1	149	3.1	18	1
	5	□	MMS1720X5DB	89.1	126.1	129.1	188.1	185	3.1	18	1
17.3	3	□	MMS1730S-DIN	47.2	73.1	74.1	123.1	120	3.1	18	2
	3	□	MMS1730S-DIN-C	47.2	73.1	74.1	123.1	120	3.1	18	1
	5	□	MMS1730L-DIN	67.2	93.1	94.1	143.1	140	3.1	18	2
	5	□	MMS1730L-DIN-C	67.2	93.1	94.1	143.1	140	3.1	18	1
	3	□	MMS1730X3DB	55.0	91.1	93.1	152.1	149	3.1	18	1
	5	□	MMS1730X5DB	89.6	126.1	129.1	188.1	185	3.1	18	1
17.4	3	□	MMS1740S-DIN	47.1	73.2	74.2	123.2	120	3.2	18	2
	3	□	MMS1740S-DIN-C	47.1	73.2	74.2	123.2	120	3.2	18	1
	5	□	MMS1740L-DIN	67.1	93.2	94.2	143.2	140	3.2	18	2
	5	□	MMS1740L-DIN-C	67.1	93.2	94.2	143.2	140	3.2	18	1
	3	□	MMS1740X3DB	55.4	91.2	93.2	152.2	149	3.2	18	1
	5	□	MMS1740X5DB	90.2	126.2	129.2	188.2	185	3.2	18	1
17.5	3	□	MMS1750S-DIN	46.9	73.2	74.2	123.2	120	3.2	18	2
	3	□	MMS1750S-DIN-C	46.9	73.2	74.2	123.2	120	3.2	18	1
	5	□	MMS1750L-DIN	66.9	93.2	94.2	143.2	140	3.2	18	2
	5	□	MMS1750L-DIN-C	66.9	93.2	94.2	143.2	140	3.2	18	1
	3	★	MMS1750X3DB	55.7	91.2	93.2	152.2	149	3.2	18	1
	5	★	MMS1750X5DB	90.7	126.2	129.2	188.2	185	3.2	18	1
17.6	3	□	MMS1760S-DIN	46.8	73.2	74.2	123.2	120	3.2	18	2
	3	□	MMS1760S-DIN-C	46.8	73.2	74.2	123.2	120	3.2	18	1
	5	□	MMS1760L-DIN	66.8	93.2	94.2	143.2	140	3.2	18	2
	5	□	MMS1760L-DIN-C	66.8	93.2	94.2	143.2	140	3.2	18	1
	3	□	MMS1760X3DB	56.0	93.2	93.2	152.2	149	3.2	18	1
	5	□	MMS1760X5DB	91.2	129.2	129.2	188.2	185	3.2	18	1
17.7	3	□	MMS1770S-DIN	46.7	73.2	74.2	123.2	120	3.2	18	2
	3	□	MMS1770S-DIN-C	46.7	73.2	74.2	123.2	120	3.2	18	1
	5	□	MMS1770L-DIN	66.7	93.2	94.2	143.2	140	3.2	18	2
	5	□	MMS1770L-DIN-C	66.7	93.2	94.2	143.2	140	3.2	18	1
	3	□	MMS1770X3DB	56.3	93.2	93.2	152.2	149	3.2	18	1
	5	□	MMS1770X5DB	91.7	129.2	129.2	188.2	185	3.2	18	1
17.8	3	□	MMS1780S-DIN	46.5	73.2	74.2	123.2	120	3.2	18	2
	3	□	MMS1780S-DIN-C	46.5	73.2	74.2	123.2	120	3.2	18	1
	5	□	MMS1780L-DIN	66.5	93.2	94.2	143.2	140	3.2	18	2
	5	□	MMS1780L-DIN-C	66.5	93.2	94.2	143.2	140	3.2	18	1
	3	□	MMS1780X3DB	56.6	93.2	93.2	152.2	149	3.2	18	1
	5	□	MMS1780X5DB	92.2	129.2	129.2	188.2	185	3.2	18	1
17.9	3	□	MMS1790S-DIN	46.4	73.3	74.3	123.3	120	3.3	18	2
	3	□	MMS1790S-DIN-C	46.4	73.3	74.3	123.3	120	3.3	18	1
	5	□	MMS1790L-DIN	66.4	93.3	94.3	143.3	140	3.3	18	2
	5	□	MMS1790L-DIN-C	66.4	93.3	94.3	143.3	140	3.3	18	1
	3	□	MMS1790X3DB	57.0	93.3	93.3	152.3	149	3.3	18	1
	5	□	MMS1790X5DB	92.8	129.3	129.3	188.3	185	3.3	18	1

М
ИНСТРУМЕНТ ДЛЯ
СВЕРЛЕНИЯ

ИНСТРУМЕНТ ДЛЯ СВЕРЛЕНИЯ (МОНОЛИТНЫЕ ТВЕРДОСПЛАВНЫЕ СВЕРЛА)

MMS

ТВЕРДЫЙ
СПЛАВ

M

ИНСТРУМЕНТ ДЛЯ
СВЕРЛЕНИЯ

DC (мм)	Глубина сверления (L/D)	DP7020	Обозначение	Размеры (мм)							Тип
				LU	LCF	LH	OAL	LF	PL	DCON	
18.0	3	<input type="checkbox"/>	MMS1800S-DIN	46.3	73.3	74.3	123.3	120	3.3	18	2
	3	<input type="checkbox"/>	MMS1800S-DIN-C	46.3	73.3	74.3	123.3	120	3.3	18	1
	5	<input type="checkbox"/>	MMS1800L-DIN	66.3	93.3	94.3	143.3	140	3.3	18	2
	5	<input type="checkbox"/>	MMS1800L-DIN-C	66.3	93.3	94.3	143.3	140	3.3	18	1
	3	★	MMS1800X3DB	57.3	93.3	93.3	152.3	149	3.3	18	1
	5	★	MMS1800X5DB	93.3	129.3	129.3	188.3	185	3.3	18	1
18.1	3	<input type="checkbox"/>	MMS1810S-DIN	52.1	79.3	80.3	131.3	128	3.3	20	2
	3	<input type="checkbox"/>	MMS1810S-DIN-C	52.1	79.3	80.3	131.3	128	3.3	20	1
	5	<input type="checkbox"/>	MMS1810L-DIN	74.1	101.3	102.3	153.3	150	3.3	20	2
	5	<input type="checkbox"/>	MMS1810L-DIN-C	74.1	101.3	102.3	153.3	150	3.3	20	1
	3	<input type="checkbox"/>	MMS1810X3DB	57.6	96.3	99.3	160.3	157	3.3	20	1
	5	<input type="checkbox"/>	MMS1810X5DB	93.8	133.3	137.3	198.3	195	3.3	20	1
18.2	3	<input type="checkbox"/>	MMS1820S-DIN	52.0	79.3	80.3	131.3	128	3.3	20	2
	3	<input type="checkbox"/>	MMS1820S-DIN-C	52.0	79.3	80.3	131.3	128	3.3	20	1
	5	<input type="checkbox"/>	MMS1820L-DIN	74.0	101.3	102.3	153.3	150	3.3	20	2
	5	<input type="checkbox"/>	MMS1820L-DIN-C	74.0	101.3	102.3	153.3	150	3.3	20	1
	3	<input type="checkbox"/>	MMS1820X3DB	57.9	96.3	99.3	160.3	157	3.3	20	1
	5	<input type="checkbox"/>	MMS1820X5DB	94.3	133.3	137.3	198.3	195	3.3	20	1
18.3	3	<input type="checkbox"/>	MMS1830S-DIN	51.9	79.3	80.3	131.3	128	3.3	20	2
	3	<input type="checkbox"/>	MMS1830S-DIN-C	51.9	79.3	80.3	131.3	128	3.3	20	1
	5	<input type="checkbox"/>	MMS1830L-DIN	73.9	101.3	102.3	153.3	150	3.3	20	2
	5	<input type="checkbox"/>	MMS1830L-DIN-C	73.9	101.3	102.3	153.3	150	3.3	20	1
	3	<input type="checkbox"/>	MMS1830X3DB	58.2	96.3	99.3	160.3	157	3.3	20	1
	5	<input type="checkbox"/>	MMS1830X5DB	94.8	133.3	137.3	198.3	195	3.3	20	1
18.4	3	<input type="checkbox"/>	MMS1840S-DIN	51.7	79.3	80.3	131.3	128	3.3	20	2
	3	<input type="checkbox"/>	MMS1840S-DIN-C	51.7	79.3	80.3	131.3	128	3.3	20	1
	5	<input type="checkbox"/>	MMS1840L-DIN	73.7	101.3	102.3	153.3	150	3.3	20	2
	5	<input type="checkbox"/>	MMS1840L-DIN-C	73.7	101.3	102.3	153.3	150	3.3	20	1
	3	<input type="checkbox"/>	MMS1840X3DB	58.5	96.3	99.3	160.3	157	3.3	20	1
	5	<input type="checkbox"/>	MMS1840X5DB	95.3	133.3	137.3	198.3	195	3.3	20	1
18.5	3	<input type="checkbox"/>	MMS1850S-DIN	51.6	79.4	80.4	131.4	128	3.4	20	2
	3	<input type="checkbox"/>	MMS1850S-DIN-C	51.6	79.4	80.4	131.4	128	3.4	20	1
	5	<input type="checkbox"/>	MMS1850L-DIN	73.6	101.4	102.4	153.4	150	3.4	20	2
	5	<input type="checkbox"/>	MMS1850L-DIN-C	73.6	101.4	102.4	153.4	150	3.4	20	1
	3	★	MMS1850X3DB	58.9	96.4	99.4	160.4	157	3.4	20	1
	5	★	MMS1850X5DB	95.9	133.4	137.4	198.4	195	3.4	20	1
18.6	3	<input type="checkbox"/>	MMS1860S-DIN	51.5	79.4	80.4	131.4	128	3.4	20	2
	3	<input type="checkbox"/>	MMS1860S-DIN-C	51.5	79.4	80.4	131.4	128	3.4	20	1
	5	<input type="checkbox"/>	MMS1860L-DIN	73.5	101.4	102.4	153.4	150	3.4	20	2
	5	<input type="checkbox"/>	MMS1860L-DIN-C	73.5	101.4	102.4	153.4	150	3.4	20	1
	3	<input type="checkbox"/>	MMS1860X3DB	59.2	98.4	99.4	160.4	157	3.4	20	1
	5	<input type="checkbox"/>	MMS1860X5DB	96.4	136.4	137.4	198.4	195	3.4	20	1
18.7	3	<input type="checkbox"/>	MMS1870S-DIN	51.4	79.4	80.4	131.4	128	3.4	20	2
	3	<input type="checkbox"/>	MMS1870S-DIN-C	51.4	79.4	80.4	131.4	128	3.4	20	1
	5	<input type="checkbox"/>	MMS1870L-DIN	73.4	101.4	102.4	153.4	150	3.4	20	2
	5	<input type="checkbox"/>	MMS1870L-DIN-C	73.4	101.4	102.4	153.4	150	3.4	20	1
	3	<input type="checkbox"/>	MMS1870X3DB	59.5	98.4	99.4	160.4	157	3.4	20	1
	5	<input type="checkbox"/>	MMS1870X5DB	96.9	136.4	137.4	198.4	195	3.4	20	1

DC (мм)	Глубина сверления (L/D)	DP7020	Обозначение	Размеры (мм)							Тип
				LU	LCF	LH	OAL	LF	PL	DCON	
18.8	3	<input type="checkbox"/>	MMS1880S-DIN	51.2	79.4	80.4	131.4	128	3.4	20	2
	3	<input type="checkbox"/>	MMS1880S-DIN-C	51.2	79.4	80.4	131.4	128	3.4	20	1
	5	<input type="checkbox"/>	MMS1880L-DIN	73.2	101.4	102.4	153.4	150	3.4	20	2
	5	<input type="checkbox"/>	MMS1880L-DIN-C	73.2	101.4	102.4	153.4	150	3.4	20	1
	3	<input type="checkbox"/>	MMS1880X3DB	59.8	98.4	99.4	160.4	157	3.4	20	1
	5	<input type="checkbox"/>	MMS1880X5DB	97.4	136.4	137.4	198.4	195	3.4	20	1
18.9	3	<input type="checkbox"/>	MMS1890S-DIN	51.1	79.4	80.4	131.4	128	3.4	20	2
	3	<input type="checkbox"/>	MMS1890S-DIN-C	51.1	79.4	80.4	131.4	128	3.4	20	1
	5	<input type="checkbox"/>	MMS1890L-DIN	73.1	101.4	102.4	153.4	150	3.4	20	2
	5	<input type="checkbox"/>	MMS1890L-DIN-C	73.1	101.4	102.4	153.4	150	3.4	20	1
	3	<input type="checkbox"/>	MMS1890X3DB	60.1	98.4	99.4	160.4	157	3.4	20	1
	5	<input type="checkbox"/>	MMS1890X5DB	97.9	136.4	137.4	198.4	195	3.4	20	1
19.0	3	<input type="checkbox"/>	MMS1900S-DIN	51.0	79.5	80.5	131.5	128	3.5	20	2
	3	<input type="checkbox"/>	MMS1900S-DIN-C	51.0	79.5	80.5	131.5	128	3.5	20	1
	5	<input type="checkbox"/>	MMS1900L-DIN	73.0	101.5	102.5	153.5	150	3.5	20	2
	5	<input type="checkbox"/>	MMS1900L-DIN-C	73.0	101.5	102.5	153.5	150	3.5	20	1
	3	★	MMS1900X3DB	60.5	98.5	99.5	160.5	157	3.5	20	1
	5	★	MMS1900X5DB	98.5	136.5	137.5	198.5	195	3.5	20	1
19.1	3	<input type="checkbox"/>	MMS1910S-DIN	50.8	79.5	80.5	131.5	128	3.5	20	2
	3	<input type="checkbox"/>	MMS1910S-DIN-C	50.8	79.5	80.5	131.5	128	3.5	20	1
	5	<input type="checkbox"/>	MMS1910L-DIN	72.8	101.5	102.5	153.5	150	3.5	20	2
	5	<input type="checkbox"/>	MMS1910L-DIN-C	72.8	101.5	102.5	153.5	150	3.5	20	1
	3	<input type="checkbox"/>	MMS1910X3DB	60.8	101.5	103.5	164.5	161	3.5	20	1
	5	<input type="checkbox"/>	MMS1910X5DB	99.0	140.5	143.5	204.5	201	3.5	20	1
19.2	3	<input type="checkbox"/>	MMS1920S-DIN	50.7	79.5	80.5	131.5	128	3.5	20	2
	3	<input type="checkbox"/>	MMS1920S-DIN-C	50.7	79.5	80.5	131.5	128	3.5	20	1
	5	<input type="checkbox"/>	MMS1920L-DIN	72.7	101.5	102.5	153.5	150	3.5	20	2
	5	<input type="checkbox"/>	MMS1920L-DIN-C	72.7	101.5	102.5	153.5	150	3.5	20	1
	3	<input type="checkbox"/>	MMS1920X3DB	61.1	101.5	103.5	164.5	161	3.5	20	1
	5	<input type="checkbox"/>	MMS1920X5DB	99.5	140.5	143.5	204.5	201	3.5	20	1
19.3	3	<input type="checkbox"/>	MMS1930S-DIN	50.6	79.5	80.5	131.5	128	3.5	20	2
	3	<input type="checkbox"/>	MMS1930S-DIN-C	50.6	79.5	80.5	131.5	128	3.5	20	1
	5	<input type="checkbox"/>	MMS1930L-DIN	72.6	101.5	102.5	153.5	150	3.5	20	2
	5	<input type="checkbox"/>	MMS1930L-DIN-C	72.6	101.5	102.5	153.5	150	3.5	20	1
	3	<input type="checkbox"/>	MMS1930X3DB	61.4	101.5	103.5	164.5	161	3.5	20	1
	5	<input type="checkbox"/>	MMS1930X5DB	100.0	140.5	143.5	204.5	201	3.5	20	1
19.4	3	<input type="checkbox"/>	MMS1940S-DIN	50.4	79.5	80.5	131.5	128	3.5	20	2
	3	<input type="checkbox"/>	MMS1940S-DIN-C	50.4	79.5	80.5	131.5	128	3.5	20	1
	5	<input type="checkbox"/>	MMS1940L-DIN	72.4	101.5	102.5	153.5	150	3.5	20	2
	5	<input type="checkbox"/>	MMS1940L-DIN-C	72.4	101.5	102.5	153.5	150	3.5	20	1
	3	<input type="checkbox"/>	MMS1940X3DB	61.7	101.5	103.5	164.5	161	3.5	20	1
	5	<input type="checkbox"/>	MMS1940X5DB	100.5	140.5	143.5	204.5	201	3.5	20	1
19.5	3	<input type="checkbox"/>	MMS1950S-DIN	50.3	79.5	80.5	131.5	128	3.5	20	2
	3	<input type="checkbox"/>	MMS1950S-DIN-C	50.3	79.5	80.5	131.5	128	3.5	20	1
	5	<input type="checkbox"/>	MMS1950L-DIN	72.3	101.5	102.5	153.5	150	3.5	20	2
	5	<input type="checkbox"/>	MMS1950L-DIN-C	72.3	101.5	102.5	153.5	150	3.5	20	1
	3	★	MMS1950X3DB	62.0	101.5	103.5	164.5	161	3.5	20	1
	5	★	MMS1950X5DB	101.0	140.5	143.5	204.5	201	3.5	20	1

★ : Со склада в Японии. □ : Нет на складе, выпускается исключительно под заказ.

DC (мм)	Глубина сверления (L/D)	DP7020	Обозначение	Размеры (мм)							Тип
				LU	LCF	LH	OAL	LF	PL	DCON	
19.6	3	□	MMS1960S-DIN	50.2	79.6	80.6	131.6	128	3.6	20	2
	3	□	MMS1960S-DIN-C	50.2	79.6	80.6	131.6	128	3.6	20	1
	5	□	MMS1960L-DIN	72.2	101.6	102.6	153.6	150	3.6	20	2
	5	□	MMS1960L-DIN-C	72.2	101.6	102.6	153.6	150	3.6	20	1
	3	□	MMS1960X3DB	62.4	103.6	103.6	164.6	161	3.6	20	1
	5	□	MMS1960X5DB	101.6	143.6	143.6	204.6	201	3.6	20	1
19.7	3	□	MMS1970S-DIN	50.0	79.6	80.6	131.6	128	3.6	20	2
	3	□	MMS1970S-DIN-C	50.0	79.6	80.6	131.6	128	3.6	20	1
	5	□	MMS1970L-DIN	72.0	101.6	102.6	153.6	150	3.6	20	2
	5	□	MMS1970L-DIN-C	72.0	101.6	102.6	153.6	150	3.6	20	1
	3	□	MMS1970X3DB	62.7	103.6	103.6	164.6	161	3.6	20	1
	5	□	MMS1970X5DB	102.1	143.6	143.6	204.6	201	3.6	20	1
19.8	3	□	MMS1980S-DIN	49.9	79.6	80.6	131.6	128	3.6	20	2
	3	□	MMS1980S-DIN-C	49.9	79.6	80.6	131.6	128	3.6	20	1
	5	□	MMS1980L-DIN	71.9	101.6	102.6	153.6	150	3.6	20	2
	5	□	MMS1980L-DIN-C	71.9	101.6	102.6	153.6	150	3.6	20	1
	3	□	MMS1980X3DB	63.0	103.6	103.6	164.6	161	3.6	20	1
	5	□	MMS1980X5DB	102.6	143.6	143.6	204.6	201	3.6	20	1

DC (мм)	Глубина сверления (L/D)	DP7020	Обозначение	Размеры (мм)							Тип
				LU	LCF	LH	OAL	LF	PL	DCON	
19.9	3	□	MMS1990S-DIN	49.8	79.6	80.6	131.6	128	3.6	20	2
	3	□	MMS1990S-DIN-C	49.8	79.6	80.6	131.6	128	3.6	20	1
	5	□	MMS1990L-DIN	71.8	101.6	102.6	153.6	150	3.6	20	2
	5	□	MMS1990L-DIN-C	71.8	101.6	102.6	153.6	150	3.6	20	1
	3	□	MMS1990X3DB	63.3	103.6	103.6	164.6	161	3.6	20	1
	5	□	MMS1990X5DB	103.1	143.6	143.6	204.6	201	3.6	20	1
20.0	3	□	MMS2000S-DIN	49.6	79.6	80.6	131.6	128	3.6	20	2
	3	□	MMS2000S-DIN-C	49.6	79.6	80.6	131.6	128	3.6	20	1
	5	□	MMS2000L-DIN	71.6	101.6	102.6	153.6	150	3.6	20	2
	5	□	MMS2000L-DIN-C	71.6	101.6	102.6	153.6	150	3.6	20	1
	3	★	MMS2000X3DB	63.6	103.6	103.6	164.6	161	3.6	20	1
	5	★	MMS2000X5DB	103.6	143.6	143.6	204.6	201	3.6	20	1

ИНСТРУКЦИЯ ПО ЭКСПЛУАТАЦИИ

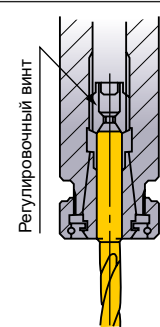
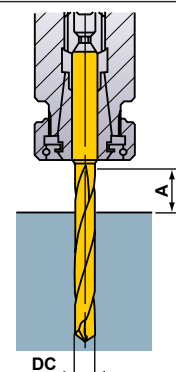
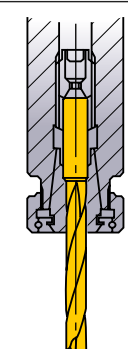
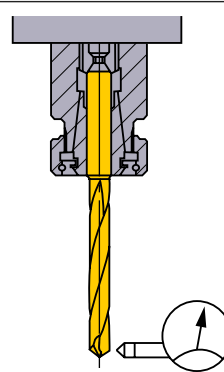
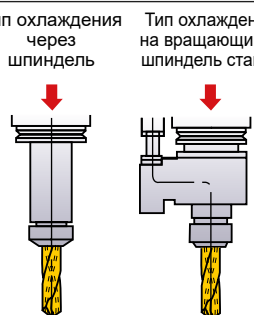
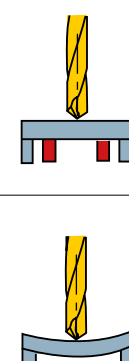
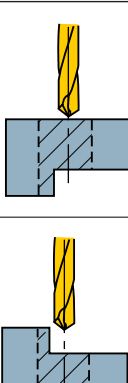
<p>Крепление сверла</p>  <p>Регулируемый винт</p> <p>Цанговый патрон с упорным подшипником надежно держит сверло.</p>	<p>Длина сверла</p>  <p>$A \geq DC \times 1.5$</p>	<p>Установка сверла</p>  <p>Не прижимать по режущей кромке.</p>	<p>Допуск на установку</p>  <p>Биение $\leq 0.03\text{мм}$</p>
<p>Тип охлаждения через сквозные отверстия</p>  <p>Тип охлаждения через шпиндель</p> <p>Тип охлаждения на вращающийся шпиндель станка</p> <p>Давление охлаждающей среды должно составлять ок. 5 Бар—70 Бар</p>	<p>Рекомендации по использованию СОЖ</p> <ol style="list-style-type: none"> 1) Рекомендуется регулярно проводить замену СОЖ во избежании забивания каналов в сверле. 2) Для предотвращения забивания мелкой стружкой отверстий сверла используйте фильтр, как профилактическую меру. Для сверл малого диаметра рекомендуется применять фильтр с более мелкими отверстиями. 	<p>Тонкая заготовка</p>  <p>OK Необходима опора для заготовки.</p> <p>X Если наблюдается отгиб.</p>	<p>Прерывистое резание</p>  <p>Один процесс OK</p> <p>① Уменьшить подачу при сверлении ступенчатой детали (при прерывистом сверлении).</p> <p>Требуется предварительная обработка.</p> <p>① До сверления предварительно подрезать торец концевой фрезой.</p>

РЕКОМЕНДУЕМЫЕ РЕЖИМЫ РЕЗАНИЯ

Обрабатываемый материал	M									
	Аустенитная нержавеющая сталь ($\leq 180\text{HB}$) X5CrNi1810, X5CrNiMo17-12-2					Аустенитная нержавеющая сталь (180—280HB) X2CrNiN1810, X2CrNiMoN17-12-2				
Диам. сверла DC (мм)	Скорость резания (м/мин)	Частота вращения (мин ⁻¹)	Подача (мин.—макс.) (мм/об)		Подача (мм/мин)	Скорость резания (м/мин)	Частота вращения (мин ⁻¹)	Подача (мин.—макс.) (мм/об)		Подача (мм/мин)
3.2	80	7900	0.13	(0.08—0.18)	1025	60	5900	0.10	(0.05—0.15)	590
4.0	80	6300	0.15	(0.10—0.20)	945	60	4700	0.12	(0.08—0.18)	560
5.0	80	5000	0.15	(0.10—0.20)	750	60	3800	0.12	(0.08—0.18)	455
6.3	80	4000	0.17	(0.12—0.22)	680	60	3000	0.15	(0.10—0.20)	450
8.0	80	3100	0.19	(0.14—0.24)	585	60	2300	0.17	(0.12—0.22)	390
10.0	60	1900	0.20	(0.15—0.25)	380	50	1500	0.18	(0.13—0.23)	270
12.0	60	1500	0.21	(0.16—0.26)	315	50	1300	0.19	(0.14—0.24)	245
16.0	60	1100	0.22	(0.17—0.27)	240	50	900	0.20	(0.15—0.25)	180
20.0	60	900	0.23	(0.18—0.28)	205	50	700	0.21	(0.16—0.26)	145

Обрабатываемый материал	M									
	Ферро-аустенитная нержавеющая сталь ($\leq 280\text{HB}$) X3CrNiMoN27-5-2					Ферритная и мартенситная нержавеющая сталь ($\leq 200\text{HB}$) X10Cr13, X6Cr17				
Диам. сверла DC (мм)	Скорость резания (м/мин)	Частота вращения (мин ⁻¹)	Подача (мин.—макс.) (мм/об)		Подача (мм/мин)	Скорость резания (м/мин)	Частота вращения (мин ⁻¹)	Подача (мин.—макс.) (мм/об)		Подача (мм/мин)
3.2	50	4900	0.10	(0.05—0.15)	490	80	7900	0.13	(0.08—0.18)	1025
4.0	50	3900	0.12	(0.08—0.18)	465	80	6300	0.15	(0.10—0.20)	945
5.0	50	3100	0.12	(0.08—0.18)	370	80	5000	0.15	(0.10—0.20)	750
6.3	50	2500	0.15	(0.10—0.20)	375	80	4000	0.17	(0.12—0.22)	680
8.0	50	1900	0.17	(0.12—0.22)	320	80	3100	0.19	(0.14—0.24)	585
10.0	40	1200	0.18	(0.13—0.23)	215	60	1900	0.20	(0.15—0.25)	380
12.0	40	1000	0.19	(0.14—0.24)	190	60	1500	0.21	(0.16—0.26)	315
16.0	40	700	0.20	(0.15—0.25)	140	60	1100	0.22	(0.17—0.27)	240
20.0	40	600	0.21	(0.16—0.26)	125	60	900	0.23	(0.18—0.28)	205

Обрабатываемый материал	M									
	Ферритная и мартенситная нержавеющая сталь ($>200\text{HB}$) X20CrNi17-2, X30Cr13					Закаленная нержавеющая сталь ($<450\text{HB}$) X5CrNiCuNb164, X7CrNiAl177, 17-4PH, 17-7PH				
Диам. сверла DC (мм)	Скорость резания (м/мин)	Частота вращения (мин ⁻¹)	Подача (мин.—макс.) (мм/об)		Подача (мм/мин)	Скорость резания (м/мин)	Частота вращения (мин ⁻¹)	Подача (мин.—макс.) (мм/об)		Подача (мм/мин)
3.2	60	5900	0.10	(0.05—0.15)	590	50	4900	0.10	(0.05—0.15)	490
4.0	60	4700	0.12	(0.08—0.18)	560	50	3900	0.12	(0.08—0.18)	465
5.0	60	3800	0.12	(0.08—0.18)	455	50	3100	0.12	(0.08—0.18)	370
6.3	60	3000	0.15	(0.10—0.20)	450	50	2500	0.15	(0.10—0.20)	375
8.0	60	2300	0.17	(0.12—0.22)	390	50	1900	0.17	(0.12—0.22)	320
10.0	50	1500	0.18	(0.13—0.23)	270	40	1200	0.18	(0.13—0.23)	215
12.0	50	1300	0.19	(0.14—0.24)	245	40	1000	0.19	(0.14—0.24)	190
16.0	50	900	0.20	(0.15—0.25)	180	40	700	0.20	(0.15—0.25)	140
20.0	50	700	0.21	(0.16—0.26)	145	40	600	0.21	(0.16—0.26)	125

Примечание 1) Для стабильного сверления рекомендуется подавать СОЖ под высоким давлением.

Примечание 2) В качестве охлаждающего средства рекомендуется эмульсия.

Примечание 3) При использовании водонерастворимой СОЖ рекомендуется снизить частоту вращения на 10—20%.

ТАБЛИЦА СРАВНЕНИЯ МАТЕРИАЛОВ ДЛЯ НЕРЖАВЕЮЩИХ СТАЛЕЙ

Обрабатываемый материал		Германия		США	Япония
		W-но.	DIN	AISI/SAE	JIS
Ферритная и мартенситная нержавеющая сталь	≤200HB	1.4005	X12CrS3	416	SUS416
		1.4006	X10Cr13	410	SUS410
		1.4016	X6Cr17	430	SUS430
		1.4113	X6CrMo17	434	SUS434
		1.4510	X6CrTi17	430Ti	SUS430LX
	>200HB	1.4512	X6CrTi12	409	—
		1.4021	X20Cr13	420	SUS420J1
		1.4057	X20CrNi17-2	431	SUS431
		1.4028	X30Cr13	420	SUS420J2
Нержавеющая сталь PH	<450HB	1.4125	X10CrMo17	440C	SUS440C
		1.4542	X5CrNiCuNb16 4	630 (17-4PH)	SUS630
		1.4545	—	S15500 (15-5PH)	—
Аустенитная нержавеющая сталь	≤200HB	1.4568	X7CrNiAl17 7	631 (17-7PH)	SUS631
		1.4301	X5CrNi18 10	304	SUS304
		1.4303	X5CrNi8-12	305	SUS305
		1.4305	X12CrNiS18-9	303	SUS303
		1.4307	X2CrNi19-11	304L	SUS304L
	>200HB	1.4401	X5CrNiMo17 12 2	316	SUS316
		1.4311	X2CrNiN18 10	304LN	SUS304LN
		1.4404	X2CrNiMo17 12 2	316L	SUS316L
		1.4406	X2CrNiMoN17 12 2	316LN	SUS316LN
		1.4435	X2CrNiMo18 14 3	—	SUS316L
		1.4438	X2CrNiMo18 15 4	317L	SUS317L
		1.4529	X1NiCrMoCuN25 20 7	N08926	—
		1.4541	X6CrNiTi18-10	321	SUS321
		1.4550	X6CrNiNb18-10	347	SUS347
		1.4571	X6CrNiMoTi17 12 2	316Ti	SUS316Ti
Дуплексная сталь	≤280HB	1.4362	X2CrNiN23 4	—	—
		1.4410	X2CrNiMoN25 7 4	S32750	SCS14A
		1.4460	X3CrNiMoN27 5 2	329	SUS329J1
		1.4462	X2CrNiMoN22 5 3	S31803	SUS329J3L

ИНСТРУМЕНТ ДЛЯ СВЕРЛЕНИЯ (МОНОЛИТНЫЕ ТВЕРДОСПЛАВНЫЕ СВЕРЛА)

ТВЕРДЫЙ СПЛАВ

DSAS NEW



P M K N **S** H

Внутреннее охлаждение



При осмотре покрытия цвет может варьироваться в зависимости от направления обзора. Это не оказывает никакого влияния на рабочие характеристики сверла.



DC=3	3<DC≤6	6<DC≤10	10<DC≤12
⁰ _{-0.018}	⁰ _{-0.018}	⁰ _{-0.022}	⁰ _{-0.027}
DCON=6	6<DCON≤10	DCON=12	
⁰ _{-0.018}	⁰ _{-0.009}	⁰ _{-0.011}	

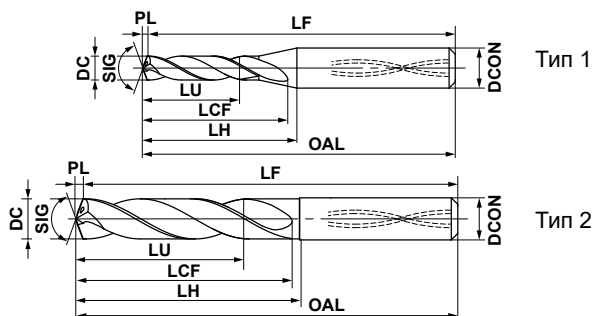

ИНСТРУМЕНТ ДЛЯ СВЕРЛЕНИЯ

M

DC (мм)	Глубина сверления (L/D)	DP9020	Обозначение	Размеры (мм)							Тип
				LU	LCF	LH	OAL	LF	PL	DCON	
3.00	3	●	DSAS0300X03S060	9.5	21.5	23.5	70.5	70	0.5	6	1
3.10	3	●	DSAS0310X03S060	9.9	21.6	23.6	70.6	70	0.6	6	1
3.18	3	●	DSAS0318X03S060	10.1	21.6	23.6	70.6	70	0.6	6	1
3.20	3	●	DSAS0320X03S060	10.2	21.6	23.6	70.6	70	0.6	6	1
3.26	3	●	DSAS0326X03S060	10.4	21.6	23.6	70.6	70	0.6	6	1
3.30	3	●	DSAS0330X03S060	10.5	21.6	23.6	70.6	70	0.6	6	1
3.40	3	●	DSAS0340X03S060	10.8	21.6	23.6	70.6	70	0.6	6	1
3.50	3	●	DSAS0350X03S060	11.1	21.6	23.6	70.6	70	0.6	6	1
3.57	3	●	DSAS0357X03S060	11.4	22.7	23.7	70.7	70	0.7	6	1
3.60	3	●	DSAS0360X03S060	11.5	22.7	23.7	70.7	70	0.7	6	1
3.70	3	●	DSAS0370X03S060	11.8	22.7	23.7	70.7	70	0.7	6	1
3.80	3	●	DSAS0380X03S060	12.1	22.7	23.7	70.7	70	0.7	6	1
3.90	3	●	DSAS0390X03S060	12.4	22.7	23.7	70.7	70	0.7	6	1
3.97	3	●	DSAS0397X03S060	12.6	22.7	23.7	70.7	70	0.7	6	1
4.00	3	●	DSAS0400X03S060	12.7	22.7	23.7	70.7	70	0.7	6	1
4.10	3	●	DSAS0410X03S060	13.0	24.7	26.7	73.7	73	0.7	6	1
4.20	3	●	DSAS0420X03S060	13.4	24.8	26.8	73.8	73	0.8	6	1
4.30	3	●	DSAS0430X03S060	13.7	24.8	26.8	73.8	73	0.8	6	1
4.37	3	●	DSAS0437X03S060	13.9	24.8	26.8	73.8	73	0.8	6	1
4.40	3	●	DSAS0440X03S060	14.0	24.8	26.8	73.8	73	0.8	6	1
4.50	3	●	DSAS0450X03S060	14.3	24.8	26.8	73.8	73	0.8	6	1
4.60	3	●	DSAS0460X03S060	14.6	25.8	28.8	75.8	75	0.8	6	1
4.70	3	●	DSAS0470X03S060	15.0	25.9	28.9	75.9	75	0.9	6	1
4.76	3	●	DSAS0476X03S060	15.2	25.9	28.9	75.9	75	0.9	6	1
4.80	3	●	DSAS0480X03S060	15.3	25.9	28.9	75.9	75	0.9	6	1
4.86	3	●	DSAS0486X03S060	15.5	25.9	28.9	75.9	75	0.9	6	1
4.90	3	●	DSAS0490X03S060	15.6	25.9	28.9	75.9	75	0.9	6	1
5.00	3	●	DSAS0500X03S060	15.9	28.9	29.9	81.9	81	0.9	6	2
5.10	3	●	DSAS0510X03S060	16.2	28.9	29.9	81.9	81	0.9	6	2
5.16	3	●	DSAS0516X03S060	16.5	29.0	30.0	82.0	81	1.0	6	2
5.20	3	●	DSAS0520X03S060	16.6	29.0	30.0	82.0	81	1.0	6	2
5.30	3	●	DSAS0530X03S060	16.9	29.0	30.0	82.0	81	1.0	6	2

Примечание: 1) Сквозные отверстия для подвода СОЖ у сверл с Ø5 мм или менее являются круглыми.

● : Есть на складе.

M096

DC (мм)	Глубина сверления (L/D)	DP9020	Обозначение	Размеры (мм)							Тип
				LU	LCF	LH	OAL	LF	PL	DCON	
5.40	3	●	DSAS0540X03S060	17.2	29.0	30.0	82.0	81	1.0	6	2
5.50	3	●	DSAS0550X03S060	17.5	29.0	30.0	82.0	81	1.0	6	2
5.56	3	●	DSAS0556X03S060	17.8	31.1	31.1	82.1	81	1.1	6	2
5.60	3	●	DSAS0560X03S060	17.9	31.1	31.1	82.1	81	1.1	6	2
5.70	3	●	DSAS0570X03S060	18.2	31.1	31.1	82.1	81	1.1	6	2
5.80	3	●	DSAS0580X03S060	18.5	31.1	31.1	82.1	81	1.1	6	2
5.90	3	●	DSAS0590X03S060	18.8	31.1	31.1	82.1	81	1.1	6	2
5.95	3	●	DSAS0595X03S060	19.0	31.1	31.1	82.1	81	1.1	6	2
6.00	3	●	DSAS0600X03S060	19.1	31.1	31.1	82.1	81	1.1	6	2
6.10	3	●	DSAS0610X03S080	19.5	34.2	37.2	87.2	86	1.2	8	2
6.20	3	●	DSAS0620X03S080	19.8	34.2	37.2	87.2	86	1.2	8	2
6.30	3	●	DSAS0630X03S080	20.1	34.2	37.2	87.2	86	1.2	8	2
6.35	3	●	DSAS0635X03S080	20.3	34.2	37.2	87.2	86	1.2	8	2
6.40	3	●	DSAS0640X03S080	20.4	34.2	37.2	87.2	86	1.2	8	2
6.50	3	●	DSAS0650X03S080	20.7	34.2	37.2	87.2	86	1.2	8	2
6.60	3	●	DSAS0660X03S080	21.1	36.3	38.3	91.3	90	1.3	8	2
6.70	3	●	DSAS0670X03S080	21.4	36.3	38.3	91.3	90	1.3	8	2
6.75	3	●	DSAS0675X03S080	21.6	36.3	38.3	91.3	90	1.3	8	2
6.80	3	●	DSAS0680X03S080	21.7	36.3	38.3	91.3	90	1.3	8	2
6.90	3	●	DSAS0690X03S080	22.0	36.3	38.3	91.3	90	1.3	8	2
6.95	3	●	DSAS0695X03S080	22.2	36.3	38.3	91.3	90	1.3	8	2
7.00	3	●	DSAS0700X03S080	22.3	36.3	38.3	91.3	90	1.3	8	2
7.10	3	●	DSAS0710X03S080	22.7	39.4	40.4	91.4	90	1.4	8	2
7.14	3	●	DSAS0714X03S080	22.8	39.4	40.4	91.4	90	1.4	8	2
7.20	3	●	DSAS0720X03S080	23.0	39.4	40.4	91.4	90	1.4	8	2
7.30	3	●	DSAS0730X03S080	23.3	39.4	40.4	91.4	90	1.4	8	2
7.40	3	●	DSAS0740X03S080	23.6	39.4	40.4	91.4	90	1.4	8	2
7.50	3	●	DSAS0750X03S080	23.9	39.4	40.4	91.4	90	1.4	8	2
7.54	3	●	DSAS0754X03S080	24.0	41.5	41.5	91.5	90	1.5	8	2
7.60	3	●	DSAS0760X03S080	24.3	41.5	41.5	91.5	90	1.5	8	2
7.70	3	●	DSAS0770X03S080	24.6	41.5	41.5	91.5	90	1.5	8	2
7.80	3	●	DSAS0780X03S080	24.9	41.5	41.5	91.5	90	1.5	8	2
7.90	3	●	DSAS0790X03S080	25.2	41.5	41.5	91.5	90	1.5	8	2
7.94	3	●	DSAS0794X03S080	25.3	41.5	41.5	91.5	90	1.5	8	2
8.00	3	●	DSAS0800X03S080	25.5	41.5	41.5	91.5	90	1.5	8	2
8.10	3	●	DSAS0810X03S100	25.8	44.5	47.5	97.5	96	1.5	10	2
8.20	3	●	DSAS0820X03S100	26.1	44.5	47.5	97.5	96	1.5	10	2
8.30	3	●	DSAS0830X03S100	26.4	44.5	47.5	97.5	96	1.5	10	2
8.33	3	●	DSAS0833X03S100	26.5	44.5	47.5	97.5	96	1.5	10	2
8.40	3	●	DSAS0840X03S100	26.7	44.5	47.5	97.5	96	1.5	10	2
8.50	3	●	DSAS0850X03S100	27.0	44.5	47.5	97.5	96	1.5	10	2
8.60	3	●	DSAS0860X03S100	27.4	46.6	48.6	102.6	101	1.6	10	2
8.70	3	●	DSAS0870X03S100	27.7	46.6	48.6	102.6	101	1.6	10	2
8.73	3	●	DSAS0873X03S100	27.8	46.6	48.6	102.6	101	1.6	10	2
8.80	3	●	DSAS0880X03S100	28.0	46.6	48.6	102.6	101	1.6	10	2
8.90	3	●	DSAS0890X03S100	28.3	46.6	48.6	102.6	101	1.6	10	2
9.00	3	●	DSAS0900X03S100	28.6	46.6	48.6	102.6	101	1.6	10	2
9.10	3	●	DSAS0910X03S100	29.1	49.8	50.8	102.8	101	1.8	10	2
9.20	3	●	DSAS0920X03S100	29.4	49.8	50.8	102.8	101	1.8	10	2
9.30	3	●	DSAS0930X03S100	29.7	49.8	50.8	102.8	101	1.8	10	2
9.40	3	●	DSAS0940X03S100	30.0	49.8	50.8	102.8	101	1.8	10	2
9.50	3	●	DSAS0950X03S100	30.3	49.8	50.8	102.8	101	1.8	10	2
9.53	3	●	DSAS0953X03S100	30.4	49.8	50.8	102.8	101	1.8	10	2
9.60	3	●	DSAS0960X03S100	30.6	49.8	50.8	102.8	101	1.8	10	2
9.70	3	●	DSAS0970X03S100	30.9	49.8	50.8	102.8	101	1.8	10	2
9.80	3	●	DSAS0980X03S100	31.2	51.8	51.8	102.8	101	1.8	10	2
9.90	3	●	DSAS0990X03S100	31.5	51.8	51.8	102.8	101	1.8	10	2
9.92	3	●	DSAS0992X03S100	31.6	51.8	51.8	102.8	101	1.8	10	2

ИНСТРУМЕНТ ДЛЯ СВЕРЛЕНИЯ (МОНОЛИТНЫЕ ТВЕРДОСПЛАВНЫЕ СВЕРЛА)

ТВЕРДЫЙ
СПЛАВ

DSAS NEW

ИНСТРУМЕНТ ДЛЯ
СВЕРЛЕНИЯ

M

DC (мм)	Глубина сверления (L/D)	DP9020	Обозначение	Размеры (мм)							Тип
				LU	LCF	LH	OAL	LF	PL	DCON	
10.00	3	●	DSAS1000X03S100	31.8	51.8	51.8	102.8	101	1.8	10	2
10.10	3	●	DSAS1010X03S120	32.2	54.9	57.9	112.9	111	1.9	12	2
10.20	3	●	DSAS1020X03S120	32.5	54.9	57.9	112.9	111	1.9	12	2
10.30	3	●	DSAS1030X03S120	32.8	54.9	57.9	112.9	111	1.9	12	2
10.32	3	●	DSAS1032X03S120	32.9	54.9	57.9	112.9	111	1.9	12	2
10.40	3	●	DSAS1040X03S120	33.1	54.9	57.9	112.9	111	1.9	12	2
10.50	3	●	DSAS1050X03S120	33.4	54.9	57.9	112.9	111	1.9	12	2
10.60	3	●	DSAS1060X03S120	33.7	54.9	57.9	112.9	111	1.9	12	2
10.70	3	●	DSAS1070X03S120	34.0	54.9	57.9	112.9	111	1.9	12	2
10.72	3	●	DSAS1072X03S120	34.2	57.0	59.0	118.0	116	2.0	12	2
10.80	3	●	DSAS1080X03S120	34.4	57.0	59.0	118.0	116	2.0	12	2
10.90	3	●	DSAS1090X03S120	34.7	57.0	59.0	118.0	116	2.0	12	2
11.00	3	●	DSAS1100X03S120	35.0	57.0	59.0	118.0	116	2.0	12	2
11.10	3	●	DSAS1110X03S120	35.4	60.1	61.1	118.1	116	2.1	12	2
11.11	3	●	DSAS1111X03S120	35.4	60.1	61.1	118.1	116	2.1	12	2
11.20	3	●	DSAS1120X03S120	35.7	60.1	61.1	118.1	116	2.1	12	2
11.30	3	●	DSAS1130X03S120	36.0	60.1	61.1	118.1	116	2.1	12	2
11.40	3	●	DSAS1140X03S120	36.3	60.1	61.1	118.1	116	2.1	12	2
11.50	3	●	DSAS1150X03S120	36.6	60.1	61.1	118.1	116	2.1	12	2
11.51	3	●	DSAS1151X03S120	36.7	62.2	62.2	118.2	116	2.2	12	2
11.60	3	●	DSAS1160X03S120	37.0	62.2	62.2	118.2	116	2.2	12	2
11.70	3	●	DSAS1170X03S120	37.3	62.2	62.2	118.2	116	2.2	12	2
11.80	3	●	DSAS1180X03S120	37.6	62.2	62.2	118.2	116	2.2	12	2
11.90	3	●	DSAS1190X03S120	37.9	62.2	62.2	118.2	116	2.2	12	2
12.00	3	●	DSAS1200X03S120	38.2	62.2	62.2	118.2	116	2.2	12	2

● : Есть на складе.

РЕКОМЕНДУЕМЫЕ РЕЖИМЫ РЕЗАНИЯ

Обрабатываемый материал		S			
		Жаропрочные сплавы Inconel718 и т. п.		Титановые сплавы Ti-6Al-4V и т. п.	
Диам. сверла DC (мм)	L/D	Частота вращения (мин ⁻¹)	Подача (мин. — макс.) (мм/об)	Частота вращения (мин ⁻¹)	Подача (мин. — макс.) (мм/об)
3	≤ 3	1000	0.06 (0.04—0.10)	4200	0.08 (0.06—0.12)
4	≤ 3	790	0.06 (0.04—0.10)	3100	0.10 (0.08—0.16)
5	≤ 3	760	0.08 (0.06—0.12)	2500	0.12 (0.08—0.20)
6	≤ 3	790	0.10 (0.08—0.15)	2100	0.14 (0.10—0.20)
8	≤ 3	590	0.10 (0.08—0.15)	1600	0.18 (0.15—0.25)
10	≤ 3	570	0.10 (0.08—0.15)	1300	0.22 (0.18—0.28)
12	≤ 3	530	0.12 (0.08—0.15)	1100	0.24 (0.20—0.30)

Примечание: 1) Для стабильного сверления рекомендуется подача СОЖ через шпиндель под высоким давлением.

Примечание: 2) Рекомендуется использовать водорастворимую эмульсию в качестве СОЖ.

Примечание: 3) При использовании водонерастворимой СОЖ уменьшите скорость резания на 10–20 %.

Примечание: 4) При сверлении с использованием наружной системы подачи СОЖ рекомендуется выполнять сверление с выводом сверла / поэтапной подачей через каждый участок глубиной DC x 0,5 для обеспечения дробления стружки.

M

ИНСТРУМЕНТ ДЛЯ
СВЕРЛЕНИЯ

ИНСТРУМЕНТ ДЛЯ СВЕРЛЕНИЯ (МОНОЛИТНЫЕ ТВЕРДОСПЛАВНЫЕ СВЕРЛА)

MNS



ТВЕРДЫЙ СПЛАВ

- P M K **N** S H

Внутреннее охлаждение



	DC=3	3<DC≤6	6<DC≤10	10<DC≤18	18<DC≤20
DIN Тип	+0.016 +0.004	+0.016 +0.004	+0.021 +0.006	+0.025 +0.007	+0.029 +0.008
Прочее	0 -0.014	0 -0.018	0 -0.022	0 -0.027	0 -0.031
h6	0 -0.006	0 -0.008	0 -0.009	0 -0.011	0 -0.013

- Сверла диаметром 4,5 мм и менее имеют только 2 отверстия для подачи СОЖ.
- Сверла диаметром 4,6 мм и более имеют 4 отверстия для подачи СОЖ.

● Тип 1 MNS---DIN-C, MNS-C, MNS---LB, MNS---DB (Цилиндрический хвостовик)

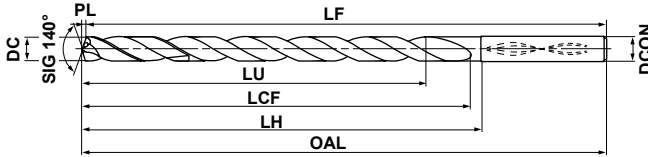

● Тип 2 MNS---S/L-DIN (Хвостовик с лыской)

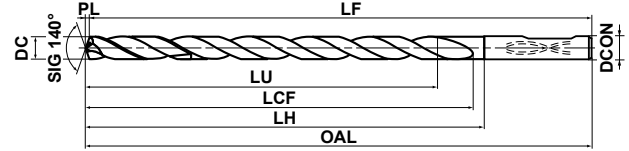

● Тип 3 MNS---DIN-C, MNS-C, MNS---LB, MNS---DB (Цилиндрический хвостовик)

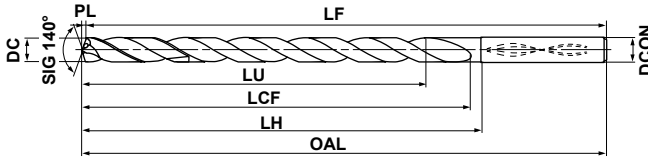

● Тип 4 MNS---S/L-DIN (Хвостовик с лыской)

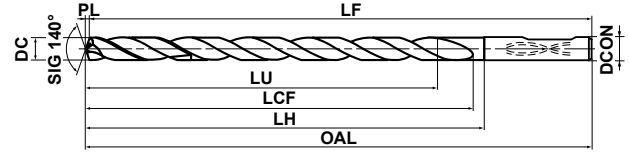

● Сверла MNS предназначены для использования с термопатронами.

DC (мм)	Глубина сверления (L/D)	TF15	Обозначение	Размеры (мм)								Тип
				LU	LCF	LH	OAL	LF	PL	DCON		
3.0	3	□	MNS0300S-DIN	15.0	19.5	24.5	61.5	61	0.5	6	2	
	3	□	MNS0300S-DIN-C	15.0	19.5	24.5	61.5	61	0.5	6	1	
	5	□	MNS0300L-DIN	23.0	27.5	28.5	65.5	65	0.5	6	2	
	5	●	MNS0300L-DIN-C	23.0	27.5	28.5	65.5	65	0.5	6	1	
	8	□	MNS0300-L8C	24.5	33.5	36.5	73.5	73	0.5	6	1	
	10	□	MNS0300-L10C	30.5	39.5	42.5	79.5	79	0.5	6	1	
	12	●	MNS0300-L12C	36.5	45.5	48.5	85.5	85	0.5	6	1	
	15	□	MNS0300-L15C	45.5	54.5	57.5	94.5	94	0.5	6	1	
	20	●	MNS0300-L20C	60.5	69.5	72.5	109.5	109	0.5	6	1	
	25	□	MNS0300-L25C	75.5	84.5	87.5	124.5	124	0.5	6	1	
	30	●	MNS0300-L30C	90.5	99.5	102.5	139.5	139	0.5	6	1	
	5	★	MNS0300LB	15.5	33.5	33.5	81.5	81	0.5	3	1	
10	★	MNS0300X10DB	30.5	39.5	42.5	90.5	90	0.5	3	1		
20	★	MNS0300X20DB	60.5	69.5	72.5	120.5	120	0.5	3	1		
30	★	MNS0300X30DB	90.5	99.5	102.5	150.5	150	0.5	3	1		
3.1	3	□	MNS0310S-DIN	14.9	19.6	24.6	61.6	61	0.6	6	2	
	3	□	MNS0310S-DIN-C	14.9	19.6	24.6	61.6	61	0.6	6	1	
	5	□	MNS0310L-DIN	22.9	27.6	28.6	65.6	65	0.6	6	2	
	5	□	MNS0310L-DIN-C	22.9	27.6	28.6	65.6	65	0.6	6	1	
	8	□	MNS0310-L8C	25.4	39.6	42.6	79.6	79	0.6	6	1	
	10	□	MNS0310-L10C	31.6	46.6	49.6	86.6	86	0.6	6	1	
	12	□	MNS0310-L12C	37.8	53.6	56.6	93.6	93	0.6	6	1	
	15	□	MNS0310-L15C	47.1	63.6	66.6	103.6	103	0.6	6	1	
	20	□	MNS0310-L20C	62.6	81.6	84.6	121.6	121	0.6	6	1	
	25	□	MNS0310-L25C	78.1	98.6	101.6	138.6	138	0.6	6	1	
	30	□	MNS0310-L30C	93.6	116.6	119.6	156.6	156	0.6	6	1	
	5	★	MNS0310LB	16.1	39.6	39.6	87.6	87	0.6	4	1	
10	□	MNS0310X10DB	31.6	46.6	49.6	97.6	97	0.6	4	1		
20	□	MNS0310X20DB	62.6	81.6	84.6	132.6	132	0.6	4	1		
30	□	MNS0310X30DB	93.6	116.6	119.6	167.6	167	0.6	4	1		

DC (мм)	Глубина сверления (L/D)	TF15	Обозначение	Размеры (мм)								Тип
				LU	LCF	LH	OAL	LF	PL	DCON		
3.2	3	□	MNS0320S-DIN	14.8	19.6	24.6	61.6	61	0.6	6	2	
	3	□	MNS0320S-DIN-C	14.8	19.6	24.6	61.6	61	0.6	6	1	
	5	□	MNS0320L-DIN	22.8	27.6	28.6	65.6	65	0.6	6	2	
	5	●	MNS0320L-DIN-C	22.8	27.6	28.6	65.6	65	0.6	6	1	
	8	□	MNS0320-L8C	26.2	39.6	42.6	79.6	79	0.6	6	1	
	10	□	MNS0320-L10C	32.6	46.6	49.6	86.6	86	0.6	6	1	
	12	●	MNS0320-L12C	39.0	53.6	56.6	93.6	93	0.6	6	1	
	15	□	MNS0320-L15C	48.6	63.6	66.6	103.6	103	0.6	6	1	
	20	●	MNS0320-L20C	64.6	81.6	84.6	121.6	121	0.6	6	1	
	25	□	MNS0320-L25C	80.6	98.6	101.6	138.6	138	0.6	6	1	
	30	●	MNS0320-L30C	96.6	116.6	119.6	156.6	156	0.6	6	1	
	5	★	MNS0320LB	16.6	39.6	39.6	87.6	87	0.6	4	1	
10	★	MNS0320X10DB	32.6	46.6	49.6	97.6	97	0.6	4	1		
20	★	MNS0320X20DB	64.6	81.6	84.6	132.6	132	0.6	4	1		
30	★	MNS0320X30DB	96.6	116.6	119.6	167.6	167	0.6	4	1		
3.3	3	□	MNS0330S-DIN	14.7	19.6	24.6	61.6	61	0.6	6	2	
	3	□	MNS0330S-DIN-C	14.7	19.6	24.6	61.6	61	0.6	6	1	
	5	□	MNS0330L-DIN	22.7	27.6	28.6	65.6	65	0.6	6	2	
	5	●	MNS0330L-DIN-C	22.7	27.6	28.6	65.6	65	0.6	6	1	
	8	□	MNS0330-L8C	27.0	39.6	42.6	79.6	79	0.6	6	1	
	10	□	MNS0330-L10C	33.6	46.6	49.6	86.6	86	0.6	6	1	
	12	●	MNS0330-L12C	40.2	53.6	56.6	93.6	93	0.6	6	1	
	15	□	MNS0330-L15C	50.1	63.6	66.6	103.6	103	0.6	6	1	
	20	●	MNS0330-L20C	66.6	81.6	84.6	121.6	121	0.6	6	1	
	25	□	MNS0330-L25C	83.1	98.6	101.6	138.6	138	0.6	6	1	
	30	●	MNS0330-L30C	99.6	116.6	119.6	156.6	156	0.6	6	1	
	5	★	MNS0330LB	17.1	39.6	39.6	87.6	87	0.6	4	1	
10	□	MNS0330X10DB	33.6	46.6	49.6	97.6	97	0.6	4	1		
20	□	MNS0330X20DB	66.6	81.6	84.6	132.6	132	0.6	4	1		
30	□	MNS0330X30DB	99.6	116.6	119.6	167.6	167	0.6	4	1		

Примечание 1) Пожалуйста, свяжитесь с нами если Вы не нашли нужную геометрию в данном каталоге (могут быть заказаны другие диаметры и длины).

● : Есть на складе. ★ : Со склада в Японии.

□ : Нет на складе, выпускается исключительно под заказ.

DC (мм)	Глубина сверления (L/D)	TF15	Обозначение	Размеры (мм)						Тип	
				LU	LCF	LH	OAL	LF	PL		DCON
3.4	3	□	MNS0340S-DIN	14.5	19.6	24.6	61.6	61	0.6	6	2
	3	□	MNS0340S-DIN-C	14.5	19.6	24.6	61.6	61	0.6	6	1
	5	□	MNS0340L-DIN	22.5	27.6	28.6	65.6	65	0.6	6	2
	5	□	MNS0340L-DIN-C	22.5	27.6	28.6	65.6	65	0.6	6	1
	8	□	MNS0340-L8C	27.8	39.6	42.6	79.6	79	0.6	6	1
	10	□	MNS0340-L10C	34.6	46.6	49.6	86.6	86	0.6	6	1
	12	□	MNS0340-L12C	41.4	53.6	56.6	93.6	93	0.6	6	1
	15	□	MNS0340-L15C	51.6	63.6	66.6	103.6	103	0.6	6	1
	20	□	MNS0340-L20C	68.6	81.6	84.6	121.6	121	0.6	6	1
	25	□	MNS0340-L25C	85.6	98.6	101.6	138.6	138	0.6	6	1
	30	□	MNS0340-L30C	102.6	116.6	119.6	156.6	156	0.6	6	1
	5	★	MNS0340LB	17.6	39.6	39.6	87.6	87	0.6	4	1
	10	★	MNS0340X10DB	34.6	46.6	49.6	97.6	97	0.6	4	1
	20	★	MNS0340X20DB	68.6	81.6	84.6	132.6	132	0.6	4	1
30	★	MNS0340X30DB	102.6	116.6	119.6	167.6	167	0.6	4	1	
3.5	3	□	MNS0350S-DIN	14.4	19.6	24.6	61.6	61	0.6	6	2
	3	□	MNS0350S-DIN-C	14.4	19.6	24.6	61.6	61	0.6	6	1
	5	□	MNS0350L-DIN	22.4	27.6	28.6	65.6	65	0.6	6	2
	5	●	MNS0350L-DIN-C	22.4	27.6	28.6	65.6	65	0.6	6	1
	8	□	MNS0350-L8C	28.6	39.6	42.6	79.6	79	0.6	6	1
	10	□	MNS0350-L10C	35.6	46.6	49.6	86.6	86	0.6	6	1
	12	●	MNS0350-L12C	42.6	53.6	56.6	93.6	93	0.6	6	1
	15	□	MNS0350-L15C	53.1	63.6	66.6	103.6	103	0.6	6	1
	20	●	MNS0350-L20C	70.6	81.6	84.6	121.6	121	0.6	6	1
	25	□	MNS0350-L25C	88.1	98.6	101.6	138.6	138	0.6	6	1
	30	●	MNS0350-L30C	105.6	116.6	119.6	156.6	156	0.6	6	1
	5	★	MNS0350LB	18.1	39.6	39.6	87.6	87	0.6	4	1
	10	□	MNS0350X10DB	35.6	46.6	49.6	97.6	97	0.6	4	1
	20	□	MNS0350X20DB	70.6	81.6	84.6	132.6	132	0.6	4	1
30	□	MNS0350X30DB	105.6	116.6	119.6	167.6	167	0.6	4	1	
3.6	3	□	MNS0360S-DIN	14.3	19.7	24.7	61.7	61	0.7	6	2
	3	□	MNS0360S-DIN-C	14.3	19.7	24.7	61.7	61	0.7	6	1
	5	□	MNS0360L-DIN	22.3	27.7	28.7	65.7	65	0.7	6	2
	5	□	MNS0360L-DIN-C	22.3	27.7	28.7	65.7	65	0.7	6	1
	8	□	MNS0360-L8C	29.5	44.7	47.7	84.7	84	0.7	6	1
	10	□	MNS0360-L10C	36.7	52.7	55.7	92.7	92	0.7	6	1
	12	□	MNS0360-L12C	43.9	60.7	63.7	100.7	100	0.7	6	1
	15	□	MNS0360-L15C	54.7	72.7	75.7	112.7	112	0.7	6	1
	20	□	MNS0360-L20C	72.7	92.7	95.7	132.7	132	0.7	6	1
	25	□	MNS0360-L25C	90.7	112.7	115.7	152.7	152	0.7	6	1
	30	□	MNS0360-L30C	108.7	132.7	135.7	172.7	172	0.7	6	1
	5	★	MNS0360LB	18.7	44.7	44.7	92.7	92	0.7	4	1
	10	★	MNS0360X10DB	36.7	52.7	55.7	103.7	103	0.7	4	1
	20	★	MNS0360X20DB	72.7	92.7	95.7	143.7	143	0.7	4	1
30	★	MNS0360X30DB	108.7	132.7	135.7	183.7	183	0.7	4	1	

DC (мм)	Глубина сверления (L/D)	TF15	Обозначение	Размеры (мм)						Тип	
				LU	LCF	LH	OAL	LF	PL		DCON
3.7	3	□	MNS0370S-DIN	14.1	19.7	24.7	61.7	61	0.7	6	2
	3	□	MNS0370S-DIN-C	14.1	19.7	24.7	61.7	61	0.7	6	1
	5	□	MNS0370L-DIN	22.1	27.7	28.7	65.7	65	0.7	6	2
	5	□	MNS0370L-DIN-C	22.1	27.7	28.7	65.7	65	0.7	6	1
	8	□	MNS0370-L8C	30.3	44.7	47.7	84.7	84	0.7	6	1
	10	□	MNS0370-L10C	37.7	52.7	55.7	92.7	92	0.7	6	1
	12	□	MNS0370-L12C	45.1	60.7	63.7	100.7	100	0.7	6	1
	15	□	MNS0370-L15C	56.2	72.7	75.7	112.7	112	0.7	6	1
	20	□	MNS0370-L20C	74.7	92.7	95.7	132.7	132	0.7	6	1
	25	□	MNS0370-L25C	93.2	112.7	115.7	152.7	152	0.7	6	1
	30	□	MNS0370-L30C	111.7	132.7	135.7	172.7	172	0.7	6	1
	5	★	MNS0370LB	19.2	44.7	44.7	92.7	92	0.7	4	1
	10	□	MNS0370X10DB	37.7	52.7	55.7	103.7	103	0.7	4	1
	20	□	MNS0370X20DB	74.7	92.7	95.7	143.7	143	0.7	4	1
30	□	MNS0370X30DB	111.7	132.7	135.7	183.7	183	0.7	4	1	
3.8	3	□	MNS0380S-DIN	18.0	23.7	28.7	65.7	65	0.7	6	2
	3	□	MNS0380S-DIN-C	18.0	23.7	28.7	65.7	65	0.7	6	1
	5	□	MNS0380L-DIN	30.0	35.7	36.7	73.7	73	0.7	6	2
	5	□	MNS0380L-DIN-C	30.0	35.7	36.7	73.7	73	0.7	6	1
	8	□	MNS0380-L8C	31.1	44.7	47.7	84.7	84	0.7	6	1
	10	□	MNS0380-L10C	38.7	52.7	55.7	92.7	92	0.7	6	1
	12	□	MNS0380-L12C	46.3	60.7	63.7	100.7	100	0.7	6	1
	15	□	MNS0380-L15C	57.7	72.7	75.7	112.7	112	0.7	6	1
	20	□	MNS0380-L20C	76.7	92.7	95.7	132.7	132	0.7	6	1
	25	□	MNS0380-L25C	95.7	112.7	115.7	152.7	152	0.7	6	1
	30	□	MNS0380-L30C	114.7	132.7	135.7	172.7	172	0.7	6	1
	5	★	MNS0380LB	19.7	44.7	44.7	92.7	92	0.7	4	1
	10	□	MNS0380X10DB	38.7	52.7	55.7	103.7	103	0.7	4	1
	20	□	MNS0380X20DB	76.7	92.7	95.7	143.7	143	0.7	4	1
30	□	MNS0380X30DB	114.7	132.7	135.7	183.7	183	0.7	4	1	
3.9	3	□	MNS0390S-DIN	17.9	23.7	28.7	65.7	65	0.7	6	2
	3	□	MNS0390S-DIN-C	17.9	23.7	28.7	65.7	65	0.7	6	1
	5	□	MNS0390L-DIN	29.9	35.7	36.7	73.7	73	0.7	6	2
	5	□	MNS0390L-DIN-C	29.9	35.7	36.7	73.7	73	0.7	6	1
	8	□	MNS0390-L8C	31.9	44.7	47.7	84.7	84	0.7	6	1
	10	□	MNS0390-L10C	39.7	52.7	55.7	92.7	92	0.7	6	1
	12	□	MNS0390-L12C	47.5	60.7	63.7	100.7	100	0.7	6	1
	15	□	MNS0390-L15C	59.2	72.7	75.7	112.7	112	0.7	6	1
	20	□	MNS0390-L20C	78.7	92.7	95.7	132.7	132	0.7	6	1
	25	□	MNS0390-L25C	98.2	112.7	115.7	152.7	152	0.7	6	1
	30	□	MNS0390-L30C	117.7	132.7	135.7	172.7	172	0.7	6	1
	5	★	MNS0390LB	20.2	44.7	44.7	92.7	92	0.7	4	1
	10	★	MNS0390X10DB	39.7	52.7	55.7	103.7	103	0.7	4	1
	20	★	MNS0390X20DB	78.7	92.7	95.7	143.7	143	0.7	4	1
30	★	MNS0390X30DB	117.7	132.7	135.7	183.7	183	0.7	4	1	

М
ИНСТРУМЕНТ ДЛЯ
СВЕРЛЕНИЯ

DC (мм)	Глубина сверления (L/D)	TF15	Обозначение	Размеры (мм)							Тип
				LU	LCF	LH	OAL	LF	PL	DCON	
4.0	3	<input type="checkbox"/>	MNS0400S-DIN	17.7	23.7	28.7	65.7	65	0.7	6	2
	3	<input type="checkbox"/>	MNS0400S-DIN-C	17.7	23.7	28.7	65.7	65	0.7	6	1
	5	<input type="checkbox"/>	MNS0400L-DIN	29.7	35.7	36.7	73.7	73	0.7	6	2
	5	<input checked="" type="checkbox"/>	MNS0400L-DIN-C	29.7	35.7	36.7	73.7	73	0.7	6	1
	8	<input type="checkbox"/>	MNS0400-L8C	32.7	44.7	47.7	84.7	84	0.7	6	1
	10	<input type="checkbox"/>	MNS0400-L10C	40.7	52.7	55.7	92.7	92	0.7	6	1
	12	<input checked="" type="checkbox"/>	MNS0400-L12C	48.7	60.7	63.7	100.7	100	0.7	6	1
	15	<input type="checkbox"/>	MNS0400-L15C	60.7	72.7	75.7	112.7	112	0.7	6	1
	20	<input checked="" type="checkbox"/>	MNS0400-L20C	80.7	92.7	95.7	132.7	132	0.7	6	1
	25	<input checked="" type="checkbox"/>	MNS0400-L25C	100.7	112.7	115.7	152.7	152	0.7	6	1
	30	<input checked="" type="checkbox"/>	MNS0400-L30C	120.7	132.7	135.7	172.7	172	0.7	6	1
	5	<input checked="" type="checkbox"/>	MNS0400LB	20.7	44.7	44.7	92.7	92	0.7	4	1
	10	<input checked="" type="checkbox"/>	MNS0400X10DB	40.7	52.7	55.7	103.7	103	0.7	4	1
20	<input checked="" type="checkbox"/>	MNS0400X20DB	80.7	92.7	95.7	143.7	143	0.7	4	1	
30	<input checked="" type="checkbox"/>	MNS0400X30DB	120.7	132.7	135.7	183.7	183	0.7	4	1	
4.1	3	<input type="checkbox"/>	MNS0410S-DIN	17.6	23.7	28.7	65.7	65	0.7	6	2
	3	<input type="checkbox"/>	MNS0410S-DIN-C	17.6	23.7	28.7	65.7	65	0.7	6	1
	5	<input type="checkbox"/>	MNS0410L-DIN	29.6	35.7	36.7	73.7	73	0.7	6	2
	5	<input type="checkbox"/>	MNS0410L-DIN-C	29.6	35.7	36.7	73.7	73	0.7	6	1
	8	<input type="checkbox"/>	MNS0410-L8C	33.5	50.7	53.7	90.7	90	0.7	6	1
	10	<input type="checkbox"/>	MNS0410-L10C	41.7	59.7	62.7	99.7	99	0.7	6	1
	12	<input type="checkbox"/>	MNS0410-L12C	49.9	68.7	71.7	108.7	108	0.7	6	1
	15	<input type="checkbox"/>	MNS0410-L15C	62.2	81.7	84.7	121.7	121	0.7	6	1
	20	<input type="checkbox"/>	MNS0410-L20C	82.7	104.7	107.7	144.7	144	0.7	6	1
	25	<input type="checkbox"/>	MNS0410-L25C	103.2	126.7	129.7	166.7	166	0.7	6	1
	30	<input type="checkbox"/>	MNS0410-L30C	123.7	149.7	152.7	189.7	189	0.7	6	1
	5	<input checked="" type="checkbox"/>	MNS0410LB	21.2	50.7	50.7	100.7	100	0.7	5	1
	10	<input type="checkbox"/>	MNS0410X10DB	41.7	59.7	62.7	112.7	112	0.7	5	1
20	<input type="checkbox"/>	MNS0410X20DB	82.7	104.7	107.7	157.7	157	0.7	5	1	
30	<input type="checkbox"/>	MNS0410X30DB	123.7	149.7	152.7	202.7	202	0.7	5	1	
4.2	3	<input type="checkbox"/>	MNS0420S-DIN	17.5	23.8	28.8	65.8	65	0.8	6	2
	3	<input type="checkbox"/>	MNS0420S-DIN-C	17.5	23.8	28.8	65.8	65	0.8	6	1
	5	<input type="checkbox"/>	MNS0420L-DIN	29.5	35.8	36.8	73.8	73	0.8	6	2
	5	<input checked="" type="checkbox"/>	MNS0420L-DIN-C	29.5	35.8	36.8	73.8	73	0.8	6	1
	8	<input type="checkbox"/>	MNS0420-L8C	34.4	50.8	53.8	90.8	90	0.8	6	1
	10	<input type="checkbox"/>	MNS0420-L10C	42.8	59.8	62.8	99.8	99	0.8	6	1
	12	<input checked="" type="checkbox"/>	MNS0420-L12C	51.2	68.8	71.8	108.8	108	0.8	6	1
	15	<input type="checkbox"/>	MNS0420-L15C	63.8	81.8	84.8	121.8	121	0.8	6	1
	20	<input checked="" type="checkbox"/>	MNS0420-L20C	84.8	104.8	107.8	144.8	144	0.8	6	1
	25	<input type="checkbox"/>	MNS0420-L25C	105.8	126.8	129.8	166.8	166	0.8	6	1
	30	<input checked="" type="checkbox"/>	MNS0420-L30C	126.8	149.8	152.8	189.8	189	0.8	6	1
	5	<input checked="" type="checkbox"/>	MNS0420LB	21.8	50.8	50.8	100.8	100	0.8	5	1
	10	<input type="checkbox"/>	MNS0420X10DB	42.8	59.8	62.8	112.8	112	0.8	5	1
20	<input type="checkbox"/>	MNS0420X20DB	84.8	104.8	107.8	157.8	157	0.8	5	1	
30	<input type="checkbox"/>	MNS0420X30DB	126.8	149.8	152.8	202.8	202	0.8	5	1	

DC (мм)	Глубина сверления (L/D)	TF15	Обозначение	Размеры (мм)							Тип
				LU	LCF	LH	OAL	LF	PL	DCON	
4.3	3	<input type="checkbox"/>	MNS0430S-DIN	17.3	23.8	28.8	65.8	65	0.8	6	2
	3	<input type="checkbox"/>	MNS0430S-DIN-C	17.3	23.8	28.8	65.8	65	0.8	6	1
	5	<input type="checkbox"/>	MNS0430L-DIN	29.3	35.8	36.8	73.8	73	0.8	6	2
	5	<input type="checkbox"/>	MNS0430L-DIN-C	29.3	35.8	36.8	73.8	73	0.8	6	1
	8	<input type="checkbox"/>	MNS0430-L8C	35.2	50.8	53.8	90.8	90	0.8	6	1
	10	<input type="checkbox"/>	MNS0430-L10C	43.8	59.8	62.8	99.8	99	0.8	6	1
	12	<input type="checkbox"/>	MNS0430-L12C	52.4	68.8	71.8	108.8	108	0.8	6	1
	15	<input type="checkbox"/>	MNS0430-L15C	65.3	81.8	84.8	121.8	121	0.8	6	1
	20	<input type="checkbox"/>	MNS0430-L20C	86.8	104.8	107.8	144.8	144	0.8	6	1
	25	<input type="checkbox"/>	MNS0430-L25C	108.3	126.8	129.8	166.8	166	0.8	6	1
	30	<input type="checkbox"/>	MNS0430-L30C	129.8	149.8	152.8	189.8	189	0.8	6	1
	5	<input checked="" type="checkbox"/>	MNS0430LB	22.3	50.8	50.8	100.8	100	0.8	5	1
	10	<input type="checkbox"/>	MNS0430X10DB	43.8	59.8	62.8	112.8	112	0.8	5	1
20	<input type="checkbox"/>	MNS0430X20DB	86.8	104.8	107.8	157.8	157	0.8	5	1	
30	<input type="checkbox"/>	MNS0430X30DB	129.8	149.8	152.8	202.8	202	0.8	5	1	
4.4	3	<input type="checkbox"/>	MNS0440S-DIN	17.2	23.8	28.8	65.8	65	0.8	6	2
	3	<input type="checkbox"/>	MNS0440S-DIN-C	17.2	23.8	28.8	65.8	65	0.8	6	1
	5	<input type="checkbox"/>	MNS0440L-DIN	29.2	35.8	36.8	73.8	73	0.8	6	2
	5	<input type="checkbox"/>	MNS0440L-DIN-C	29.2	35.8	36.8	73.8	73	0.8	6	1
	8	<input type="checkbox"/>	MNS0440-L8C	36.0	50.8	53.8	90.8	90	0.8	6	1
	10	<input type="checkbox"/>	MNS0440-L10C	44.8	59.8	62.8	99.8	99	0.8	6	1
	12	<input type="checkbox"/>	MNS0440-L12C	53.6	68.8	71.8	108.8	108	0.8	6	1
	15	<input type="checkbox"/>	MNS0440-L15C	66.8	81.8	84.8	121.8	121	0.8	6	1
	20	<input type="checkbox"/>	MNS0440-L20C	88.8	104.8	107.8	144.8	144	0.8	6	1
	25	<input type="checkbox"/>	MNS0440-L25C	110.8	126.8	129.8	166.8	166	0.8	6	1
	30	<input type="checkbox"/>	MNS0440-L30C	132.8	149.8	152.8	189.8	189	0.8	6	1
	5	<input checked="" type="checkbox"/>	MNS0440LB	22.8	50.8	50.8	100.8	100	0.8	5	1
	10	<input type="checkbox"/>	MNS0440X10DB	44.8	59.8	62.8	112.8	112	0.8	5	1
20	<input type="checkbox"/>	MNS0440X20DB	88.8	104.8	107.8	157.8	157	0.8	5	1	
30	<input type="checkbox"/>	MNS0440X30DB	132.8	149.8	152.8	202.8	202	0.8	5	1	
4.5	3	<input type="checkbox"/>	MNS0450S-DIN	17.1	23.8	28.8	65.8	65	0.8	6	2
	3	<input type="checkbox"/>	MNS0450S-DIN-C	17.1	23.8	28.8	65.8	65	0.8	6	1
	5	<input type="checkbox"/>	MNS0450L-DIN	29.1	35.8	36.8	73.8	73	0.8	6	2
	5	<input checked="" type="checkbox"/>	MNS0450L-DIN-C	29.1	35.8	36.8	73.8	73	0.8	6	1
	8	<input type="checkbox"/>	MNS0450-L8C	36.8	50.8	53.8	90.8	90	0.8	6	1
	10	<input type="checkbox"/>	MNS0450-L10C	45.8	59.8	62.8	99.8	99	0.8	6	1
	12	<input checked="" type="checkbox"/>	MNS0450-L12C	54.8	68.8	71.8	108.8	108	0.8	6	1
	15	<input type="checkbox"/>	MNS0450-L15C	68.3	81.8	84.8	121.8	121	0.8	6	1
	20	<input checked="" type="checkbox"/>	MNS0450-L20C	90.8	104.8	107.8	144.8	144	0.8	6	1
	25	<input type="checkbox"/>	MNS0450-L25C	113.3	126.8	129.8	166.8	166	0.8	6	1
	30	<input checked="" type="checkbox"/>	MNS0450-L30C	135.8	149.8	152.8	189.8	189	0.8	6	1
	5	<input checked="" type="checkbox"/>	MNS0450LB	23.3	50.8	50.8	100.8	100	0.8	5	1
	10	<input type="checkbox"/>	MNS0450X10DB	45.8	59.8	62.8	112.8	112	0.8	5	1
20	<input type="checkbox"/>	MNS0450X20DB	90.8	104.8	107.8	157.8	157	0.8	5	1	
30	<input type="checkbox"/>	MNS0450X30DB	135.8	149.8	152.8	202.8	202	0.8	5	1	

Примечание 1) Пожалуйста, свяжитесь с нами если Вы не нашли нужную геометрию в данном каталоге (могут быть заказаны другие диаметры и длины).

● : Есть на складе. ★ : Со склада в Японии.

□ : Нет на складе, выпускается исключительно под заказ.

DC (мм)	Глубина сверления (L/D)	TF15	Обозначение	Размеры (мм)							Тип
				LU	LCF	LH	OAL	LF	PL	DCON	
4.6	3	□	MNS0460S-DIN	17.1	23.8	28.8	65.8	65	0.8	6	4
	3	□	MNS0460S-DIN-C	16.9	23.8	28.8	65.8	65	0.8	6	3
	5	□	MNS0460L-DIN	28.9	35.8	36.8	73.8	73	0.8	6	4
	5	□	MNS0460L-DIN-C	28.9	35.8	36.8	73.8	73	0.8	6	3
	8	□	MNS0460-L8C	37.6	55.8	58.8	95.8	95	0.8	6	3
	10	□	MNS0460-L10C	46.8	65.8	68.8	105.8	105	0.8	6	3
	12	□	MNS0460-L12C	56.0	75.8	78.8	115.8	115	0.8	6	3
	15	□	MNS0460-L15C	69.8	90.8	93.8	130.8	130	0.8	6	3
	20	□	MNS0460-L20C	92.8	115.8	118.8	155.8	155	0.8	6	3
	25	□	MNS0460-L25C	115.8	140.8	143.8	180.8	180	0.8	6	3
	30	□	MNS0460-L30C	138.8	165.8	168.8	205.8	205	0.8	6	3
	5	★	MNS0460LB	23.8	55.8	55.8	105.8	105	0.8	5	3
	10	□	MNS0460X10DB	46.8	65.8	68.8	118.8	118	0.8	5	3
	20	□	MNS0460X20DB	92.8	115.8	118.8	168.8	168	0.8	5	3
30	□	MNS0460X30DB	138.8	165.8	168.8	218.8	218	0.8	5	3	
4.65	3	□	MNS0465S-DIN	16.9	23.8	28.8	65.8	65	0.8	6	4
	3	□	MNS0465S-DIN-C	16.9	23.8	28.8	65.8	65	0.8	6	3
	5	□	MNS0465L-DIN	28.9	35.8	36.8	73.8	73	0.8	6	4
	5	●	MNS0465L-DIN-C	28.9	35.8	36.8	73.8	73	0.8	6	3
4.7	3	□	MNS0470S-DIN	16.8	23.9	28.9	65.9	65	0.9	6	4
	3	□	MNS0470S-DIN-C	16.8	23.9	28.9	65.9	65	0.9	6	3
	5	□	MNS0470L-DIN	28.8	35.9	36.9	73.9	73	0.9	6	4
	5	□	MNS0470L-DIN-C	28.8	35.9	36.9	73.9	73	0.9	6	3
	8	□	MNS0470-L8C	38.5	55.9	58.9	95.9	95	0.9	6	3
	10	□	MNS0470-L10C	47.9	65.9	68.9	105.9	105	0.9	6	3
	12	□	MNS0470-L12C	57.3	75.9	78.9	115.9	115	0.9	6	3
	15	□	MNS0470-L15C	71.4	90.9	93.9	130.9	130	0.9	6	3
	20	□	MNS0470-L20C	94.9	115.9	118.9	155.9	155	0.9	6	3
	25	□	MNS0470-L25C	118.4	140.9	143.9	180.9	180	0.9	6	3
	30	□	MNS0470-L30C	141.9	165.9	168.9	205.9	205	0.9	6	3
	5	★	MNS0470LB	24.4	55.9	55.9	105.9	105	0.9	5	3
	10	□	MNS0470X10DB	47.9	65.9	68.9	118.9	118	0.9	5	3
	20	□	MNS0470X20DB	94.9	115.9	118.9	168.9	168	0.9	5	3
30	□	MNS0470X30DB	141.9	165.9	168.9	218.9	218	0.9	5	3	
4.8	3	□	MNS0480S-DIN	20.7	27.9	28.9	65.9	65	0.9	6	4
	3	□	MNS0480S-DIN-C	20.7	27.9	28.9	65.9	65	0.9	6	3
	5	□	MNS0480L-DIN	36.7	43.9	44.9	81.9	81	0.9	6	4
	5	□	MNS0480L-DIN-C	36.7	43.9	44.9	81.9	81	0.9	6	3
	8	□	MNS0480-L8C	39.3	55.9	58.9	95.9	95	0.9	6	3
	10	□	MNS0480-L10C	48.9	65.9	68.9	105.9	105	0.9	6	3
	12	□	MNS0480-L12C	58.5	75.9	78.9	115.9	115	0.9	6	3
	15	□	MNS0480-L15C	72.9	90.9	93.9	130.9	130	0.9	6	3
	20	□	MNS0480-L20C	96.9	115.9	118.9	155.9	155	0.9	6	3
	25	□	MNS0480-L25C	120.9	140.9	143.9	180.9	180	0.9	6	3
	30	□	MNS0480-L30C	144.9	165.9	168.9	205.9	205	0.9	6	3
	5	★	MNS0480LB	24.9	55.9	55.9	105.9	105	0.9	5	3
	10	□	MNS0480X10DB	48.9	65.9	68.9	118.9	118	0.9	5	3
	20	□	MNS0480X20DB	96.9	115.9	118.9	168.9	168	0.9	5	3
30	□	MNS0480X30DB	144.9	165.9	168.9	218.9	218	0.9	5	3	

DC (мм)	Глубина сверления (L/D)	TF15	Обозначение	Размеры (мм)							Тип
				LU	LCF	LH	OAL	LF	PL	DCON	
4.9	3	□	MNS0490S-DIN	20.5	27.9	28.9	65.9	65	0.9	6	4
	3	□	MNS0490S-DIN-C	20.5	27.9	28.9	65.9	65	0.9	6	3
	5	□	MNS0490L-DIN	36.5	43.9	44.9	81.9	81	0.9	6	4
	5	□	MNS0490L-DIN-C	36.5	43.9	44.9	81.9	81	0.9	6	3
	8	□	MNS0490-L8C	40.1	55.9	58.9	95.9	95	0.9	6	3
	10	□	MNS0490-L10C	49.9	65.9	68.9	105.9	105	0.9	6	3
	12	□	MNS0490-L12C	59.7	75.9	78.9	115.9	115	0.9	6	3
	15	□	MNS0490-L15C	74.4	90.9	93.9	130.9	130	0.9	6	3
	20	□	MNS0490-L20C	98.9	115.9	118.9	155.9	155	0.9	6	3
	25	□	MNS0490-L25C	123.4	140.9	143.9	180.9	180	0.9	6	3
	30	□	MNS0490-L30C	147.9	165.9	168.9	205.9	205	0.9	6	3
	5	★	MNS0490LB	25.4	55.9	55.9	105.9	105	0.9	5	3
	10	★	MNS0490X10DB	49.9	65.9	68.9	118.9	118	0.9	5	3
	20	★	MNS0490X20DB	98.9	115.9	118.9	168.9	168	0.9	5	3
30	★	MNS0490X30DB	147.9	165.9	168.9	218.9	218	0.9	5	3	
5.0	3	□	MNS0500S-DIN	20.4	27.9	28.9	65.9	65	0.9	6	4
	3	□	MNS0500S-DIN-C	20.4	27.9	28.9	65.9	65	0.9	6	3
	5	□	MNS0500L-DIN	36.4	43.9	44.9	81.9	81	0.9	6	4
	5	●	MNS0500L-DIN-C	36.4	43.9	44.9	81.9	81	0.9	6	3
	8	□	MNS0500-L8C	40.9	55.9	58.9	95.9	95	0.9	6	3
	10	□	MNS0500-L10C	50.9	65.9	68.9	105.9	105	0.9	6	3
	12	●	MNS0500-L12C	60.9	75.9	78.9	115.9	115	0.9	6	3
	15	□	MNS0500-L15C	75.9	90.9	93.9	130.9	130	0.9	6	3
	20	●	MNS0500-L20C	100.9	115.9	118.9	155.9	155	0.9	6	3
	25	□	MNS0500-L25C	125.9	140.9	143.9	180.9	180	0.9	6	3
	30	●	MNS0500-L30C	150.9	165.9	168.9	205.9	205	0.9	6	3
	5	★	MNS0500LB	25.9	44.9	44.9	100.9	100	0.9	6	3
	10	★	MNS0500X10DB	50.9	65.9	68.9	118.9	118	0.9	5	3
	20	★	MNS0500X20DB	100.9	115.9	118.9	168.9	168	0.9	5	3
30	★	MNS0500X30DB	150.9	165.9	168.9	218.9	218	0.9	5	3	
5.1	3	□	MNS0510S-DIN	20.3	27.9	28.9	65.9	65	0.9	6	4
	3	□	MNS0510S-DIN-C	20.3	27.9	28.9	65.9	65	0.9	6	3
	5	□	MNS0510L-DIN	36.3	43.9	44.9	81.9	81	0.9	6	4
	5	●	MNS0510L-DIN-C	36.3	43.9	44.9	81.9	81	0.9	6	3
	8	□	MNS0510-L8C	41.7	61.9	64.9	101.9	101	0.9	6	3
	10	□	MNS0510-L10C	51.9	72.9	75.9	112.9	112	0.9	6	3
	12	□	MNS0510-L12C	62.1	83.9	86.9	123.9	123	0.9	6	3
	15	□	MNS0510-L15C	77.4	99.9	102.9	139.9	139	0.9	6	3
	20	□	MNS0510-L20C	102.9	127.9	130.9	167.9	167	0.9	6	3
	25	□	MNS0510-L25C	128.4	154.9	157.9	194.9	194	0.9	6	3
	30	□	MNS0510-L30C	153.9	182.9	185.9	222.9	222	0.9	6	3
	5	★	MNS0510LB	26.4	44.9	44.9	100.9	100	0.9	6	3
	10	★	MNS0510X10DB	51.9	72.9	75.9	127.9	127	0.9	6	3
	20	★	MNS0510X20DB	102.9	127.9	130.9	182.9	182	0.9	6	3
30	★	MNS0510X30DB	153.9	182.9	185.9	237.9	237	0.9	6	3	

M

ИНСТРУМЕНТ ДЛЯ
СВЕРЛЕНИЯ

DC (мм)	Глубина сверления (L/D)	TF15	Обозначение	Размеры (мм)							Тип
				LU	LCF	LH	OAL	LF	PL	DCON	
5.2	3	□	MNS0520S-DIN	20.1	27.9	28.9	65.9	65	0.9	6	4
	3	□	MNS0520S-DIN-C	20.1	27.9	28.9	65.9	65	0.9	6	3
	5	□	MNS0520L-DIN	36.1	43.9	44.9	81.9	81	0.9	6	4
	5	□	MNS0520L-DIN-C	36.1	43.9	44.9	81.9	81	0.9	6	3
	8	□	MNS0520-L8C	42.5	61.9	64.9	101.9	101	0.9	6	3
	10	□	MNS0520-L10C	52.9	72.9	75.9	112.9	112	0.9	6	3
	12	□	MNS0520-L12C	63.3	83.9	86.9	123.9	123	0.9	6	3
	15	□	MNS0520-L15C	78.9	99.9	102.9	139.9	139	0.9	6	3
	20	□	MNS0520-L20C	104.9	127.9	130.9	167.9	167	0.9	6	3
	25	□	MNS0520-L25C	130.9	154.9	157.9	194.9	194	0.9	6	3
	30	□	MNS0520-L30C	156.9	182.9	185.9	222.9	222	0.9	6	3
	5	★	MNS0520LB	26.9	44.9	44.9	100.9	100	0.9	6	3
	10	□	MNS0520X10DB	52.9	72.9	75.9	127.9	127	0.9	6	3
20	□	MNS0520X20DB	104.9	127.9	130.9	182.9	182	0.9	6	3	
30	□	MNS0520X30DB	156.9	182.9	185.9	237.9	237	0.9	6	3	
5.3	3	□	MNS0530S-DIN	20.0	28.0	29.0	66.0	65	1.0	6	4
	3	□	MNS0530S-DIN-C	20.0	28.0	29.0	66.0	65	1.0	6	3
	5	□	MNS0530L-DIN	36.0	44.0	45.0	82.0	81	1.0	6	4
	5	□	MNS0530L-DIN-C	36.0	44.0	45.0	82.0	81	1.0	6	3
	8	□	MNS0530-L8C	43.4	62.0	65.0	102.0	101	1.0	6	3
	10	□	MNS0530-L10C	54.0	73.0	76.0	113.0	112	1.0	6	3
	12	□	MNS0530-L12C	64.6	84.0	87.0	124.0	123	1.0	6	3
	15	□	MNS0530-L15C	80.5	100.0	103.0	140.0	139	1.0	6	3
	20	□	MNS0530-L20C	107.0	128.0	131.0	168.0	167	1.0	6	3
	25	□	MNS0530-L25C	133.5	155.0	158.0	195.0	194	1.0	6	3
	30	□	MNS0530-L30C	160.0	183.0	186.0	223.0	222	1.0	6	3
	5	★	MNS0530LB	27.5	45.0	45.0	101.0	100	1.0	6	3
	10	□	MNS0530X10DB	54.0	73.0	76.0	128.0	127	1.0	6	3
20	□	MNS0530X20DB	107.0	128.0	131.0	183.0	182	1.0	6	3	
30	□	MNS0530X30DB	160.0	183.0	186.0	238.0	237	1.0	6	3	
5.4	3	□	MNS0540S-DIN	19.9	28.0	29.0	66.0	65	1.0	6	4
	3	□	MNS0540S-DIN-C	19.9	28.0	29.0	66.0	65	1.0	6	3
	5	□	MNS0540L-DIN	35.9	44.0	45.0	82.0	81	1.0	6	4
	5	□	MNS0540L-DIN-C	35.9	44.0	45.0	82.0	81	1.0	6	3
	8	□	MNS0540-L8C	44.2	62.0	65.0	102.0	101	1.0	6	3
	10	□	MNS0540-L10C	55.0	73.0	76.0	113.0	112	1.0	6	3
	12	□	MNS0540-L12C	65.8	84.0	87.0	124.0	123	1.0	6	3
	15	□	MNS0540-L15C	82.0	100.0	103.0	140.0	139	1.0	6	3
	20	□	MNS0540-L20C	109.0	128.0	131.0	168.0	167	1.0	6	3
	25	□	MNS0540-L25C	136.0	155.0	158.0	195.0	194	1.0	6	3
	30	□	MNS0540-L30C	163.0	183.0	186.0	223.0	222	1.0	6	3
	5	★	MNS0540LB	28.0	45.0	45.0	101.0	100	1.0	6	3
	10	□	MNS0540X10DB	55.0	73.0	76.0	128.0	127	1.0	6	3
20	□	MNS0540X20DB	109.0	128.0	131.0	183.0	182	1.0	6	3	
30	□	MNS0540X30DB	163.0	183.0	186.0	238.0	237	1.0	6	3	

DC (мм)	Глубина сверления (L/D)	TF15	Обозначение	Размеры (мм)							Тип
				LU	LCF	LH	OAL	LF	PL	DCON	
5.5	3	□	MNS0550S-DIN	19.8	28.0	29.0	66.0	65	1.0	6	4
	3	□	MNS0550S-DIN-C	19.8	28.0	29.0	66.0	65	1.0	6	3
	5	□	MNS0550L-DIN	35.8	44.0	45.0	82.0	81	1.0	6	4
	5	●	MNS0550L-DIN-C	35.8	44.0	45.0	82.0	81	1.0	6	3
	8	□	MNS0550-L8C	45.0	62.0	65.0	102.0	101	1.0	6	3
	10	□	MNS0550-L10C	56.0	73.0	76.0	113.0	112	1.0	6	3
	12	●	MNS0550-L12C	67.0	84.0	87.0	124.0	123	1.0	6	3
	15	□	MNS0550-L15C	83.5	100.0	103.0	140.0	139	1.0	6	3
	20	●	MNS0550-L20C	111.0	128.0	131.0	168.0	167	1.0	6	3
	25	□	MNS0550-L25C	138.5	155.0	158.0	195.0	194	1.0	6	3
	30	●	MNS0550-L30C	166.0	183.0	186.0	223.0	222	1.0	6	3
	5	★	MNS0550LB	28.5	45.0	45.0	101.0	100	1.0	6	3
	10	★	MNS0550X10DB	56.0	73.0	76.0	128.0	127	1.0	6	3
20	★	MNS0550X20DB	111.0	128.0	131.0	183.0	182	1.0	6	3	
30	★	MNS0550X30DB	166.0	183.0	186.0	238.0	237	1.0	6	3	
5.55	3	□	MNS0555S-DIN	19.7	28.0	29.0	66.0	65	1.0	6	4
	3	□	MNS0555S-DIN-C	19.7	28.0	29.0	66.0	65	1.0	6	3
	5	□	MNS0555L-DIN	35.7	44.0	45.0	82.0	81	1.0	6	4
	5	●	MNS0555L-DIN-C	35.7	44.0	45.0	82.0	81	1.0	6	3
	5	★	MNS0555LB	29.0	49.0	49.0	101.0	100	1.0	6	3
5.6	3	□	MNS0560S-DIN	19.6	28.0	29.0	66.0	65	1.0	6	4
	3	□	MNS0560S-DIN-C	19.6	28.0	29.0	66.0	65	1.0	6	3
	5	□	MNS0560L-DIN	35.6	44.0	45.0	82.0	81	1.0	6	4
	5	□	MNS0560L-DIN-C	35.6	44.0	45.0	82.0	81	1.0	6	3
	8	□	MNS0560-L8C	45.8	67.0	70.0	107.0	106	1.0	6	3
	10	□	MNS0560-L10C	57.0	79.0	82.0	119.0	118	1.0	6	3
	12	□	MNS0560-L12C	68.2	91.0	94.0	131.0	130	1.0	6	3
	15	□	MNS0560-L15C	85.0	109.0	112.0	149.0	148	1.0	6	3
	20	□	MNS0560-L20C	113.0	139.0	142.0	179.0	178	1.0	6	3
	25	□	MNS0560-L25C	141.0	169.0	172.0	209.0	208	1.0	6	3
	30	□	MNS0560-L30C	169.0	199.0	202.0	239.0	238	1.0	6	3
	10	□	MNS0560X10DB	57.0	79.0	82.0	134.0	133	1.0	6	3
	20	□	MNS0560X20DB	113.0	139.0	142.0	194.0	193	1.0	6	3
30	□	MNS0560X30DB	169.0	199.0	202.0	254.0	253	1.0	6	3	
5.7	3	□	MNS0570S-DIN	19.5	28.0	29.0	66.0	65	1.0	6	4
	3	□	MNS0570S-DIN-C	19.5	28.0	29.0	66.0	65	1.0	6	3
	5	□	MNS0570L-DIN	35.5	44.0	45.0	82.0	81	1.0	6	4
	5	□	MNS0570L-DIN-C	35.5	44.0	45.0	82.0	81	1.0	6	3
	8	□	MNS0570-L8C	46.6	67.0	70.0	107.0	106	1.0	6	3
	10	□	MNS0570-L10C	58.0	79.0	82.0	119.0	118	1.0	6	3
	12	□	MNS0570-L12C	69.4	91.0	94.0	131.0	130	1.0	6	3
	15	□	MNS0570-L15C	86.5	109.0	112.0	149.0	148	1.0	6	3
	20	□	MNS0570-L20C	115.0	139.0	142.0	179.0	178	1.0	6	3
	25	□	MNS0570-L25C	143.5	169.0	172.0	209.0	208	1.0	6	3
	30	□	MNS0570-L30C	172.0	199.0	202.0	239.0	238	1.0	6	3
	5	★	MNS0570LB	29.5	49.0	49.0	101.0	100	1.0	6	3
	10	□	MNS0570X10DB	58.0	79.0	82.0	134.0	133	1.0	6	3
20	□	MNS0570X20DB	115.0	139.0	142.0	194.0	193	1.0	6	3	
30	□	MNS0570X30DB	172.0	199.0	202.0	254.0	253	1.0	6	3	

Примечание 1) Пожалуйста, свяжитесь с нами если Вы не нашли нужную геометрию в данном каталоге (могут быть заказаны другие диаметры и длины).

● : Есть на складе. ★ : Со склада в Японии.

□ : Нет на складе, выпускается исключительно под заказ.

DC (мм)	Глубина сверления (L/D)	TF15	Обозначение	Размеры (мм)							Тип
				LU	LCF	LH	OAL	LF	PL	DCON	
5.8	3	□	MNS0580S-DIN	19.4	28.1	29.1	66.1	65	1.1	6	4
	3	□	MNS0580S-DIN-C	19.4	28.1	29.1	66.1	65	1.1	6	3
	5	□	MNS0580L-DIN	35.4	44.1	45.1	82.1	81	1.1	6	4
	5	□	MNS0580L-DIN-C	35.4	44.1	45.1	82.1	81	1.1	6	3
	8	□	MNS0580-L8C	47.5	67.1	70.1	107.1	106	1.1	6	3
	10	□	MNS0580-L10C	59.1	79.1	82.1	119.1	118	1.1	6	3
	12	□	MNS0580-L12C	70.7	91.1	94.1	131.1	130	1.1	6	3
	15	□	MNS0580-L15C	88.1	109.1	112.1	149.1	148	1.1	6	3
	20	□	MNS0580-L20C	117.1	139.1	142.1	179.1	178	1.1	6	3
	25	□	MNS0580-L25C	146.1	169.1	172.1	209.1	208	1.1	6	3
	30	□	MNS0580-L30C	175.1	199.1	202.1	239.1	238	1.1	6	3
	5	★	MNS0580LB	30.1	49.1	49.1	101.1	100	1.1	6	3
	10	□	MNS0580X10DB	59.1	79.1	82.1	134.1	133	1.1	6	3
20	□	MNS0580X20DB	117.1	139.1	142.1	194.1	193	1.1	6	3	
30	□	MNS0580X30DB	175.1	199.1	202.1	254.1	253	1.1	6	3	
5.9	3	□	MNS0590S-DIN	19.2	28.1	29.1	66.1	65	1.1	6	4
	3	□	MNS0590S-DIN-C	19.2	28.1	29.1	66.1	65	1.1	6	3
	5	□	MNS0590L-DIN	35.2	44.1	45.1	82.1	81	1.1	6	4
	5	□	MNS0590L-DIN-C	35.2	44.1	45.1	82.1	81	1.1	6	3
	8	□	MNS0590-L8C	48.3	67.1	70.1	107.1	106	1.1	6	3
	10	□	MNS0590-L10C	60.1	79.1	82.1	119.1	118	1.1	6	3
	12	□	MNS0590-L12C	71.9	91.1	94.1	131.1	130	1.1	6	3
	15	□	MNS0590-L15C	89.6	109.1	112.1	149.1	148	1.1	6	3
	20	□	MNS0590-L20C	119.1	139.1	142.1	179.1	178	1.1	6	3
	25	□	MNS0590-L25C	148.6	169.1	172.1	209.1	208	1.1	6	3
	30	□	MNS0590-L30C	178.1	199.1	202.1	239.1	238	1.1	6	3
	5	★	MNS0590LB	30.6	49.1	49.1	101.1	100	1.1	6	3
	10	□	MNS0590X10DB	60.1	79.1	82.1	134.1	133	1.1	6	3
20	□	MNS0590X20DB	119.1	139.1	142.1	194.1	193	1.1	6	3	
30	□	MNS0590X30DB	178.1	199.1	202.1	254.1	253	1.1	6	3	
6.0	3	□	MNS0600S-DIN	19.1	28.1	29.1	66.1	65	1.1	6	4
	3	□	MNS0600S-DIN-C	19.1	28.1	29.1	66.1	65	1.1	6	3
	5	●	MNS0600L-DIN-C	35.1	44.1	45.1	82.1	81	1.1	6	3
	8	□	MNS0600-L8C	49.1	67.1	70.1	107.1	106	1.1	6	3
	10	□	MNS0600-L10C	61.1	79.1	82.1	119.1	118	1.1	6	3
	12	●	MNS0600-L12C	73.1	91.1	94.1	131.1	130	1.1	6	3
	15	□	MNS0600-L15C	91.1	109.1	112.1	149.1	148	1.1	6	3
	20	●	MNS0600-L20C	121.1	139.1	142.1	179.1	178	1.1	6	3
	25	□	MNS0600-L25C	151.1	169.1	172.1	209.1	208	1.1	6	3
	30	●	MNS0600-L30C	181.1	199.1	202.1	239.1	238	1.1	6	3
	5	★	MNS0600LB	31.1	49.1	49.1	101.1	100	1.1	6	3
	10	★	MNS0600X10DB	61.1	79.1	82.1	134.1	133	1.1	6	3
	20	★	MNS0600X20DB	121.1	139.1	142.1	194.1	193	1.1	6	3
30	★	MNS0600X30DB	181.1	199.1	202.1	254.1	253	1.1	6	3	

DC (мм)	Глубина сверления (L/D)	TF15	Обозначение	Размеры (мм)							Тип
				LU	LCF	LH	OAL	LF	PL	DCON	
6.1	3	□	MNS0610S-DIN	25.0	34.1	42.1	79.1	78	1.1	8	4
	3	□	MNS0610S-DIN-C	25.0	34.1	42.1	79.1	78	1.1	8	3
	5	□	MNS0610L-DIN	44.0	53.1	54.1	91.1	90	1.1	8	4
	5	□	MNS0610L-DIN-C	44.0	53.1	54.1	91.1	90	1.1	8	3
	8	□	MNS0610-L8C	49.9	73.1	76.1	113.1	112	1.1	8	3
	10	□	MNS0610-L10C	62.1	86.1	89.1	126.1	125	1.1	8	3
	12	□	MNS0610-L12C	74.3	99.1	102.1	139.1	138	1.1	8	3
	15	□	MNS0610-L15C	92.6	118.1	121.1	158.1	157	1.1	8	3
	20	□	MNS0610-L20C	123.1	151.1	154.1	191.1	190	1.1	8	3
	25	□	MNS0610-L25C	153.6	183.1	186.1	223.1	222	1.1	8	3
	30	□	MNS0610-L30C	184.1	216.1	219.1	256.1	255	1.1	8	3
	5	★	MNS0610LB	31.6	53.1	53.1	110.1	109	1.1	7	3
	10	★	MNS0610X10DB	62.1	86.1	89.1	142.1	141	1.1	7	3
20	★	MNS0610X20DB	123.1	151.1	154.1	207.1	206	1.1	7	3	
30	★	MNS0610X30DB	184.1	216.1	219.1	272.1	271	1.1	7	3	
6.2	3	□	MNS0620S-DIN	24.8	34.1	42.1	79.1	78	1.1	8	4
	3	□	MNS0620S-DIN-C	24.8	34.1	42.1	79.1	78	1.1	8	3
	5	□	MNS0620L-DIN	43.8	53.1	54.1	91.1	90	1.1	8	4
	5	□	MNS0620L-DIN-C	43.8	53.1	54.1	91.1	90	1.1	8	3
	8	□	MNS0620-L8C	50.7	73.1	76.1	113.1	112	1.1	8	3
	10	□	MNS0620-L10C	63.1	86.1	89.1	126.1	125	1.1	8	3
	12	□	MNS0620-L12C	75.5	99.1	102.1	139.1	138	1.1	8	3
	15	□	MNS0620-L15C	94.1	118.1	121.1	158.1	157	1.1	8	3
	20	□	MNS0620-L20C	125.1	151.1	154.1	191.1	190	1.1	8	3
	25	□	MNS0620-L25C	156.1	183.1	186.1	223.1	222	1.1	8	3
	30	□	MNS0620-L30C	187.1	216.1	219.1	256.1	255	1.1	8	3
	5	★	MNS0620LB	32.1	53.1	53.1	110.1	109	1.1	7	3
	10	□	MNS0620X10DB	63.1	86.1	89.1	142.1	141	1.1	7	3
20	□	MNS0620X20DB	125.1	151.1	154.1	207.1	206	1.1	7	3	
30	□	MNS0620X30DB	187.1	216.1	219.1	272.1	271	1.1	7	3	
6.3	3	□	MNS0630S-DIN	24.7	34.1	42.1	79.1	78	1.1	8	4
	3	□	MNS0630S-DIN-C	24.7	34.1	42.1	79.1	78	1.1	8	3
	5	□	MNS0630L-DIN	43.7	53.1	54.1	91.1	90	1.1	8	4
	5	□	MNS0630L-DIN-C	43.7	53.1	54.1	91.1	90	1.1	8	3
	8	□	MNS0630-L8C	51.5	73.1	76.1	113.1	112	1.1	8	3
	10	□	MNS0630-L10C	64.1	86.1	89.1	126.1	125	1.1	8	3
	12	□	MNS0630-L12C	76.7	99.1	102.1	139.1	138	1.1	8	3
	15	□	MNS0630-L15C	95.6	118.1	121.1	158.1	157	1.1	8	3
	20	□	MNS0630-L20C	127.1	151.1	154.1	191.1	190	1.1	8	3
	25	□	MNS0630-L25C	158.6	183.1	186.1	223.1	222	1.1	8	3
	30	□	MNS0630-L30C	190.1	216.1	219.1	256.1	255	1.1	8	3
	5	★	MNS0630LB	32.6	53.1	53.1	110.1	109	1.1	7	3
	10	□	MNS0630X10DB	64.1	86.1	89.1	142.1	141	1.1	7	3
20	□	MNS0630X20DB	127.1	151.1	154.1	207.1	206	1.1	7	3	
30	□	MNS0630X30DB	190.1	216.1	219.1	272.1	271	1.1	7	3	

М
ИНСТРУМЕНТ ДЛЯ
СВЕРЛЕНИЯ

DC (мм)	Глубина сверления (L/D)	TF15	Обозначение	Размеры (мм)							Тип
				LU	LCF	LH	OAL	LF	PL	DCON	
6.4	3	□	MNS0640S-DIN	24.6	34.2	42.2	79.2	78	1.2	8	4
	3	□	MNS0640S-DIN-C	24.6	34.2	42.2	79.2	78	1.2	8	3
	5	□	MNS0640L-DIN	43.6	53.2	54.2	91.2	90	1.2	8	4
	5	□	MNS0640L-DIN-C	43.6	53.2	54.2	91.2	90	1.2	8	3
	8	□	MNS0640-L8C	52.4	73.2	76.2	113.2	112	1.2	8	3
	10	□	MNS0640-L10C	65.2	86.2	89.2	126.2	125	1.2	8	3
	12	□	MNS0640-L12C	78.0	99.2	102.2	139.2	138	1.2	8	3
	15	□	MNS0640-L15C	97.2	118.2	121.2	158.2	157	1.2	8	3
	20	□	MNS0640-L20C	129.2	151.2	154.2	191.2	190	1.2	8	3
	25	□	MNS0640-L25C	161.2	183.2	186.2	223.2	222	1.2	8	3
	30	□	MNS0640-L30C	193.2	216.2	219.2	256.2	255	1.2	8	3
	5	★	MNS0640LB	33.2	53.2	53.2	110.2	109	1.2	7	3
	10	□	MNS0640X10DB	65.2	86.2	89.2	142.2	141	1.2	7	3
20	□	MNS0640X20DB	129.2	151.2	154.2	207.2	206	1.2	7	3	
30	□	MNS0640X30DB	193.2	216.2	219.2	272.2	271	1.2	7	3	
6.5	3	□	MNS0650S-DIN	24.4	34.2	42.2	79.2	78	1.2	8	4
	3	□	MNS0650S-DIN-C	24.4	34.2	42.2	79.2	78	1.2	8	3
	5	□	MNS0650L-DIN	43.4	53.2	54.2	91.2	90	1.2	8	4
	5	●	MNS0650L-DIN-C	43.4	53.2	54.2	91.2	90	1.2	8	3
	8	□	MNS0650-L8C	53.2	73.2	76.2	113.2	112	1.2	8	3
	10	□	MNS0650-L10C	66.2	86.2	89.2	126.2	125	1.2	8	3
	12	●	MNS0650-L12C	79.2	99.2	102.2	139.2	138	1.2	8	3
	15	□	MNS0650-L15C	98.7	118.2	121.2	158.2	157	1.2	8	3
	20	●	MNS0650-L20C	131.2	151.2	154.2	191.2	190	1.2	8	3
	25	□	MNS0650-L25C	163.7	183.2	186.2	223.2	222	1.2	8	3
	30	●	MNS0650-L30C	196.2	216.2	219.2	256.2	255	1.2	8	3
	5	★	MNS0650LB	33.7	53.2	53.2	110.2	109	1.2	7	3
	10	★	MNS0650X10DB	66.2	86.2	89.2	142.2	141	1.2	7	3
20	★	MNS0650X20DB	131.2	151.2	154.2	207.2	206	1.2	7	3	
30	★	MNS0650X30DB	196.2	216.2	219.2	272.2	271	1.2	7	3	
6.6	3	□	MNS0660S-DIN	24.3	34.2	42.2	79.2	78	1.2	8	4
	3	□	MNS0660S-DIN-C	24.3	34.2	42.2	79.2	78	1.2	8	3
	5	□	MNS0660L-DIN	43.3	53.2	54.2	91.2	90	1.2	8	4
	5	□	MNS0660L-DIN-C	43.3	53.2	54.2	91.2	90	1.2	8	3
	8	□	MNS0660-L8C	54.0	78.2	81.2	118.2	117	1.2	8	3
	10	□	MNS0660-L10C	67.2	92.2	95.2	132.2	131	1.2	8	3
	12	□	MNS0660-L12C	80.4	106.2	109.2	146.2	145	1.2	8	3
	15	□	MNS0660-L15C	100.2	127.2	130.2	167.2	166	1.2	8	3
	20	□	MNS0660-L20C	133.2	162.2	165.2	202.2	201	1.2	8	3
	25	□	MNS0660-L25C	166.2	197.2	200.2	237.2	236	1.2	8	3
	30	□	MNS0660-L30C	199.2	232.2	235.2	272.2	271	1.2	8	3
	5	★	MNS0660LB	34.2	57.2	57.2	110.2	109	1.2	7	3
	10	□	MNS0660X10DB	67.2	92.2	95.2	148.2	147	1.2	7	3
20	□	MNS0660X20DB	133.2	162.2	165.2	218.2	217	1.2	7	3	
30	□	MNS0660X30DB	199.2	232.2	235.2	288.2	287	1.2	7	3	

DC (мм)	Глубина сверления (L/D)	TF15	Обозначение	Размеры (мм)							Тип
				LU	LCF	LH	OAL	LF	PL	DCON	
6.7	3	□	MNS0670S-DIN	24.2	34.2	42.2	79.2	78	1.2	8	4
	3	□	MNS0670S-DIN-C	24.2	34.2	42.2	79.2	78	1.2	8	3
	5	□	MNS0670L-DIN	43.2	53.2	54.2	91.2	90	1.2	8	4
	5	□	MNS0670L-DIN-C	43.2	53.2	54.2	91.2	90	1.2	8	3
	8	□	MNS0670-L8C	54.8	78.2	81.2	118.2	117	1.2	8	3
	10	□	MNS0670-L10C	68.2	92.2	95.2	132.2	131	1.2	8	3
	12	□	MNS0670-L12C	81.6	106.2	109.2	146.2	145	1.2	8	3
	15	□	MNS0670-L15C	101.7	127.2	130.2	167.2	166	1.2	8	3
	20	□	MNS0670-L20C	135.2	162.2	165.2	202.2	201	1.2	8	3
	25	□	MNS0670-L25C	168.7	197.2	200.2	237.2	236	1.2	8	3
	30	□	MNS0670-L30C	202.2	232.2	235.2	272.2	271	1.2	8	3
	5	★	MNS0670LB	34.7	57.2	57.2	110.2	109	1.2	7	3
	10	★	MNS0670X10DB	68.2	92.2	95.2	148.2	147	1.2	7	3
20	★	MNS0670X20DB	135.2	162.2	165.2	218.2	217	1.2	7	3	
30	★	MNS0670X30DB	202.2	232.2	235.2	288.2	287	1.2	7	3	
6.8	3	□	MNS0680S-DIN	24.0	34.2	42.2	79.2	78	1.2	8	4
	3	□	MNS0680S-DIN-C	24.0	34.2	42.2	79.2	78	1.2	8	3
	5	□	MNS0680L-DIN	43.0	53.2	54.2	91.2	90	1.2	8	4
	5	●	MNS0680L-DIN-C	43.0	53.2	54.2	91.2	90	1.2	8	3
	8	□	MNS0680-L8C	55.6	78.2	81.2	118.2	117	1.2	8	3
	10	□	MNS0680-L10C	69.2	92.2	95.2	132.2	131	1.2	8	3
	12	●	MNS0680-L12C	82.8	106.2	109.2	146.2	145	1.2	8	3
	15	□	MNS0680-L15C	103.2	127.2	130.2	167.2	166	1.2	8	3
	20	●	MNS0680-L20C	137.2	162.2	165.2	202.2	201	1.2	8	3
	25	□	MNS0680-L25C	171.2	197.2	200.2	237.2	236	1.2	8	3
	30	●	MNS0680-L30C	205.2	232.2	235.2	272.2	271	1.2	8	3
	5	★	MNS0680LB	35.2	57.2	57.2	110.2	109	1.2	7	3
	10	□	MNS0680X10DB	69.2	92.2	95.2	148.2	147	1.2	7	3
20	□	MNS0680X20DB	137.2	162.2	165.2	218.2	217	1.2	7	3	
30	□	MNS0680X30DB	205.2	232.2	235.2	288.2	287	1.2	7	3	
6.9	3	□	MNS0690S-DIN	23.9	34.3	42.3	79.3	78	1.3	8	4
	3	□	MNS0690S-DIN-C	23.9	34.3	42.3	79.3	78	1.3	8	3
	5	□	MNS0690L-DIN	42.9	53.3	54.3	91.3	90	1.3	8	4
	5	□	MNS0690L-DIN-C	42.9	53.3	54.3	91.3	90	1.3	8	3
	8	□	MNS0690-L8C	56.5	78.3	81.3	118.3	117	1.3	8	3
	10	□	MNS0690-L10C	70.3	92.3	95.3	132.3	131	1.3	8	3
	12	□	MNS0690-L12C	84.1	106.3	109.3	146.3	145	1.3	8	3
	15	□	MNS0690-L15C	104.8	127.3	130.3	167.3	166	1.3	8	3
	20	□	MNS0690-L20C	139.3	162.3	165.3	202.3	201	1.3	8	3
	25	□	MNS0690-L25C	173.8	197.3	200.3	237.3	236	1.3	8	3
	30	□	MNS0690-L30C	208.3	232.3	235.3	272.3	271	1.3	8	3
	5	★	MNS0690LB	35.8	57.3	57.3	110.3	109	1.3	7	3
	10	□	MNS0690X10DB	70.3	92.3	95.3	148.3	147	1.3	7	3
20	□	MNS0690X20DB	139.3	162.3	165.3	218.3	217	1.3	7	3	
30	□	MNS0690X30DB	208.3	232.3	235.3	288.3	287	1.3	7	3	

Примечание 1) Пожалуйста, свяжитесь с нами если Вы не нашли нужную геометрию в данном каталоге (могут быть заказаны другие диаметры и длины).

● : Есть на складе. ★ : Со склада в Японии.

□ : Нет на складе, выпускается исключительно под заказ.

DC (мм)	Глубина сверления (L/D)	TF15	Обозначение	Размеры (мм)							Тип
				LU	LCF	LH	OAL	LF	PL	DCON	
7.0	3	□	MNS0700S-DIN	23.8	34.3	42.3	79.3	78	1.3	8	4
	3	□	MNS0700S-DIN-C	23.8	34.3	42.3	79.3	78	1.3	8	3
	5	□	MNS0700L-DIN	42.8	53.3	54.3	91.3	90	1.3	8	4
	5	●	MNS0700L-DIN-C	42.8	53.3	54.3	91.3	90	1.3	8	3
	8	□	MNS0700-L8C	57.3	78.3	81.3	118.3	117	1.3	8	3
	10	□	MNS0700-L10C	71.3	92.3	95.3	132.3	131	1.3	8	3
	12	●	MNS0700-L12C	85.3	106.3	109.3	146.3	145	1.3	8	3
	15	□	MNS0700-L15C	106.3	127.3	130.3	167.3	166	1.3	8	3
	20	●	MNS0700-L20C	141.3	162.3	165.3	202.3	201	1.3	8	3
	25	□	MNS0700-L25C	176.3	197.3	200.3	237.3	236	1.3	8	3
	30	●	MNS0700-L30C	211.3	232.3	235.3	272.3	271	1.3	8	3
	5	★	MNS0700LB	36.3	57.3	57.3	110.3	109	1.3	7	3
	10	★	MNS0700X10DB	71.3	92.3	95.3	148.3	147	1.3	7	3
	20	★	MNS0700X20DB	141.3	162.3	165.3	218.3	217	1.3	7	3
30	★	MNS0700X30DB	211.3	232.3	235.3	288.3	287	1.3	7	3	
7.1	3	□	MNS0710S-DIN	30.6	41.3	42.3	79.3	78	1.3	8	4
	3	□	MNS0710S-DIN-C	30.6	41.3	42.3	79.3	78	1.3	8	3
	5	□	MNS0710L-DIN	42.6	53.3	54.3	91.3	90	1.3	8	4
	5	□	MNS0710L-DIN-C	42.6	53.3	54.3	91.3	90	1.3	8	3
	8	□	MNS0710-L8C	58.1	84.3	87.3	124.3	123	1.3	8	3
	10	□	MNS0710-L10C	72.3	99.3	102.3	139.3	138	1.3	8	3
	12	□	MNS0710-L12C	86.5	114.3	117.3	154.3	153	1.3	8	3
	15	□	MNS0710-L15C	107.8	136.3	139.3	176.3	175	1.3	8	3
	20	□	MNS0710-L20C	143.3	174.3	177.3	214.3	213	1.3	8	3
	25	□	MNS0710-L25C	178.8	211.3	214.3	251.3	250	1.3	8	3
	30	□	MNS0710-L30C	214.3	249.3	252.3	289.3	288	1.3	8	3
	5	★	MNS0710LB	36.8	61.3	65.3	119.3	118	1.3	8	3
	10	□	MNS0710X10DB	72.3	99.3	102.3	156.3	155	1.3	8	3
	20	□	MNS0710X20DB	143.3	174.3	177.3	231.3	230	1.3	8	3
30	□	MNS0710X30DB	214.3	249.3	252.3	306.3	305	1.3	8	3	
7.2	3	□	MNS0720S-DIN	30.5	41.3	42.3	79.3	78	1.3	8	4
	3	□	MNS0720S-DIN-C	30.5	41.3	42.3	79.3	78	1.3	8	3
	5	□	MNS0720L-DIN	42.5	53.3	54.3	91.3	90	1.3	8	4
	5	□	MNS0720L-DIN-C	42.5	53.3	54.3	91.3	90	1.3	8	3
	8	□	MNS0720-L8C	58.9	84.3	87.3	124.3	123	1.3	8	3
	10	□	MNS0720-L10C	73.3	99.3	102.3	139.3	138	1.3	8	3
	12	□	MNS0720-L12C	87.7	114.3	117.3	154.3	153	1.3	8	3
	15	□	MNS0720-L15C	109.3	136.3	139.3	176.3	175	1.3	8	3
	20	□	MNS0720-L20C	145.3	174.3	177.3	214.3	213	1.3	8	3
	25	□	MNS0720-L25C	181.3	211.3	214.3	251.3	250	1.3	8	3
	30	□	MNS0720-L30C	217.3	249.3	252.3	289.3	288	1.3	8	3
	5	★	MNS0720LB	37.3	61.3	65.3	119.3	118	1.3	8	3
	10	★	MNS0720X10DB	73.3	99.3	102.3	156.3	155	1.3	8	3
	20	★	MNS0720X20DB	145.3	174.3	177.3	231.3	230	1.3	8	3
30	★	MNS0720X30DB	217.3	249.3	252.3	306.3	305	1.3	8	3	

DC (мм)	Глубина сверления (L/D)	TF15	Обозначение	Размеры (мм)							Тип
				LU	LCF	LH	OAL	LF	PL	DCON	
7.3	3	□	MNS0730S-DIN	30.4	41.3	42.3	79.3	78	1.3	8	4
	3	□	MNS0730S-DIN-C	30.4	41.3	42.3	79.3	78	1.3	8	3
	5	□	MNS0730L-DIN	42.4	53.3	54.3	91.3	90	1.3	8	4
	5	□	MNS0730L-DIN-C	42.4	53.3	54.3	91.3	90	1.3	8	3
	8	□	MNS0730-L8C	59.7	84.3	87.3	124.3	123	1.3	8	3
	10	□	MNS0730-L10C	74.3	99.3	102.3	139.3	138	1.3	8	3
	12	□	MNS0730-L12C	88.9	114.3	117.3	154.3	153	1.3	8	3
	15	□	MNS0730-L15C	110.8	136.3	139.3	176.3	175	1.3	8	3
	20	□	MNS0730-L20C	147.3	174.3	177.3	214.3	213	1.3	8	3
	25	□	MNS0730-L25C	183.8	211.3	214.3	251.3	250	1.3	8	3
	30	□	MNS0730-L30C	220.3	249.3	252.3	289.3	288	1.3	8	3
	5	★	MNS0730LB	37.8	61.3	65.3	119.3	118	1.3	8	3
	10	□	MNS0730X10DB	74.3	99.3	102.3	156.3	155	1.3	8	3
	20	□	MNS0730X20DB	147.3	174.3	177.3	231.3	230	1.3	8	3
30	□	MNS0730X30DB	220.3	249.3	252.3	306.3	305	1.3	8	3	
7.4	3	□	MNS0740S-DIN	30.2	41.3	42.3	79.3	78	1.3	8	4
	3	□	MNS0740S-DIN-C	30.2	41.3	42.3	79.3	78	1.3	8	3
	5	□	MNS0740L-DIN	42.2	53.3	54.3	91.3	90	1.3	8	4
	5	□	MNS0740L-DIN-C	42.2	53.3	54.3	91.3	90	1.3	8	3
	8	□	MNS0740-L8C	60.5	84.3	87.3	124.3	123	1.3	8	3
	10	□	MNS0740-L10C	75.3	99.3	102.3	139.3	138	1.3	8	3
	12	□	MNS0740-L12C	90.1	114.3	117.3	154.3	153	1.3	8	3
	15	□	MNS0740-L15C	112.3	136.3	139.3	176.3	175	1.3	8	3
	20	□	MNS0740-L20C	149.3	174.3	177.3	214.3	213	1.3	8	3
	25	□	MNS0740-L25C	186.3	211.3	214.3	251.3	250	1.3	8	3
	30	□	MNS0740-L30C	223.3	249.3	252.3	289.3	288	1.3	8	3
	5	★	MNS0740LB	38.3	61.3	65.3	119.3	118	1.3	8	3
	10	□	MNS0740X10DB	75.3	99.3	102.3	156.3	155	1.3	8	3
	20	□	MNS0740X20DB	149.3	174.3	177.3	231.3	230	1.3	8	3
30	□	MNS0740X30DB	223.3	249.3	252.3	306.3	305	1.3	8	3	
7.5	3	□	MNS0750S-DIN	30.1	41.4	42.4	79.4	78	1.4	8	4
	3	□	MNS0750S-DIN-C	30.1	41.4	42.4	79.4	78	1.4	8	3
	5	□	MNS0750L-DIN	42.1	53.4	54.4	91.4	90	1.4	8	4
	5	●	MNS0750L-DIN-C	42.1	53.4	54.4	91.4	90	1.4	8	3
	8	□	MNS0750-L8C	61.4	84.4	87.4	124.4	123	1.4	8	3
	10	□	MNS0750-L10C	76.4	99.4	102.4	139.4	138	1.4	8	3
	12	●	MNS0750-L12C	91.4	114.4	117.4	154.4	153	1.4	8	3
	15	□	MNS0750-L15C	113.9	136.4	139.4	176.4	175	1.4	8	3
	20	●	MNS0750-L20C	151.4	174.4	177.4	214.4	213	1.4	8	3
	25	□	MNS0750-L25C	188.9	211.4	214.4	251.4	250	1.4	8	3
	30	●	MNS0750-L30C	226.4	249.4	252.4	289.4	288	1.4	8	3
	5	★	MNS0750LB	38.9	61.4	65.4	119.4	118	1.4	8	3
	10	□	MNS0750X10DB	76.4	99.4	102.4	156.4	155	1.4	8	3
	20	□	MNS0750X20DB	151.4	174.4	177.4	231.4	230	1.4	8	3
30	□	MNS0750X30DB	226.4	249.4	252.4	306.4	305	1.4	8	3	

М
ИНСТРУМЕНТ ДЛЯ
СВЕРЛЕНИЯ

DC (мм)	Глубина сверления (L/D)	TF15	Обозначение	Размеры (мм)							Тип
				LU	LCF	LH	OAL	LF	PL	DCON	
7.6	3	□	MNS0760S-DIN	30.0	41.4	42.4	79.4	78	1.4	8	4
	3	□	MNS0760S-DIN-C	30.0	41.4	42.4	79.4	78	1.4	8	3
	5	□	MNS0760L-DIN	42.0	53.4	54.4	91.4	90	1.4	8	4
	5	□	MNS0760L-DIN-C	42.0	53.4	54.4	91.4	90	1.4	8	3
	8	□	MNS0760-L8C	62.2	89.4	92.4	129.4	128	1.4	8	3
	10	□	MNS0760-L10C	77.4	105.4	108.4	145.4	144	1.4	8	3
	12	□	MNS0760-L12C	92.6	121.4	124.4	161.4	160	1.4	8	3
	15	□	MNS0760-L15C	115.4	145.4	148.4	185.4	184	1.4	8	3
	20	□	MNS0760-L20C	153.4	185.4	188.4	225.4	224	1.4	8	3
	25	□	MNS0760-L25C	191.4	225.4	228.4	265.4	264	1.4	8	3
	30	□	MNS0760-L30C	229.4	265.4	268.4	305.4	304	1.4	8	3
	5	★	MNS0760LB	39.4	65.4	65.4	119.4	118	1.4	8	3
	10	□	MNS0760X10DB	77.4	105.4	108.4	162.4	161	1.4	8	3
20	□	MNS0760X20DB	153.4	185.4	188.4	242.4	241	1.4	8	3	
30	□	MNS0760X30DB	229.4	265.4	268.4	322.4	321	1.4	8	3	
7.7	3	□	MNS0770S-DIN	29.9	41.4	42.4	79.4	78	1.4	8	4
	3	□	MNS0770S-DIN-C	29.9	41.4	42.4	79.4	78	1.4	8	3
	5	□	MNS0770L-DIN	41.9	53.4	54.4	91.4	90	1.4	8	4
	5	□	MNS0770L-DIN-C	41.9	53.4	54.4	91.4	90	1.4	8	3
	8	□	MNS0770-L8C	63.0	89.4	92.4	129.4	128	1.4	8	3
	10	□	MNS0770-L10C	78.4	105.4	108.4	145.4	144	1.4	8	3
	12	□	MNS0770-L12C	93.8	121.4	124.4	161.4	160	1.4	8	3
	15	□	MNS0770-L15C	116.9	145.4	148.4	185.4	184	1.4	8	3
	20	□	MNS0770-L20C	155.4	185.4	188.4	225.4	224	1.4	8	3
	25	□	MNS0770-L25C	193.9	225.4	228.4	265.4	264	1.4	8	3
	30	□	MNS0770-L30C	232.4	265.4	268.4	305.4	304	1.4	8	3
	5	★	MNS0770LB	39.9	65.4	65.4	119.4	118	1.4	8	3
	10	□	MNS0770X10DB	78.4	105.4	108.4	162.4	161	1.4	8	3
20	□	MNS0770X20DB	155.4	185.4	188.4	242.4	241	1.4	8	3	
30	□	MNS0770X30DB	232.4	265.4	268.4	322.4	321	1.4	8	3	
7.8	3	□	MNS0780S-DIN	29.7	41.4	42.4	79.4	78	1.4	8	4
	3	□	MNS0780S-DIN-C	29.7	41.4	42.4	79.4	78	1.4	8	3
	5	□	MNS0780L-DIN	41.7	53.4	54.4	91.4	90	1.4	8	4
	5	□	MNS0780L-DIN-C	41.7	53.4	54.4	91.4	90	1.4	8	3
	8	□	MNS0780-L8C	63.8	89.4	92.4	129.4	128	1.4	8	3
	10	□	MNS0780-L10C	79.4	105.4	108.4	145.4	144	1.4	8	3
	12	□	MNS0780-L12C	95.0	121.4	124.4	161.4	160	1.4	8	3
	15	□	MNS0780-L15C	118.4	145.4	148.4	185.4	184	1.4	8	3
	20	□	MNS0780-L20C	157.4	185.4	188.4	225.4	224	1.4	8	3
	25	□	MNS0780-L25C	196.4	225.4	228.4	265.4	264	1.4	8	3
	30	□	MNS0780-L30C	235.4	265.4	268.4	305.4	304	1.4	8	3
	5	★	MNS0780LB	40.4	65.4	65.4	119.4	118	1.4	8	3
	10	★	MNS0780X10DB	79.4	105.4	108.4	162.4	161	1.4	8	3
20	★	MNS0780X20DB	157.4	185.4	188.4	242.4	241	1.4	8	3	
30	★	MNS0780X30DB	235.4	265.4	268.4	322.4	321	1.4	8	3	

DC (мм)	Глубина сверления (L/D)	TF15	Обозначение	Размеры (мм)							Тип
				LU	LCF	LH	OAL	LF	PL	DCON	
7.9	3	□	MNS0790S-DIN	29.6	41.4	42.4	79.4	78	1.4	8	4
	3	□	MNS0790S-DIN-C	29.6	41.4	42.4	79.4	78	1.4	8	3
	5	□	MNS0790L-DIN	41.6	53.4	54.4	91.4	90	1.4	8	4
	5	□	MNS0790L-DIN-C	41.6	53.4	54.4	91.4	90	1.4	8	3
	8	□	MNS0790-L8C	64.6	89.4	92.4	129.4	128	1.4	8	3
	10	□	MNS0790-L10C	80.4	105.4	108.4	145.4	144	1.4	8	3
	12	□	MNS0790-L12C	96.2	121.4	124.4	161.4	160	1.4	8	3
	15	□	MNS0790-L15C	119.9	145.4	148.4	185.4	184	1.4	8	3
	20	□	MNS0790-L20C	159.4	185.4	188.4	225.4	224	1.4	8	3
	25	□	MNS0790-L25C	198.9	225.4	228.4	265.4	264	1.4	8	3
	30	□	MNS0790-L30C	238.4	265.4	268.4	305.4	304	1.4	8	3
	5	★	MNS0790LB	40.9	65.4	65.4	119.4	118	1.4	8	3
	10	□	MNS0790X10DB	80.4	105.4	108.4	162.4	161	1.4	8	3
20	□	MNS0790X20DB	159.4	185.4	188.4	242.4	241	1.4	8	3	
30	□	MNS0790X30DB	238.4	265.4	268.4	322.4	321	1.4	8	3	
8.0	3	□	MNS0800S-DIN	29.5	41.5	42.5	79.5	78	1.5	8	4
	3	□	MNS0800S-DIN-C	29.5	41.5	42.5	79.5	78	1.5	8	3
	5	□	MNS0800L-DIN	41.5	53.5	54.5	91.5	90	1.5	8	4
	5	●	MNS0800L-DIN-C	41.5	53.5	54.5	91.5	90	1.5	8	3
	8	□	MNS0800-L8C	65.5	89.5	92.5	129.5	128	1.5	8	3
	10	□	MNS0800-L10C	81.5	105.5	108.5	145.5	144	1.5	8	3
	12	●	MNS0800-L12C	97.5	121.5	124.5	161.5	160	1.5	8	3
	15	□	MNS0800-L15C	121.5	145.5	148.5	185.5	184	1.5	8	3
	20	●	MNS0800-L20C	161.5	185.5	188.5	225.5	224	1.5	8	3
	25	□	MNS0800-L25C	201.5	225.5	228.5	265.5	264	1.5	8	3
	30	●	MNS0800-L30C	241.5	265.5	268.5	305.5	304	1.5	8	3
	5	★	MNS0800LB	41.5	65.5	65.5	119.5	118	1.5	8	3
	10	★	MNS0800X10DB	81.5	105.5	108.5	162.5	161	1.5	8	3
20	★	MNS0800X20DB	161.5	185.5	188.5	242.5	241	1.5	8	3	
30	★	MNS0800X30DB	241.5	265.5	268.5	322.5	321	1.5	8	3	
8.1	3	□	MNS0810S-DIN	34.3	46.5	47.5	88.5	87	1.5	10	4
	3	□	MNS0810S-DIN-C	34.3	46.5	47.5	88.5	87	1.5	10	3
	5	□	MNS0810L-DIN	48.3	60.5	61.5	102.5	101	1.5	10	4
	5	□	MNS0810L-DIN-C	48.3	60.5	61.5	102.5	101	1.5	10	3
	8	□	MNS0810-L8C	66.3	95.5	98.5	139.5	138	1.5	10	3
	10	□	MNS0810-L10C	82.5	112.5	115.5	156.5	155	1.5	10	3
	12	□	MNS0810-L12C	98.7	129.5	132.5	173.5	172	1.5	10	3
	15	□	MNS0810-L15C	123.0	154.5	157.5	198.5	197	1.5	10	3
	20	□	MNS0810-L20C	163.5	197.5	200.5	241.5	240	1.5	10	3
	25	□	MNS0810-L25C	204.0	239.5	242.5	283.5	282	1.5	10	3
	30	□	MNS0810-L30C	244.5	281.5	284.5	325.5	324	1.5	10	3
	5	★	MNS0810LB	42.0	69.5	73.5	128.5	127	1.5	9	3
	10	□	MNS0810X10DB	82.5	112.5	115.5	170.5	169	1.5	9	3
20	□	MNS0810X20DB	163.5	197.5	200.5	255.5	254	1.5	9	3	
30	□	MNS0810X30DB	244.5	282.5	285.5	340.5	339	1.5	9	3	

Примечание 1) Пожалуйста, свяжитесь с нами если Вы не нашли нужную геометрию в данном каталоге (могут быть заказаны другие диаметры и длины).

● : Есть на складе. ★ : Со склада в Японии.

□ : Нет на складе, выпускается исключительно под заказ.

DC (мм)	Глубина сверления (L/D)	TF15	Обозначение	Размеры (мм)							Тип
				LU	LCF	LH	OAL	LF	PL	DCON	
8.2	3	□	MNS0820S-DIN	34.2	46.5	47.5	88.5	87	1.5	10	4
	3	□	MNS0820S-DIN-C	34.2	46.5	47.5	88.5	87	1.5	10	3
	5	□	MNS0820L-DIN	48.2	60.5	61.5	102.5	101	1.5	10	4
	5	□	MNS0820L-DIN-C	48.2	60.5	61.5	102.5	101	1.5	10	3
	8	□	MNS0820-L8C	67.1	95.5	98.5	139.5	138	1.5	10	3
	5	★	MNS0820LB	42.5	69.5	73.5	128.5	127	1.5	9	3
	10	□	MNS0820X10DB	83.5	112.5	115.5	170.5	169	1.5	9	3
	20	□	MNS0820X20DB	165.5	197.5	200.5	255.5	254	1.5	9	3
30	□	MNS0820X30DB	247.5	282.5	285.5	340.5	339	1.5	9	3	
8.3	3	□	MNS0830S-DIN	34.1	46.5	47.5	88.5	87	1.5	10	4
	3	□	MNS0830S-DIN-C	34.1	46.5	47.5	88.5	87	1.5	10	3
	5	□	MNS0830L-DIN-C	48.1	60.5	61.5	102.5	101	1.5	10	3
	8	□	MNS0830-L8C	67.9	95.5	98.5	139.5	138	1.5	10	3
	10	□	MNS0830-L10C	84.5	112.5	115.5	156.5	155	1.5	10	3
	12	□	MNS0830-L12C	101.1	129.5	132.5	173.5	172	1.5	10	3
	15	□	MNS0830-L15C	126.0	154.5	157.5	198.5	197	1.5	10	3
	20	□	MNS0830-L20C	167.5	197.5	200.5	241.5	240	1.5	10	3
	25	□	MNS0830-L25C	209.0	239.5	242.5	283.5	282	1.5	10	3
	30	□	MNS0830-L30C	250.5	281.5	284.5	325.5	324	1.5	10	3
	5	★	MNS0830LB	43.0	69.5	73.5	128.5	127	1.5	9	3
	10	□	MNS0830X10DB	84.5	112.5	115.5	170.5	169	1.5	9	3
20	□	MNS0830X20DB	167.5	197.5	200.5	255.5	254	1.5	9	3	
30	□	MNS0830X30DB	250.5	282.5	285.5	340.5	339	1.5	9	3	
8.4	3	□	MNS0840S-DIN	33.9	46.5	47.5	88.5	87	1.5	10	4
	3	□	MNS0840S-DIN-C	33.9	46.5	47.5	88.5	87	1.5	10	3
	5	□	MNS0840L-DIN	47.9	60.5	61.5	102.5	101	1.5	10	4
	5	□	MNS0840L-DIN-C	47.9	60.5	61.5	102.5	101	1.5	10	3
	8	□	MNS0840-L8C	68.7	95.5	98.5	139.5	138	1.5	10	3
	10	□	MNS0840-L10C	85.5	112.5	115.5	156.5	155	1.5	10	3
	12	□	MNS0840-L12C	102.3	129.5	132.5	173.5	172	1.5	10	3
	15	□	MNS0840-L15C	127.5	154.5	157.5	198.5	197	1.5	10	3
	20	□	MNS0840-L20C	169.5	197.5	200.5	241.5	240	1.5	10	3
	25	□	MNS0840-L25C	211.5	239.5	242.5	283.5	282	1.5	10	3
	30	□	MNS0840-L30C	253.5	281.5	284.5	325.5	324	1.5	10	3
	5	★	MNS0840LB	43.5	69.5	73.5	128.5	127	1.5	9	3
10	□	MNS0840X10DB	85.5	112.5	115.5	170.5	169	1.5	9	3	
20	□	MNS0840X20DB	169.5	197.5	200.5	255.5	254	1.5	9	3	
30	□	MNS0840X30DB	253.5	282.5	285.5	340.5	339	1.5	9	3	

DC (мм)	Глубина сверления (L/D)	TF15	Обозначение	Размеры (мм)							Тип
				LU	LCF	LH	OAL	LF	PL	DCON	
8.5	3	□	MNS0850S-DIN	33.8	46.5	47.5	88.5	87	1.5	10	4
	3	□	MNS0850S-DIN-C	33.8	46.5	47.5	88.5	87	1.5	10	3
	5	□	MNS0850L-DIN	47.8	60.5	61.5	102.5	101	1.5	10	4
	5	●	MNS0850L-DIN-C	47.8	60.5	61.5	102.5	101	1.5	10	3
	8	□	MNS0850-L8C	69.5	95.5	98.5	139.5	138	1.5	10	3
	10	□	MNS0850-L10C	86.5	112.5	115.5	156.5	155	1.5	10	3
	12	●	MNS0850-L12C	103.5	129.5	132.5	173.5	172	1.5	10	3
	15	□	MNS0850-L15C	129.0	154.5	157.5	198.5	197	1.5	10	3
	20	●	MNS0850-L20C	171.5	197.5	200.5	241.5	240	1.5	10	3
	25	□	MNS0850-L25C	214.0	239.5	242.5	283.5	282	1.5	10	3
	30	●	MNS0850-L30C	256.5	281.5	284.5	325.5	324	1.5	10	3
	5	★	MNS0850LB	44.0	69.5	73.5	128.5	127	1.5	9	3
10	□	MNS0850X10DB	86.5	112.5	115.5	170.5	169	1.5	9	3	
20	□	MNS0850X20DB	171.5	197.5	200.5	255.5	254	1.5	9	3	
30	□	MNS0850X30DB	256.5	282.5	285.5	340.5	339	1.5	9	3	
8.6	3	□	MNS0860S-DIN	33.7	46.6	47.6	88.6	87	1.6	10	4
	3	□	MNS0860S-DIN-C	33.7	46.6	47.6	88.6	87	1.6	10	3
	5	□	MNS0860L-DIN-C	47.7	60.6	61.6	102.6	101	1.6	10	3
	8	□	MNS0860-L8C	70.4	100.6	103.6	144.6	143	1.6	10	3
	10	□	MNS0860-L10C	87.6	118.6	121.6	162.6	161	1.6	10	3
	12	□	MNS0860-L12C	104.8	136.6	139.6	180.6	179	1.6	10	3
	15	□	MNS0860-L15C	130.6	163.6	166.6	207.6	206	1.6	10	3
	20	□	MNS0860-L20C	173.6	208.6	211.6	252.6	251	1.6	10	3
	25	□	MNS0860-L25C	216.6	253.6	256.6	297.6	296	1.6	10	3
	30	□	MNS0860-L30C	259.6	297.6	300.6	341.6	340	1.6	10	3
	5	★	MNS0860LB	44.6	73.6	73.6	128.6	127	1.6	9	3
	10	□	MNS0860X10DB	87.6	118.6	121.6	176.6	175	1.6	9	3
20	□	MNS0860X20DB	173.6	208.6	211.6	266.6	265	1.6	9	3	
30	□	MNS0860X30DB	259.6	298.6	301.6	356.6	355	1.6	9	3	
8.7	3	□	MNS0870S-DIN	33.5	46.6	47.6	88.6	87	1.6	10	4
	3	□	MNS0870S-DIN-C	33.5	46.6	47.6	88.6	87	1.6	10	3
	5	□	MNS0870L-DIN	47.5	60.6	61.6	102.6	101	1.6	10	4
	5	□	MNS0870L-DIN-C	47.5	60.6	61.6	102.6	101	1.6	10	3
	8	□	MNS0870-L8C	71.2	100.6	103.6	144.6	143	1.6	10	3
	10	□	MNS0870-L10C	88.6	118.6	121.6	162.6	161	1.6	10	3
	12	□	MNS0870-L12C	106.0	136.6	139.6	180.6	179	1.6	10	3
	15	□	MNS0870-L15C	132.1	163.6	166.6	207.6	206	1.6	10	3
	20	□	MNS0870-L20C	175.6	208.6	211.6	252.6	251	1.6	10	3
	25	□	MNS0870-L25C	219.1	253.6	256.6	297.6	296	1.6	10	3
	30	□	MNS0870-L30C	262.6	297.6	300.6	341.6	340	1.6	10	3
	5	★	MNS0870LB	45.1	73.6	73.6	128.6	127	1.6	9	3
10	□	MNS0870X10DB	88.6	118.6	121.6	176.6	175	1.6	9	3	
20	□	MNS0870X20DB	175.6	208.6	211.6	266.6	265	1.6	9	3	
30	□	MNS0870X30DB	262.6	298.6	301.6	356.6	355	1.6	9	3	

DC (мм)	Глубина сверления (L/D)	TF15	Обозначение	Размеры (мм)							Тип
				LU	LCF	LH	OAL	LF	PL	DCON	
8.8	3	□	MNS0880S-DIN	33.4	46.6	47.6	88.6	87	1.6	10	4
	3	□	MNS0880S-DIN-C	33.4	46.6	47.6	88.6	87	1.6	10	3
	5	□	MNS0880L-DIN	47.4	60.6	61.6	102.6	101	1.6	10	4
	5	□	MNS0880L-DIN-C	47.4	60.6	61.6	102.6	101	1.6	10	3
	8	□	MNS0880-L8C	72.0	100.6	103.6	144.6	143	1.6	10	3
	10	□	MNS0880-L10C	89.6	118.6	121.6	162.6	161	1.6	10	3
	12	□	MNS0880-L12C	107.2	136.6	139.6	180.6	179	1.6	10	3
	15	□	MNS0880-L15C	133.6	163.6	166.6	207.6	206	1.6	10	3
	20	□	MNS0880-L20C	177.6	208.6	211.6	252.6	251	1.6	10	3
	25	□	MNS0880-L25C	221.6	253.6	256.6	297.6	296	1.6	10	3
	30	□	MNS0880-L30C	265.6	297.6	300.6	341.6	340	1.6	10	3
	5	★	MNS0880LB	45.6	73.6	73.6	128.6	127	1.6	9	3
	10	□	MNS0880X10DB	89.6	118.6	121.6	176.6	175	1.6	9	3
	20	□	MNS0880X20DB	177.6	208.6	211.6	266.6	265	1.6	9	3
30	□	MNS0880X30DB	265.6	298.6	301.6	356.6	355	1.6	9	3	
8.9	3	□	MNS0890S-DIN	33.3	46.6	47.6	88.6	87	1.6	10	4
	3	□	MNS0890S-DIN-C	33.3	46.6	47.6	88.6	87	1.6	10	3
	5	□	MNS0890L-DIN	47.3	60.6	61.6	102.6	101	1.6	10	4
	5	□	MNS0890L-DIN-C	47.3	60.6	61.6	102.6	101	1.6	10	3
	8	□	MNS0890-L8C	72.8	100.6	103.6	144.6	143	1.6	10	3
	10	□	MNS0890-L10C	90.6	118.6	121.6	162.6	161	1.6	10	3
	12	□	MNS0890-L12C	108.4	136.6	139.6	180.6	179	1.6	10	3
	15	□	MNS0890-L15C	135.1	163.6	166.6	207.6	206	1.6	10	3
	20	□	MNS0890-L20C	179.6	208.6	211.6	252.6	251	1.6	10	3
	25	□	MNS0890-L25C	224.1	253.6	256.6	297.6	296	1.6	10	3
	30	□	MNS0890-L30C	268.6	297.6	300.6	341.6	340	1.6	10	3
	5	★	MNS0890LB	46.1	73.6	73.6	128.6	127	1.6	9	3
	10	□	MNS0890X10DB	90.6	118.6	121.6	176.6	175	1.6	9	3
	20	□	MNS0890X20DB	179.6	208.6	211.6	266.6	265	1.6	9	3
30	□	MNS0890X30DB	268.6	298.6	301.6	356.6	355	1.6	9	3	
9.0	3	□	MNS0900S-DIN	33.1	46.6	47.6	88.6	87	1.6	10	4
	3	□	MNS0900S-DIN-C	33.1	46.6	47.6	88.6	87	1.6	10	3
	5	□	MNS0900L-DIN	47.1	60.6	61.6	102.6	101	1.6	10	4
	5	●	MNS0900L-DIN-C	47.1	60.6	61.6	102.6	101	1.6	10	3
	8	□	MNS0900-L8C	73.6	100.6	103.6	144.6	143	1.6	10	3
	10	□	MNS0900-L10C	91.6	118.6	121.6	162.6	161	1.6	10	3
	12	●	MNS0900-L12C	109.6	136.6	139.6	180.6	179	1.6	10	3
	15	□	MNS0900-L15C	136.6	163.6	166.6	207.6	206	1.6	10	3
	20	●	MNS0900-L20C	181.6	208.6	211.6	252.6	251	1.6	10	3
	25	□	MNS0900-L25C	226.6	253.6	256.6	297.6	296	1.6	10	3
	30	●	MNS0900-L30C	271.6	297.6	300.6	341.6	340	1.6	10	3
	5	★	MNS0900LB	46.6	73.6	73.6	128.6	127	1.6	9	3
	10	★	MNS0900X10DB	91.6	118.6	121.6	176.6	175	1.6	9	3
	20	★	MNS0900X20DB	181.6	208.6	211.6	266.6	265	1.6	9	3
30	★	MNS0900X30DB	271.6	298.6	301.6	356.6	355	1.6	9	3	

DC (мм)	Глубина сверления (L/D)	TF15	Обозначение	Размеры (мм)							Тип
				LU	LCF	LH	OAL	LF	PL	DCON	
9.1	3	□	MNS0910S-DIN	33.0	46.7	47.7	88.7	87	1.7	10	4
	3	□	MNS0910S-DIN-C	33.0	46.7	47.7	88.7	87	1.7	10	3
	5	□	MNS0910L-DIN	47.0	60.7	61.7	102.7	101	1.7	10	4
	5	□	MNS0910L-DIN-C	47.0	60.7	61.7	102.7	101	1.7	10	3
	8	□	MNS0910-L8C	74.5	106.7	109.7	150.7	149	1.7	10	3
	10	□	MNS0910-L10C	92.7	125.7	128.7	169.7	168	1.7	10	3
	12	□	MNS0910-L12C	110.9	144.7	147.7	188.7	187	1.7	10	3
	15	□	MNS0910-L15C	138.2	172.7	175.7	216.7	215	1.7	10	3
	20	□	MNS0910-L20C	183.7	220.7	223.7	264.7	263	1.7	10	3
	25	□	MNS0910-L25C	229.2	267.7	270.7	311.7	310	1.7	10	3
	30	□	MNS0910-L30C	274.7	315.7	318.7	359.7	358	1.7	10	3
	5	★	MNS0910LB	47.2	77.7	81.7	137.7	136	1.7	10	3
	10	□	MNS0910X10DB	92.7	125.7	128.7	183.7	182	1.7	10	3
	20	□	MNS0910X20DB	183.7	220.7	223.7	278.7	277	1.7	10	3
30	□	MNS0910X30DB	274.7	315.7	318.7	373.7	372	1.7	10	3	
9.2	3	□	MNS0920S-DIN	32.9	46.7	47.7	88.7	87	1.7	10	4
	3	□	MNS0920S-DIN-C	32.9	46.7	47.7	88.7	87	1.7	10	3
	5	□	MNS0920L-DIN	46.9	60.7	61.7	102.7	101	1.7	10	4
	5	□	MNS0920L-DIN-C	46.9	60.7	61.7	102.7	101	1.7	10	3
	8	□	MNS0920-L8C	75.3	106.7	109.7	150.7	149	1.7	10	3
	10	□	MNS0920-L10C	93.7	125.7	128.7	169.7	168	1.7	10	3
	12	□	MNS0920-L12C	112.1	144.7	147.7	188.7	187	1.7	10	3
	15	□	MNS0920-L15C	139.7	172.7	175.7	216.7	215	1.7	10	3
	20	□	MNS0920-L20C	185.7	220.7	223.7	264.7	263	1.7	10	3
	25	□	MNS0920-L25C	231.7	267.7	270.7	311.7	310	1.7	10	3
	30	□	MNS0920-L30C	277.7	315.7	318.7	359.7	358	1.7	10	3
	5	★	MNS0920LB	47.7	77.7	81.7	137.7	136	1.7	10	3
	10	□	MNS0920X10DB	93.7	125.7	128.7	183.7	182	1.7	10	3
	20	□	MNS0920X20DB	185.7	220.7	223.7	278.7	277	1.7	10	3
30	□	MNS0920X30DB	277.7	315.7	318.7	373.7	372	1.7	10	3	
9.3	3	□	MNS0930S-DIN	32.7	46.7	47.7	88.7	87	1.7	10	4
	3	□	MNS0930S-DIN-C	32.7	46.7	47.7	88.7	87	1.7	10	3
	5	□	MNS0930L-DIN	46.7	60.7	61.7	102.7	101	1.7	10	4
	5	□	MNS0930L-DIN-C	46.7	60.7	61.7	102.7	101	1.7	10	3
	8	□	MNS0930-L8C	76.1	106.7	109.7	150.7	149	1.7	10	3
	10	□	MNS0930-L10C	94.7	125.7	128.7	169.7	168	1.7	10	3
	12	□	MNS0930-L12C	113.3	144.7	147.7	188.7	187	1.7	10	3
	15	□	MNS0930-L15C	141.2	172.7	175.7	216.7	215	1.7	10	3
	20	□	MNS0930-L20C	187.7	220.7	223.7	264.7	263	1.7	10	3
	25	□	MNS0930-L25C	234.2	267.7	270.7	311.7	310	1.7	10	3
	30	□	MNS0930-L30C	280.7	315.7	318.7	359.7	358	1.7	10	3
	5	★	MNS0930LB	48.2	77.7	81.7	137.7	136	1.7	10	3
	10	□	MNS0930X10DB	94.7	125.7	128.7	183.7	182	1.7	10	3
	20	□	MNS0930X20DB	187.7	220.7	223.7	278.7	277	1.7	10	3
30	□	MNS0930X30DB	280.7	315.7	318.7	373.7	372	1.7	10	3	

Примечание 1) Пожалуйста, свяжитесь с нами если Вы не нашли нужную геометрию в данном каталоге (могут быть заказаны другие диаметры и длины).

● : Есть на складе. ★ : Со склада в Японии.

□ : Нет на складе, выпускается исключительно под заказ.

DC (мм)	Глубина сверления (L/D)	TF15	Обозначение	Размеры (мм)							Тип
				LU	LCF	LH	OAL	LF	PL	DCON	
9.4	3	□	MNS0940S-DIN	32.6	46.7	47.7	88.7	87	1.7	10	4
	3	□	MNS0940S-DIN-C	32.6	46.7	47.7	88.7	87	1.7	10	3
	5	□	MNS0940L-DIN	46.6	60.7	61.7	102.7	101	1.7	10	4
	5	□	MNS0940L-DIN-C	46.6	60.7	61.7	102.7	101	1.7	10	3
	8	□	MNS0940-L8C	76.9	106.7	109.7	150.7	149	1.7	10	3
	10	□	MNS0940-L10C	95.7	125.7	128.7	169.7	168	1.7	10	3
	12	□	MNS0940-L12C	114.5	144.7	147.7	188.7	187	1.7	10	3
	15	□	MNS0940-L15C	142.7	172.7	175.7	216.7	215	1.7	10	3
	20	□	MNS0940-L20C	189.7	220.7	223.7	264.7	263	1.7	10	3
	25	□	MNS0940-L25C	236.7	267.7	270.7	311.7	310	1.7	10	3
	30	□	MNS0940-L30C	283.7	315.7	318.7	359.7	358	1.7	10	3
	5	★	MNS0940LB	48.7	77.7	81.7	137.7	136	1.7	10	3
	10	□	MNS0940X10DB	95.7	125.7	128.7	183.7	182	1.7	10	3
	20	□	MNS0940X20DB	189.7	220.7	223.7	278.7	277	1.7	10	3
30	□	MNS0940X30DB	283.7	315.7	318.7	373.7	372	1.7	10	3	
9.5	3	□	MNS0950S-DIN	32.5	46.7	47.7	88.7	87	1.7	10	4
	3	□	MNS0950S-DIN-C	32.5	46.7	47.7	88.7	87	1.7	10	3
	5	□	MNS0950L-DIN	46.5	60.7	61.7	102.7	101	1.7	10	4
	5	●	MNS0950L-DIN-C	46.5	60.7	61.7	102.7	101	1.7	10	3
	8	□	MNS0950-L8C	77.7	106.7	109.7	150.7	149	1.7	10	3
	10	□	MNS0950-L10C	96.7	125.7	128.7	169.7	168	1.7	10	3
	12	●	MNS0950-L12C	115.7	144.7	147.7	188.7	187	1.7	10	3
	15	□	MNS0950-L15C	144.2	172.7	175.7	216.7	215	1.7	10	3
	20	●	MNS0950-L20C	191.7	220.7	223.7	264.7	263	1.7	10	3
	25	□	MNS0950-L25C	239.2	267.7	270.7	311.7	310	1.7	10	3
	30	●	MNS0950-L30C	286.7	315.7	318.7	359.7	358	1.7	10	3
	5	★	MNS0950LB	49.2	77.7	81.7	137.7	136	1.7	10	3
	10	□	MNS0950X10DB	96.7	125.7	128.7	183.7	182	1.7	10	3
	20	□	MNS0950X20DB	191.7	220.7	223.7	278.7	277	1.7	10	3
30	□	MNS0950X30DB	286.7	315.7	318.7	373.7	372	1.7	10	3	
9.6	3	□	MNS0960S-DIN	32.3	46.7	47.7	88.7	87	1.7	10	4
	3	□	MNS0960S-DIN-C	32.3	46.7	47.7	88.7	87	1.7	10	3
	5	□	MNS0960L-DIN	46.3	60.7	61.7	102.7	101	1.7	10	4
	5	□	MNS0960L-DIN-C	46.3	60.7	61.7	102.7	101	1.7	10	3
	8	□	MNS0960-L8C	78.5	111.7	114.7	155.7	154	1.7	10	3
	10	□	MNS0960-L10C	97.7	131.7	134.7	175.7	174	1.7	10	3
	12	□	MNS0960-L12C	116.9	151.7	154.7	195.7	194	1.7	10	3
	15	□	MNS0960-L15C	145.7	181.7	184.7	225.7	224	1.7	10	3
	20	□	MNS0960-L20C	193.7	231.7	234.7	275.7	274	1.7	10	3
	25	□	MNS0960-L25C	241.7	281.7	284.7	325.7	324	1.7	10	3
	30	□	MNS0960-L30C	289.7	331.7	334.7	375.7	374	1.7	10	3
	5	★	MNS0960LB	49.7	81.7	81.7	137.7	136	1.7	10	3
	10	□	MNS0960X10DB	97.7	131.7	134.7	189.7	188	1.7	10	3
	20	□	MNS0960X20DB	193.7	231.7	234.7	289.7	288	1.7	10	3
30	□	MNS0960X30DB	289.7	331.7	334.7	389.7	388	1.7	10	3	

DC (мм)	Глубина сверления (L/D)	TF15	Обозначение	Размеры (мм)							Тип
				LU	LCF	LH	OAL	LF	PL	DCON	
9.7	3	□	MNS0970S-DIN	32.2	46.8	47.8	88.8	87	1.8	10	4
	3	□	MNS0970S-DIN-C	32.2	46.8	47.8	88.8	87	1.8	10	3
	5	□	MNS0970L-DIN	46.2	60.8	61.8	102.8	101	1.8	10	4
	5	□	MNS0970L-DIN-C	46.2	60.8	61.8	102.8	101	1.8	10	3
	8	□	MNS0970-L8C	79.4	111.8	114.8	155.8	154	1.8	10	3
	10	□	MNS0970-L10C	98.8	131.8	134.8	175.8	174	1.8	10	3
	12	□	MNS0970-L12C	118.2	151.8	154.8	195.8	194	1.8	10	3
	15	□	MNS0970-L15C	147.3	181.8	184.8	225.8	224	1.8	10	3
	20	□	MNS0970-L20C	195.8	231.8	234.8	275.8	274	1.8	10	3
	25	□	MNS0970-L25C	244.3	281.8	284.8	325.8	324	1.8	10	3
	30	□	MNS0970-L30C	292.8	331.8	334.8	375.8	374	1.8	10	3
	5	★	MNS0970LB	50.3	81.8	81.8	137.8	136	1.8	10	3
	10	□	MNS0970X10DB	98.8	131.8	134.8	189.8	188	1.8	10	3
	20	□	MNS0970X20DB	195.8	231.8	234.8	289.8	288	1.8	10	3
30	□	MNS0970X30DB	292.8	331.8	334.8	389.8	388	1.8	10	3	
9.8	3	□	MNS0980S-DIN	32.1	46.8	47.8	88.8	87	1.8	10	4
	3	□	MNS0980S-DIN-C	32.1	46.8	47.8	88.8	87	1.8	10	3
	5	□	MNS0980L-DIN	46.1	60.8	61.8	102.8	101	1.8	10	4
	5	□	MNS0980L-DIN-C	46.1	60.8	61.8	102.8	101	1.8	10	3
	8	□	MNS0980-L8C	80.2	111.8	114.8	155.8	154	1.8	10	3
	10	□	MNS0980-L10C	99.8	131.8	134.8	175.8	174	1.8	10	3
	12	□	MNS0980-L12C	119.4	151.8	154.8	195.8	194	1.8	10	3
	15	□	MNS0980-L15C	148.8	181.8	184.8	225.8	224	1.8	10	3
	20	□	MNS0980-L20C	197.8	231.8	234.8	275.8	274	1.8	10	3
	25	□	MNS0980-L25C	246.8	281.8	284.8	325.8	324	1.8	10	3
	30	□	MNS0980-L30C	295.8	331.8	334.8	375.8	374	1.8	10	3
	5	★	MNS0980LB	50.8	81.8	81.8	137.8	136	1.8	10	3
	10	★	MNS0980X10DB	99.8	131.8	134.8	189.8	188	1.8	10	3
	20	★	MNS0980X20DB	197.8	231.8	234.8	289.8	288	1.8	10	3
30	★	MNS0980X30DB	295.8	331.8	334.8	389.8	388	1.8	10	3	
9.9	3	□	MNS0990S-DIN	32.0	46.8	47.8	88.8	87	1.8	10	4
	3	□	MNS0990S-DIN-C	32.0	46.8	47.8	88.8	87	1.8	10	3
	5	□	MNS0990L-DIN	46.0	60.8	61.8	102.8	101	1.8	10	4
	5	□	MNS0990L-DIN-C	46.0	60.8	61.8	102.8	101	1.8	10	3
	8	□	MNS0990-L8C	81.0	111.8	114.8	155.8	154	1.8	10	3
	10	□	MNS0990-L10C	100.8	131.8	134.8	175.8	174	1.8	10	3
	12	□	MNS0990-L12C	120.6	151.8	154.8	195.8	194	1.8	10	3
	15	□	MNS0990-L15C	150.3	181.8	184.8	225.8	224	1.8	10	3
	20	□	MNS0990-L20C	199.8	231.8	234.8	275.8	274	1.8	10	3
	25	□	MNS0990-L25C	249.3	281.8	284.8	325.8	324	1.8	10	3
	30	□	MNS0990-L30C	298.8	331.8	334.8	375.8	374	1.8	10	3
	5	★	MNS0990LB	51.3	81.8	81.8	137.8	136	1.8	10	3
	10	□	MNS0990X10DB	100.8	131.8	134.8	189.8	188	1.8	10	3
	20	□	MNS0990X20DB	199.8	231.8	234.8	289.8	288	1.8	10	3
30	□	MNS0990X30DB	298.8	331.8	334.8	389.8	388	1.8	10	3	

М
ИНСТРУМЕНТ ДЛЯ
СВЕРЛЕНИЯ

MNS

ТВЕРДЫЙ
СПЛАВ

М
ИНСТРУМЕНТ ДЛЯ
СВЕРЛЕНИЯ

DC (мм)	Глубина сверления (L/D)	TF15	Обозначение	Размеры (мм)							Тип
				LU	LCF	LH	OAL	LF	PL	DCON	
10.0	3	□	MNS1000S-DIN	31.8	46.8	47.8	88.8	87	1.8	10	4
	3	□	MNS1000S-DIN-C	31.8	46.8	47.8	88.8	87	1.8	10	3
	5	□	MNS1000L-DIN	45.8	60.8	61.8	102.8	101	1.8	10	4
	5	●	MNS1000L-DIN-C	45.8	60.8	61.8	102.8	101	1.8	10	3
	8	□	MNS1000-L8C	81.8	111.8	114.8	155.8	154	1.8	10	3
	10	□	MNS1000-L10C	101.8	131.8	134.8	175.8	174	1.8	10	3
	12	●	MNS1000-L12C	121.8	151.8	154.8	195.8	194	1.8	10	3
	15	□	MNS1000-L15C	151.8	181.8	184.8	225.8	224	1.8	10	3
	20	●	MNS1000-L20C	201.8	231.8	234.8	275.8	274	1.8	10	3
	25	□	MNS1000-L25C	251.8	281.8	284.8	325.8	324	1.8	10	3
	30	●	MNS1000-L30C	301.8	331.8	334.8	375.8	374	1.8	10	3
	5	★	MNS1000LB	51.8	81.8	81.8	137.8	136	1.8	10	3
	10	★	MNS1000X10DB	101.8	131.8	134.8	189.8	188	1.8	10	3
	20	★	MNS1000X20DB	201.8	231.8	234.8	289.8	288	1.8	10	3
30	★	MNS1000X30DB	301.8	331.8	334.8	389.8	388	1.8	10	3	
10.1	3	□	MNS1010S-DIN	39.7	54.8	55.8	101.8	100	1.8	12	4
	3	□	MNS1010S-DIN-C	39.7	54.8	55.8	101.8	100	1.8	12	3
	5	□	MNS1010L-DIN	55.7	70.8	71.8	117.8	116	1.8	12	4
	5	□	MNS1010L-DIN-C	55.7	70.8	71.8	117.8	116	1.8	12	3
	8	□	MNS1010-L8C	82.6	117.8	120.8	166.8	165	1.8	12	3
	10	□	MNS1010-L10C	102.8	138.8	141.8	187.8	186	1.8	12	3
	12	□	MNS1010-L12C	123.0	159.8	162.8	208.8	207	1.8	12	3
	15	□	MNS1010-L15C	153.3	190.8	193.8	239.8	238	1.8	12	3
	20	□	MNS1010-L20C	203.8	243.8	246.8	292.8	291	1.8	12	3
	25	□	MNS1010-L25C	254.3	295.8	298.8	344.8	343	1.8	12	3
	5	★	MNS1010LB	52.3	85.8	89.8	150.8	149	1.8	11	3
	10	□	MNS1010X10DB	102.8	138.8	141.8	202.8	201	1.8	11	3
	20	□	MNS1010X20DB	203.8	243.8	246.8	307.8	306	1.8	11	3
	10.2	3	□	MNS1020S-DIN	39.6	54.9	55.9	101.9	100	1.9	12
3		□	MNS1020S-DIN-C	39.6	54.9	55.9	101.9	100	1.9	12	3
5		□	MNS1020L-DIN	55.6	70.9	71.9	117.9	116	1.9	12	4
5		□	MNS1020L-DIN-C	55.6	70.9	71.9	117.9	116	1.9	12	3
8		□	MNS1020-L8C	83.5	117.9	120.9	166.9	165	1.9	12	3
10		□	MNS1020-L10C	103.9	138.9	141.9	187.9	186	1.9	12	3
12		□	MNS1020-L12C	124.3	159.9	162.9	208.9	207	1.9	12	3
15		□	MNS1020-L15C	154.9	190.9	193.9	239.9	238	1.9	12	3
20		□	MNS1020-L20C	205.9	243.9	246.9	292.9	291	1.9	12	3
25		□	MNS1020-L25C	256.9	295.9	298.9	344.9	343	1.9	12	3
5		★	MNS1020LB	52.9	85.9	89.9	150.9	149	1.9	11	3
10		□	MNS1020X10DB	103.9	138.9	141.9	202.9	201	1.9	11	3
20		□	MNS1020X20DB	205.9	243.9	246.9	307.9	306	1.9	11	3
10.3		3	□	MNS1030S-DIN	39.4	54.9	55.9	101.9	100	1.9	12
	3	□	MNS1030S-DIN-C	39.4	54.9	55.9	101.9	100	1.9	12	3
	5	□	MNS1030L-DIN	55.4	70.9	71.9	117.9	116	1.9	12	4
	5	□	MNS1030L-DIN-C	55.4	70.9	71.9	117.9	116	1.9	12	3
	8	□	MNS1030-L8C	84.3	117.9	120.9	166.9	165	1.9	12	3
	10	□	MNS1030-L10C	104.9	138.9	141.9	187.9	186	1.9	12	3
	12	□	MNS1030-L12C	125.5	159.9	162.9	208.9	207	1.9	12	3

DC (мм)	Глубина сверления (L/D)	TF15	Обозначение	Размеры (мм)							Тип
				LU	LCF	LH	OAL	LF	PL	DCON	
10.3	15	□	MNS1030-L15C	156.4	190.9	193.9	239.9	238	1.9	12	3
	20	□	MNS1030-L20C	207.9	243.9	246.9	292.9	291	1.9	12	3
	25	□	MNS1030-L25C	259.4	295.9	298.9	344.9	343	1.9	12	3
	5	★	MNS1030LB	53.4	85.9	89.9	150.9	149	1.9	11	3
	10	□	MNS1030X10DB	104.9	138.9	141.9	202.9	201	1.9	11	3
	20	□	MNS1030X20DB	207.9	243.9	246.9	307.9	306	1.9	11	3
10.4	3	□	MNS1040S-DIN	39.3	54.9	55.9	101.9	100	1.9	12	4
	3	□	MNS1040S-DIN-C	39.3	54.9	55.9	101.9	100	1.9	12	3
	5	□	MNS1040L-DIN	55.3	70.9	71.9	117.9	116	1.9	12	4
	5	□	MNS1040L-DIN-C	55.3	70.9	71.9	117.9	116	1.9	12	3
	8	□	MNS1040-L8C	85.1	117.9	120.9	166.9	165	1.9	12	3
	10	□	MNS1040-L10C	105.9	138.9	141.9	187.9	186	1.9	12	3
	12	□	MNS1040-L12C	126.7	159.9	162.9	208.9	207	1.9	12	3
	15	□	MNS1040-L15C	157.9	190.9	193.9	239.9	238	1.9	12	3
	20	□	MNS1040-L20C	209.9	243.9	246.9	292.9	291	1.9	12	3
	25	□	MNS1040-L25C	261.9	295.9	298.9	344.9	343	1.9	12	3
5	★	MNS1040LB	53.9	85.9	89.9	150.9	149	1.9	11	3	
10	□	MNS1040X10DB	105.9	138.9	141.9	202.9	201	1.9	11	3	
20	□	MNS1040X20DB	209.9	243.9	246.9	307.9	306	1.9	11	3	
10.5	3	□	MNS1050S-DIN	39.2	54.9	55.9	101.9	100	1.9	12	4
	3	□	MNS1050S-DIN-C	39.2	54.9	55.9	101.9	100	1.9	12	3
	5	□	MNS1050L-DIN	55.2	70.9	71.9	117.9	116	1.9	12	4
	5	●	MNS1050L-DIN-C	55.2	70.9	71.9	117.9	116	1.9	12	3
	8	□	MNS1050-L8C	85.9	117.9	120.9	166.9	165	1.9	12	3
	10	□	MNS1050-L10C	106.9	138.9	141.9	187.9	186	1.9	12	3
	12	●	MNS1050-L12C	127.9	159.9	162.9	208.9	207	1.9	12	3
	15	□	MNS1050-L15C	159.4	190.9	193.9	239.9	238	1.9	12	3
	20	●	MNS1050-L20C	211.9	243.9	246.9	292.9	291	1.9	12	3
	25	□	MNS1050-L25C	264.4	295.9	298.9	344.9	343	1.9	12	3
5	★	MNS1050LB	54.4	85.9	89.9	150.9	149	1.9	11	3	
10	★	MNS1050X10DB	106.9	138.9	141.9	202.9	201	1.9	11	3	
20	★	MNS1050X20DB	211.9	243.9	246.9	307.9	306	1.9	11	3	
10.6	3	□	MNS1060S-DIN	39.0	54.9	55.9	101.9	100	1.9	12	4
	3	□	MNS1060S-DIN-C	39.0	54.9	55.9	101.9	100	1.9	12	3
	5	□	MNS1060L-DIN	55.0	70.9	71.9	117.9	116	1.9	12	4
	5	□	MNS1060L-DIN-C	55.0	70.9	71.9	117.9	116	1.9	12	3
	8	□	MNS1060-L8C	86.7	122.9	125.9	171.9	170	1.9	12	3
	10	□	MNS1060-L10C	107.9	144.9	147.9	193.9	192	1.9	12	3
	12	□	MNS1060-L12C	129.1	166.9	169.9	215.9	214	1.9	12	3
	15	□	MNS1060-L15C	160.9	199.9	202.9	248.9	247	1.9	12	3
	20	□	MNS1060-L20C	213.9	254.9	257.9	303.9	302	1.9	12	3
	25	□	MNS1060-L25C	266.9	309.9	312.9	358.9	357	1.9	12	3
5	★	MNS1060LB	54.9	89.9	89.9	150.9	149	1.9	11	3	
10	□	MNS1060X10DB	107.9	144.9	147.9	208.9	207	1.9	11	3	
20	□	MNS1060X20DB	213.9	254.9	257.9	318.9	317	1.9	11	3	

Примечание 1) Пожалуйста, свяжитесь с нами если Вы не нашли нужную геометрию в данном каталоге (могут быть заказаны другие диаметры и длины).

● : Есть на складе. ★ : Со склада в Японии.

□ : Нет на складе, выпускается исключительно под заказ.

DC (мм)	Глубина сверления (L/D)	TF15	Обозначение	Размеры (мм)							Тип
				LU	LCF	LH	OAL	LF	PL	DCON	
10.7	3	□	MNS1070S-DIN	38.9	54.9	55.9	101.9	100	1.9	12	4
	3	□	MNS1070S-DIN-C	38.9	54.9	55.9	101.9	100	1.9	12	3
	5	□	MNS1070L-DIN	54.9	70.9	71.9	117.9	116	1.9	12	4
	5	□	MNS1070L-DIN-C	54.9	70.9	71.9	117.9	116	1.9	12	3
	8	□	MNS1070-L8C	87.5	122.9	125.9	171.9	170	1.9	12	3
	10	□	MNS1070-L10C	108.9	144.9	147.9	193.9	192	1.9	12	3
	12	□	MNS1070-L12C	130.3	166.9	169.9	215.9	214	1.9	12	3
	15	□	MNS1070-L15C	162.4	199.9	202.9	248.9	247	1.9	12	3
	20	□	MNS1070-L20C	215.9	254.9	257.9	303.9	302	1.9	12	3
	25	□	MNS1070-L25C	269.4	309.9	312.9	358.9	357	1.9	12	3
	5	★	MNS1070LB	55.4	89.9	89.9	150.9	149	1.9	11	3
	10	□	MNS1070X10DB	108.9	144.9	147.9	208.9	207	1.9	11	3
20	□	MNS1070X20DB	215.9	254.9	257.9	318.9	317	1.9	11	3	
10.8	3	□	MNS1080S-DIN	38.8	55.0	56.0	102.0	100	2.0	12	4
	3	□	MNS1080S-DIN-C	38.8	55.0	56.0	102.0	100	2.0	12	3
	5	□	MNS1080L-DIN	54.8	71.0	72.0	118.0	116	2.0	12	4
	5	□	MNS1080L-DIN-C	54.8	71.0	72.0	118.0	116	2.0	12	3
	8	□	MNS1080-L8C	88.4	123.0	126.0	172.0	170	2.0	12	3
	10	□	MNS1080-L10C	110.0	145.0	148.0	194.0	192	2.0	12	3
	12	□	MNS1080-L12C	131.6	167.0	170.0	216.0	214	2.0	12	3
	15	□	MNS1080-L15C	164.0	200.0	203.0	249.0	247	2.0	12	3
	20	□	MNS1080-L20C	218.0	255.0	258.0	304.0	302	2.0	12	3
	25	□	MNS1080-L25C	272.0	310.0	313.0	359.0	357	2.0	12	3
	5	★	MNS1080LB	56.0	90.0	90.0	151.0	149	2.0	11	3
	10	□	MNS1080X10DB	110.0	145.0	148.0	209.0	207	2.0	11	3
20	□	MNS1080X20DB	218.0	255.0	258.0	319.0	317	2.0	11	3	
10.9	3	□	MNS1090S-DIN	38.6	55.0	56.0	102.0	100	2.0	12	4
	3	□	MNS1090S-DIN-C	38.6	55.0	56.0	102.0	100	2.0	12	3
	5	□	MNS1090L-DIN	54.6	71.0	72.0	118.0	116	2.0	12	4
	5	□	MNS1090L-DIN-C	54.6	71.0	72.0	118.0	116	2.0	12	3
	8	□	MNS1090-L8C	89.2	123.0	126.0	172.0	170	2.0	12	3
	10	□	MNS1090-L10C	111.0	145.0	148.0	194.0	192	2.0	12	3
	12	□	MNS1090-L12C	132.8	167.0	170.0	216.0	214	2.0	12	3
	15	□	MNS1090-L15C	165.5	200.0	203.0	249.0	247	2.0	12	3
	20	□	MNS1090-L20C	220.0	255.0	258.0	304.0	302	2.0	12	3
	25	□	MNS1090-L25C	274.5	310.0	313.0	359.0	357	2.0	12	3
	5	★	MNS1090LB	56.5	90.0	90.0	151.0	149	2.0	11	3
	10	□	MNS1090X10DB	111.0	145.0	148.0	209.0	207	2.0	11	3
20	□	MNS1090X20DB	220.0	255.0	258.0	319.0	317	2.0	11	3	
11.0	3	□	MNS1100S-DIN	38.5	55.0	56.0	102.0	100	2.0	12	4
	3	□	MNS1100S-DIN-C	38.5	55.0	56.0	102.0	100	2.0	12	3
	5	□	MNS1100L-DIN	54.5	71.0	72.0	118.0	116	2.0	12	4
	5	●	MNS1100L-DIN-C	54.5	71.0	72.0	118.0	116	2.0	12	3
	8	□	MNS1100-L8C	90.0	123.0	126.0	172.0	170	2.0	12	3
	10	□	MNS1100-L10C	112.0	145.0	148.0	194.0	192	2.0	12	3
	12	●	MNS1100-L12C	134.0	167.0	170.0	216.0	214	2.0	12	3

DC (мм)	Глубина сверления (L/D)	TF15	Обозначение	Размеры (мм)							Тип
				LU	LCF	LH	OAL	LF	PL	DCON	
11.0	15	□	MNS1100-L15C	167.0	200.0	203.0	249.0	247	2.0	12	3
	20	●	MNS1100-L20C	222.0	255.0	258.0	304.0	302	2.0	12	3
	25	□	MNS1100-L25C	277.0	310.0	313.0	359.0	357	2.0	12	3
	5	★	MNS1100LB	57.0	90.0	90.0	151.0	149	2.0	11	3
	10	★	MNS1100X10DB	112.0	145.0	148.0	209.0	207	2.0	11	3
	20	★	MNS1100X20DB	222.0	255.0	258.0	319.0	317	2.0	11	3
	11.1	3	□	MNS1110S-DIN	38.4	55.0	56.0	102.0	100	2.0	12
3		□	MNS1110S-DIN-C	38.4	55.0	56.0	102.0	100	2.0	12	3
5		□	MNS1110L-DIN	54.4	71.0	72.0	118.0	116	2.0	12	4
5		□	MNS1110L-DIN-C	54.4	71.0	72.0	118.0	116	2.0	12	3
8		□	MNS1110-L8C	90.8	129.0	132.0	178.0	176	2.0	12	3
10		□	MNS1110-L10C	113.0	152.0	155.0	201.0	199	2.0	12	3
12		□	MNS1110-L12C	135.2	175.0	178.0	224.0	222	2.0	12	3
15		□	MNS1110-L15C	168.5	209.0	212.0	258.0	256	2.0	12	3
20		□	MNS1110-L20C	224.0	267.0	270.0	316.0	314	2.0	12	3
25		□	MNS1110-L25C	279.5	324.0	327.0	373.0	371	2.0	12	3
5		★	MNS1110LB	57.5	94.0	98.0	160.0	158	2.0	12	3
10		□	MNS1110X10DB	113.0	152.0	155.0	217.0	215	2.0	12	3
20	□	MNS1110X20DB	224.0	267.0	270.0	332.0	330	2.0	12	3	
11.2	3	□	MNS1120S-DIN	38.2	55.0	56.0	102.0	100	2.0	12	4
	3	□	MNS1120S-DIN-C	38.2	55.0	56.0	102.0	100	2.0	12	3
	5	□	MNS1120L-DIN	54.2	71.0	72.0	118.0	116	2.0	12	4
	5	□	MNS1120L-DIN-C	54.2	71.0	72.0	118.0	116	2.0	12	3
	8	□	MNS1120-L8C	91.6	129.0	132.0	178.0	176	2.0	12	3
	10	□	MNS1120-L10C	114.0	152.0	155.0	201.0	199	2.0	12	3
	12	□	MNS1120-L12C	136.4	175.0	178.0	224.0	222	2.0	12	3
	15	□	MNS1120-L15C	170.0	209.0	212.0	258.0	256	2.0	12	3
	20	□	MNS1120-L20C	226.0	267.0	270.0	316.0	314	2.0	12	3
	25	□	MNS1120-L25C	282.0	324.0	327.0	373.0	371	2.0	12	3
	5	★	MNS1120LB	58.0	94.0	98.0	160.0	158	2.0	12	3
	10	□	MNS1120X10DB	114.0	152.0	155.0	217.0	215	2.0	12	3
20	□	MNS1120X20DB	226.0	267.0	270.0	332.0	330	2.0	12	3	
11.3	3	□	MNS1130S-DIN	38.1	55.1	56.1	102.1	100	2.1	12	4
	3	□	MNS1130S-DIN-C	38.1	55.1	56.1	102.1	100	2.1	12	3
	5	□	MNS1130L-DIN	54.1	71.1	72.1	118.1	116	2.1	12	4
	5	□	MNS1130L-DIN-C	54.1	71.1	72.1	118.1	116	2.1	12	3
	8	□	MNS1130-L8C	92.5	129.1	132.1	178.1	176	2.1	12	3
	10	□	MNS1130-L10C	115.1	152.1	155.1	201.1	199	2.1	12	3
	12	□	MNS1130-L12C	137.7	175.1	178.1	224.1	222	2.1	12	3
	15	□	MNS1130-L15C	171.6	209.1	212.1	258.1	256	2.1	12	3
	20	□	MNS1130-L20C	228.1	267.1	270.1	316.1	314	2.1	12	3
	25	□	MNS1130-L25C	284.6	324.1	327.1	373.1	371	2.1	12	3
	5	★	MNS1130LB	58.6	94.1	98.1	160.1	158	2.1	12	3
	10	□	MNS1130X10DB	115.1	152.1	155.1	217.1	215	2.1	12	3
20	□	MNS1130X20DB	228.1	267.1	270.1	332.1	330	2.1	12	3	

M

ИНСТРУМЕНТ ДЛЯ
СВЕРЛЕНИЯ

DC (мм)	Глубина сверления (L/D)	TF15	Обозначение	Размеры (мм)							Тип
				LU	LCF	LH	OAL	LF	PL	DCON	
11.4	3	□	MNS1140S-DIN	38.0	55.1	56.1	102.1	100	2.1	12	4
	3	□	MNS1140S-DIN-C	38.0	55.1	56.1	102.1	100	2.1	12	3
	5	□	MNS1140L-DIN	54.0	71.1	72.1	118.1	116	2.1	12	4
	5	□	MNS1140L-DIN-C	54.0	71.1	72.1	118.1	116	2.1	12	3
	8	□	MNS1140-L8C	93.3	129.1	132.1	178.1	176	2.1	12	3
	10	□	MNS1140-L10C	116.1	152.1	155.1	201.1	199	2.1	12	3
	12	□	MNS1140-L12C	138.9	175.1	178.1	224.1	222	2.1	12	3
	15	□	MNS1140-L15C	173.1	209.1	212.1	258.1	256	2.1	12	3
	20	□	MNS1140-L20C	230.1	267.1	270.1	316.1	314	2.1	12	3
	25	□	MNS1140-L25C	287.1	324.1	327.1	373.1	371	2.1	12	3
5	★	MNS1140LB	59.1	94.1	98.1	160.1	158	2.1	12	3	
10	□	MNS1140X10DB	116.1	152.1	155.1	217.1	215	2.1	12	3	
20	□	MNS1140X20DB	230.1	267.1	270.1	332.1	330	2.1	12	3	
11.5	3	□	MNS1150S-DIN	37.8	55.1	56.1	102.1	100	2.1	12	4
	3	□	MNS1150S-DIN-C	37.8	55.1	56.1	102.1	100	2.1	12	3
	5	□	MNS1150L-DIN	53.8	71.1	72.1	118.1	116	2.1	12	4
	5	●	MNS1150L-DIN-C	53.8	71.1	72.1	118.1	116	2.1	12	3
	8	□	MNS1150-L8C	94.1	129.1	132.1	178.1	176	2.1	12	3
	10	□	MNS1150-L10C	117.1	152.1	155.1	201.1	199	2.1	12	3
	12	●	MNS1150-L12C	140.1	175.1	178.1	224.1	222	2.1	12	3
	15	□	MNS1150-L15C	174.6	209.1	212.1	258.1	256	2.1	12	3
	20	●	MNS1150-L20C	232.1	267.1	270.1	316.1	314	2.1	12	3
	25	□	MNS1150-L25C	289.6	324.1	327.1	373.1	371	2.1	12	3
5	★	MNS1150LB	59.6	94.1	98.1	160.1	158	2.1	12	3	
10	□	MNS1150X10DB	117.1	152.1	155.1	217.1	215	2.1	12	3	
20	□	MNS1150X20DB	232.1	267.1	270.1	332.1	330	2.1	12	3	
11.6	3	□	MNS1160S-DIN	37.7	55.1	56.1	102.1	100	2.1	12	4
	3	□	MNS1160S-DIN-C	37.7	55.1	56.1	102.1	100	2.1	12	3
	5	□	MNS1160L-DIN	53.7	71.1	72.1	118.1	116	2.1	12	4
	5	□	MNS1160L-DIN-C	53.7	71.1	72.1	118.1	116	2.1	12	3
	8	□	MNS1160-L8C	94.9	134.1	137.1	183.1	181	2.1	12	3
	10	□	MNS1160-L10C	118.1	158.1	161.1	207.1	205	2.1	12	3
	12	□	MNS1160-L12C	141.3	182.1	185.1	231.1	229	2.1	12	3
	15	□	MNS1160-L15C	176.1	218.1	221.1	267.1	265	2.1	12	3
	20	□	MNS1160-L20C	234.1	278.1	281.1	327.1	325	2.1	12	3
	25	□	MNS1160-L25C	292.1	338.1	341.1	387.1	385	2.1	12	3
5	★	MNS1160LB	60.1	98.1	98.1	160.1	158	2.1	12	3	
10	□	MNS1160X10DB	118.1	158.1	161.1	223.1	221	2.1	12	3	
20	□	MNS1160X20DB	234.1	278.1	281.1	343.1	341	2.1	12	3	
11.7	3	□	MNS1170S-DIN	37.6	55.1	56.1	102.1	100	2.1	12	4
	3	□	MNS1170S-DIN-C	37.6	55.1	56.1	102.1	100	2.1	12	3
	5	□	MNS1170L-DIN	53.6	71.1	72.1	118.1	116	2.1	12	4
	5	□	MNS1170L-DIN-C	53.6	71.1	72.1	118.1	116	2.1	12	3
	8	□	MNS1170-L8C	95.7	134.1	137.1	183.1	181	2.1	12	3
	10	□	MNS1170-L10C	119.1	158.1	161.1	207.1	205	2.1	12	3
	12	□	MNS1170-L12C	142.5	182.1	185.1	231.1	229	2.1	12	3

DC (мм)	Глубина сверления (L/D)	TF15	Обозначение	Размеры (мм)							Тип
				LU	LCF	LH	OAL	LF	PL	DCON	
11.7	15	□	MNS1170-L15C	177.6	218.1	221.1	267.1	265	2.1	12	3
	20	□	MNS1170-L20C	236.1	278.1	281.1	327.1	325	2.1	12	3
	25	□	MNS1170-L25C	294.6	338.1	341.1	387.1	385	2.1	12	3
	5	★	MNS1170LB	60.6	98.1	98.1	160.1	158	2.1	12	3
	10	□	MNS1170X10DB	119.1	158.1	161.1	223.1	221	2.1	12	3
	20	□	MNS1170X20DB	236.1	278.1	281.1	343.1	341	2.1	12	3
11.8	3	□	MNS1180S-DIN	37.4	55.1	56.1	102.1	100	2.1	12	4
	3	□	MNS1180S-DIN-C	37.4	55.1	56.1	102.1	100	2.1	12	3
	5	□	MNS1180L-DIN	53.4	71.1	72.1	118.1	116	2.1	12	4
	5	□	MNS1180L-DIN-C	53.4	71.1	72.1	118.1	116	2.1	12	3
	8	□	MNS1180-L8C	96.5	134.1	137.1	183.1	181	2.1	12	3
	10	□	MNS1180-L10C	120.1	158.1	161.1	207.1	205	2.1	12	3
	12	□	MNS1180-L12C	143.7	182.1	185.1	231.1	229	2.1	12	3
	15	□	MNS1180-L15C	179.1	218.1	221.1	267.1	265	2.1	12	3
	20	□	MNS1180-L20C	238.1	278.1	281.1	327.1	325	2.1	12	3
	25	□	MNS1180-L25C	297.1	338.1	341.1	387.1	385	2.1	12	3
5	★	MNS1180LB	61.1	98.1	98.1	160.1	158	2.1	12	3	
10	□	MNS1180X10DB	120.1	158.1	161.1	223.1	221	2.1	12	3	
20	□	MNS1180X20DB	238.1	278.1	281.1	343.1	341	2.1	12	3	
11.9	3	□	MNS1190S-DIN	37.3	55.2	56.2	102.2	100	2.2	12	4
	3	□	MNS1190S-DIN-C	37.3	55.2	56.2	102.2	100	2.2	12	3
	5	□	MNS1190L-DIN	53.3	71.2	72.2	118.2	116	2.2	12	4
	5	□	MNS1190L-DIN-C	53.3	71.2	72.2	118.2	116	2.2	12	3
	8	□	MNS1190-L8C	97.4	134.2	137.2	183.2	181	2.2	12	3
	10	□	MNS1190-L10C	121.2	158.2	161.2	207.2	205	2.2	12	3
	12	□	MNS1190-L12C	145.0	182.2	185.2	231.2	229	2.2	12	3
	15	□	MNS1190-L15C	180.7	218.2	221.2	267.2	265	2.2	12	3
	20	□	MNS1190-L20C	240.2	278.2	281.2	327.2	325	2.2	12	3
	25	□	MNS1190-L25C	299.7	338.2	341.2	387.2	385	2.2	12	3
5	★	MNS1190LB	61.7	98.2	98.2	160.2	158	2.2	12	3	
10	□	MNS1190X10DB	121.2	158.2	161.2	223.2	221	2.2	12	3	
20	□	MNS1190X20DB	240.2	278.2	281.2	343.2	341	2.2	12	3	
12.0	3	□	MNS1200S-DIN	37.2	55.2	56.2	102.2	100	2.2	12	4
	3	□	MNS1200S-DIN-C	37.2	55.2	56.2	102.2	100	2.2	12	3
	5	□	MNS1200L-DIN	53.2	71.2	72.2	118.2	116	2.2	12	4
	5	●	MNS1200L-DIN-C	53.2	71.2	72.2	118.2	116	2.2	12	3
	8	□	MNS1200-L8C	98.2	134.2	137.2	183.2	181	2.2	12	3
	10	□	MNS1200-L10C	122.2	158.2	161.2	207.2	205	2.2	12	3
	12	●	MNS1200-L12C	146.2	182.2	185.2	231.2	229	2.2	12	3
	15	□	MNS1200-L15C	182.2	218.2	221.2	267.2	265	2.2	12	3
	20	●	MNS1200-L20C	242.2	278.2	281.2	327.2	325	2.2	12	3
	25	□	MNS1200-L25C	302.2	338.2	341.2	387.2	385	2.2	12	3
5	★	MNS1200LB	62.2	98.2	98.2	160.2	158	2.2	12	3	
10	★	MNS1200X10DB	122.2	158.2	161.2	223.2	221	2.2	12	3	
20	★	MNS1200X20DB	242.2	278.2	281.2	343.2	341	2.2	12	3	

Примечание 1) Пожалуйста, свяжитесь с нами если Вы не нашли нужную геометрию в данном каталоге (могут быть заказаны другие диаметры и длины).

● : Есть на складе. ★ : Со склада в Японии.

□ : Нет на складе, выпускается исключительно под заказ.

DC (мм)	Глубина сверления (L/D)	TF15	Обозначение	Размеры (мм)							Тип
				LU	LCF	LH	OAL	LF	PL	DCON	
12.1	3	□	MNS1210S-DIN	42.1	60.2	61.2	107.2	105	2.2	14	4
	3	□	MNS1210S-DIN-C	42.1	60.2	61.2	107.2	105	2.2	14	3
	5	□	MNS1210L-DIN	59.1	77.2	78.2	124.2	122	2.2	14	4
	5	□	MNS1210L-DIN-C	59.1	77.2	78.2	124.2	122	2.2	14	3
	8	□	MNS1210-L8C	99.0	140.2	143.2	189.2	187	2.2	14	3
	10	□	MNS1210-L10C	123.2	165.2	168.2	214.2	212	2.2	14	3
	12	□	MNS1210-L12C	147.4	190.2	193.2	239.2	237	2.2	14	3
	15	□	MNS1210-L15C	183.7	227.2	230.2	276.2	274	2.2	14	3
	20	□	MNS1210-L20C	244.2	290.2	293.2	339.2	337	2.2	14	3
	5	★	MNS1210LB	62.7	102.2	106.2	169.2	167	2.2	13	3
10	□	MNS1210X10DB	123.2	165.2	168.2	231.2	229	2.2	13	3	
20	□	MNS1210X20DB	244.2	290.2	293.2	356.2	354	2.2	13	3	
12.2	3	□	MNS1220S-DIN	41.9	60.2	61.2	107.2	105	2.2	14	4
	3	□	MNS1220S-DIN-C	41.9	60.2	61.2	107.2	105	2.2	14	3
	5	□	MNS1220L-DIN	58.9	77.2	78.2	124.2	122	2.2	14	4
	5	□	MNS1220L-DIN-C	58.9	77.2	78.2	124.2	122	2.2	14	3
	8	□	MNS1220-L8C	99.8	140.2	143.2	189.2	187	2.2	14	3
	10	□	MNS1220-L10C	124.2	165.2	168.2	214.2	212	2.2	14	3
	12	□	MNS1220-L12C	148.6	190.2	193.2	239.2	237	2.2	14	3
	15	□	MNS1220-L15C	185.2	227.2	230.2	276.2	274	2.2	14	3
	20	□	MNS1220-L20C	246.2	290.2	293.2	339.2	337	2.2	14	3
	5	★	MNS1220LB	63.2	102.2	106.2	169.2	167	2.2	13	3
10	□	MNS1220X10DB	124.2	165.2	168.2	231.2	229	2.2	13	3	
20	□	MNS1220X20DB	246.2	290.2	293.2	356.2	354	2.2	13	3	
12.3	3	□	MNS1230S-DIN	41.8	60.2	61.2	107.2	105	2.2	14	4
	3	□	MNS1230S-DIN-C	41.8	60.2	61.2	107.2	105	2.2	14	3
	5	□	MNS1230L-DIN	58.8	77.2	78.2	124.2	122	2.2	14	4
	5	□	MNS1230L-DIN-C	58.8	77.2	78.2	124.2	122	2.2	14	3
	8	□	MNS1230-L8C	100.6	140.2	143.2	189.2	187	2.2	14	3
	10	□	MNS1230-L10C	125.2	165.2	168.2	214.2	212	2.2	14	3
	12	□	MNS1230-L12C	149.8	190.2	193.2	239.2	237	2.2	14	3
	15	□	MNS1230-L15C	186.7	227.2	230.2	276.2	274	2.2	14	3
	20	□	MNS1230-L20C	248.2	290.2	293.2	339.2	337	2.2	14	3
	5	★	MNS1230LB	63.7	102.2	106.2	169.2	167	2.2	13	3
10	□	MNS1230X10DB	125.2	165.2	168.2	231.2	229	2.2	13	3	
20	□	MNS1230X20DB	248.2	290.2	293.2	356.2	354	2.2	13	3	
12.4	3	□	MNS1240S-DIN	41.7	60.3	61.3	107.3	105	2.3	14	4
	3	□	MNS1240S-DIN-C	41.7	60.3	61.3	107.3	105	2.3	14	3
	5	□	MNS1240L-DIN	58.7	77.3	78.3	124.3	122	2.3	14	4
	5	□	MNS1240L-DIN-C	58.7	77.3	78.3	124.3	122	2.3	14	3
	8	□	MNS1240-L8C	101.5	140.3	143.3	189.3	187	2.3	14	3
	10	□	MNS1240-L10C	126.3	165.3	168.3	214.3	212	2.3	14	3
	12	□	MNS1240-L12C	151.1	190.3	193.3	239.3	237	2.3	14	3
	15	□	MNS1240-L15C	188.3	227.3	230.3	276.3	274	2.3	14	3
	20	□	MNS1240-L20C	250.3	290.3	293.3	339.3	337	2.3	14	3
	5	★	MNS1240LB	64.3	102.3	106.3	169.3	167	2.3	13	3
10	□	MNS1240X10DB	126.3	165.3	168.3	231.3	229	2.3	13	3	
20	□	MNS1240X20DB	250.3	290.3	293.3	356.3	354	2.3	13	3	

DC (мм)	Глубина сверления (L/D)	TF15	Обозначение	Размеры (мм)							Тип
				LU	LCF	LH	OAL	LF	PL	DCON	
12.5	3	□	MNS1250S-DIN	41.5	60.3	61.3	107.3	105	2.3	14	4
	3	□	MNS1250S-DIN-C	41.5	60.3	61.3	107.3	105	2.3	14	3
	5	□	MNS1250L-DIN	58.5	77.3	78.3	124.3	122	2.3	14	4
	5	●	MNS1250L-DIN-C	58.5	77.3	78.3	124.3	122	2.3	14	3
	8	□	MNS1250-L8C	102.3	140.3	143.3	189.3	187	2.3	14	3
	10	□	MNS1250-L10C	127.3	165.3	168.3	214.3	212	2.3	14	3
	12	●	MNS1250-L12C	152.3	190.3	193.3	239.3	237	2.3	14	3
	15	□	MNS1250-L15C	189.8	227.3	230.3	276.3	274	2.3	14	3
	20	●	MNS1250-L20C	252.3	290.3	293.3	339.3	337	2.3	14	3
	5	★	MNS1250LB	64.8	102.3	106.3	169.3	167	2.3	13	3
10	□	MNS1250X10DB	127.3	165.3	168.3	231.3	229	2.3	13	3	
20	□	MNS1250X20DB	252.3	290.3	293.3	356.3	354	2.3	13	3	
12.6	3	□	MNS1260S-DIN	41.4	60.3	61.3	107.3	105	2.3	14	4
	3	□	MNS1260S-DIN-C	41.4	60.3	61.3	107.3	105	2.3	14	3
	5	□	MNS1260L-DIN	58.4	77.3	78.3	124.3	122	2.3	14	4
	5	□	MNS1260L-DIN-C	58.4	77.3	78.3	124.3	122	2.3	14	3
	8	□	MNS1260-L8C	103.1	145.3	148.3	194.3	192	2.3	14	3
	10	□	MNS1260-L10C	128.3	171.3	174.3	220.3	218	2.3	14	3
	12	□	MNS1260-L12C	153.5	197.3	200.3	246.3	244	2.3	14	3
	15	□	MNS1260-L15C	191.3	236.3	239.3	285.3	283	2.3	14	3
	20	□	MNS1260-L20C	254.3	301.3	304.3	350.3	348	2.3	14	3
	5	★	MNS1260LB	65.3	106.3	106.3	169.3	167	2.3	13	3
10	□	MNS1260X10DB	128.3	171.3	174.3	237.3	235	2.3	13	3	
20	□	MNS1260X20DB	254.3	301.3	304.3	367.3	365	2.3	13	3	
12.7	3	□	MNS1270S-DIN	41.3	60.3	61.3	107.3	105	2.3	14	4
	3	□	MNS1270S-DIN-C	41.3	60.3	61.3	107.3	105	2.3	14	3
	5	□	MNS1270L-DIN	58.3	77.3	78.3	124.3	122	2.3	14	4
	5	□	MNS1270L-DIN-C	58.3	77.3	78.3	124.3	122	2.3	14	3
	8	□	MNS1270-L8C	103.9	145.3	148.3	194.3	192	2.3	14	3
	10	□	MNS1270-L10C	129.3	171.3	174.3	220.3	218	2.3	14	3
	12	□	MNS1270-L12C	154.7	197.3	200.3	246.3	244	2.3	14	3
	15	□	MNS1270-L15C	192.8	236.3	239.3	285.3	283	2.3	14	3
	20	□	MNS1270-L20C	256.3	301.3	304.3	350.3	348	2.3	14	3
	5	★	MNS1270LB	65.8	106.3	106.3	169.3	167	2.3	13	3
10	□	MNS1270X10DB	129.3	171.3	174.3	237.3	235	2.3	13	3	
20	□	MNS1270X20DB	256.3	301.3	304.3	367.3	365	2.3	13	3	
12.8	3	□	MNS1280S-DIN	41.1	60.3	61.3	107.3	105	2.3	14	4
	3	□	MNS1280S-DIN-C	41.1	60.3	61.3	107.3	105	2.3	14	3
	5	□	MNS1280L-DIN	58.1	77.3	78.3	124.3	122	2.3	14	4
	5	□	MNS1280L-DIN-C	58.1	77.3	78.3	124.3	122	2.3	14	3
	8	□	MNS1280-L8C	104.7	145.3	148.3	194.3	192	2.3	14	3
	10	□	MNS1280-L10C	130.3	171.3	174.3	220.3	218	2.3	14	3
	12	□	MNS1280-L12C	155.9	197.3	200.3	246.3	244	2.3	14	3
	15	□	MNS1280-L15C	194.3	236.3	239.3	285.3	283	2.3	14	3
	20	□	MNS1280-L20C	258.3	301.3	304.3	350.3	348	2.3	14	3
	5	★	MNS1280LB	66.3	106.3	106.3	169.3	167	2.3	13	3
10	□	MNS1280X10DB	130.3	171.3	174.3	237.3	235	2.3	13	3	
20	□	MNS1280X20DB	258.3	301.3	304.3	367.3	365	2.3	13	3	

М
ИНСТРУМЕНТ ДЛЯ СВЕРЛЕНИЯ

DC (мм)	Глубина сверления (L/D)	TF15	Обозначение	Размеры (мм)							Тип
				LU	LCF	LH	OAL	LF	PL	DCON	
12.9	3	□	MNS1290S-DIN	41.0	60.3	61.3	107.3	105	2.3	14	4
	3	□	MNS1290S-DIN-C	41.0	60.3	61.3	107.3	105	2.3	14	3
	5	□	MNS1290L-DIN	58.0	77.3	78.3	124.3	122	2.3	14	4
	5	□	MNS1290L-DIN-C	58.0	77.3	78.3	124.3	122	2.3	14	3
	8	□	MNS1290-L8C	105.5	145.3	148.3	194.3	192	2.3	14	3
	10	□	MNS1290-L10C	131.3	171.3	174.3	220.3	218	2.3	14	3
	12	□	MNS1290-L12C	157.1	197.3	200.3	246.3	244	2.3	14	3
	15	□	MNS1290-L15C	195.8	236.3	239.3	285.3	283	2.3	14	3
	20	□	MNS1290-L20C	260.3	301.3	304.3	350.3	348	2.3	14	3
	5	★	MNS1290LB	66.8	106.3	106.3	169.3	167	2.3	13	3
10	□	MNS1290X10DB	131.3	171.3	174.3	237.3	235	2.3	13	3	
20	□	MNS1290X20DB	260.3	301.3	304.3	367.3	365	2.3	13	3	
13.0	3	□	MNS1300S-DIN	40.9	60.4	61.4	107.4	105	2.4	14	4
	3	□	MNS1300S-DIN-C	40.9	60.4	61.4	107.4	105	2.4	14	3
	5	□	MNS1300L-DIN	57.9	77.4	78.4	124.4	122	2.4	14	4
	5	●	MNS1300L-DIN-C	57.9	77.4	78.4	124.4	122	2.4	14	3
	8	□	MNS1300-L8C	106.4	145.4	148.4	194.4	192	2.4	14	3
	10	□	MNS1300-L10C	132.4	171.4	174.4	220.4	218	2.4	14	3
	12	●	MNS1300-L12C	158.4	197.4	200.4	246.4	244	2.4	14	3
	15	□	MNS1300-L15C	197.4	236.4	239.4	285.4	283	2.4	14	3
	20	●	MNS1300-L20C	262.4	301.4	304.4	350.4	348	2.4	14	3
	5	★	MNS1300LB	67.4	106.4	106.4	169.4	167	2.4	13	3
10	★	MNS1300X10DB	132.4	171.4	174.4	237.4	235	2.4	13	3	
20	★	MNS1300X20DB	262.4	301.4	304.4	367.4	365	2.4	13	3	
13.1	3	□	MNS1310S-DIN	40.7	60.4	61.4	107.4	105	2.4	14	4
	3	□	MNS1310S-DIN-C	40.7	60.4	61.4	107.4	105	2.4	14	3
	5	□	MNS1310L-DIN	57.7	77.4	78.4	124.4	122	2.4	14	4
	5	□	MNS1310L-DIN-C	57.7	77.4	78.4	124.4	122	2.4	14	3
	8	□	MNS1310-L8C	107.2	151.4	154.4	200.4	198	2.4	14	3
	10	□	MNS1310-L10C	133.4	178.4	181.4	227.4	225	2.4	14	3
	12	□	MNS1310-L12C	159.6	205.4	208.4	254.4	252	2.4	14	3
	15	□	MNS1310-L15C	198.9	245.4	248.4	294.4	292	2.4	14	3
	20	□	MNS1310-L20C	264.4	313.4	316.4	362.4	360	2.4	14	3
	5	★	MNS1310LB	67.9	110.4	114.4	178.4	176	2.4	14	3
10	□	MNS1310X10DB	133.4	178.4	181.4	245.4	243	2.4	14	3	
20	□	MNS1310X20DB	264.4	313.4	316.4	380.4	378	2.4	14	3	
13.2	3	□	MNS1320S-DIN	40.6	60.4	61.4	107.4	105	2.4	14	4
	3	□	MNS1320S-DIN-C	40.6	60.4	61.4	107.4	105	2.4	14	3
	5	□	MNS1320L-DIN	57.6	77.4	78.4	124.4	122	2.4	14	4
	5	□	MNS1320L-DIN-C	57.6	77.4	78.4	124.4	122	2.4	14	3
	8	□	MNS1320-L8C	108.0	151.4	154.4	200.4	198	2.4	14	3
	10	□	MNS1320-L10C	134.4	178.4	181.4	227.4	225	2.4	14	3
	12	□	MNS1320-L12C	160.8	205.4	208.4	254.4	252	2.4	14	3
	15	□	MNS1320-L15C	200.4	245.4	248.4	294.4	292	2.4	14	3
	20	□	MNS1320-L20C	266.4	313.4	316.4	362.4	360	2.4	14	3
	5	★	MNS1320LB	68.4	110.4	114.4	178.4	176	2.4	14	3
10	□	MNS1320X10DB	134.4	178.4	181.4	245.4	243	2.4	14	3	
20	□	MNS1320X20DB	266.4	313.4	316.4	380.4	378	2.4	14	3	

DC (мм)	Глубина сверления (L/D)	TF15	Обозначение	Размеры (мм)							Тип
				LU	LCF	LH	OAL	LF	PL	DCON	
13.3	3	□	MNS1330S-DIN	40.5	60.4	61.4	107.4	105	2.4	14	4
	3	□	MNS1330S-DIN-C	40.5	60.4	61.4	107.4	105	2.4	14	3
	5	□	MNS1330L-DIN	57.5	77.4	78.4	124.4	122	2.4	14	4
	5	□	MNS1330L-DIN-C	57.5	77.4	78.4	124.4	122	2.4	14	3
	8	□	MNS1330-L8C	108.8	151.4	154.4	200.4	198	2.4	14	3
	10	□	MNS1330-L10C	135.4	178.4	181.4	227.4	225	2.4	14	3
	12	□	MNS1330-L12C	162.0	205.4	208.4	254.4	252	2.4	14	3
	15	□	MNS1330-L15C	201.9	245.4	248.4	294.4	292	2.4	14	3
	20	□	MNS1330-L20C	268.4	313.4	316.4	362.4	360	2.4	14	3
	5	★	MNS1330LB	68.9	110.4	114.4	178.4	176	2.4	14	3
10	□	MNS1330X10DB	135.4	178.4	181.4	245.4	243	2.4	14	3	
20	□	MNS1330X20DB	268.4	313.4	316.4	380.4	378	2.4	14	3	
13.4	3	□	MNS1340S-DIN	40.3	60.4	61.4	107.4	105	2.4	14	4
	3	□	MNS1340S-DIN-C	40.3	60.4	61.4	107.4	105	2.4	14	3
	5	□	MNS1340L-DIN	57.3	77.4	78.4	124.4	122	2.4	14	4
	5	□	MNS1340L-DIN-C	57.3	77.4	78.4	124.4	122	2.4	14	3
	8	□	MNS1340-L8C	109.6	151.4	154.4	200.4	198	2.4	14	3
	10	□	MNS1340-L10C	136.4	178.4	181.4	227.4	225	2.4	14	3
	12	□	MNS1340-L12C	163.2	205.4	208.4	254.4	252	2.4	14	3
	15	□	MNS1340-L15C	203.4	245.4	248.4	294.4	292	2.4	14	3
	20	□	MNS1340-L20C	270.4	313.4	316.4	362.4	360	2.4	14	3
	5	★	MNS1340LB	69.4	110.4	114.4	178.4	176	2.4	14	3
10	□	MNS1340X10DB	136.4	178.4	181.4	245.4	243	2.4	14	3	
20	□	MNS1340X20DB	270.4	313.4	316.4	380.4	378	2.4	14	3	
13.5	3	□	MNS1350S-DIN	40.2	60.5	61.5	107.5	105	2.5	14	4
	3	□	MNS1350S-DIN-C	40.2	60.5	61.5	107.5	105	2.5	14	3
	5	□	MNS1350L-DIN	57.2	77.5	78.5	124.5	122	2.5	14	4
	5	●	MNS1350L-DIN-C	57.2	77.5	78.5	124.5	122	2.5	14	3
	8	□	MNS1350-L8C	110.5	151.5	154.5	200.5	198	2.5	14	3
	10	□	MNS1350-L10C	137.5	178.5	181.5	227.5	225	2.5	14	3
	12	●	MNS1350-L12C	164.5	205.5	208.5	254.5	252	2.5	14	3
	15	□	MNS1350-L15C	205.0	245.5	248.5	294.5	292	2.5	14	3
	20	●	MNS1350-L20C	272.5	313.5	316.5	362.5	360	2.5	14	3
	5	★	MNS1350LB	70.0	110.5	114.5	178.5	176	2.5	14	3
10	□	MNS1350X10DB	137.5	178.5	181.5	245.5	243	2.5	14	3	
20	□	MNS1350X20DB	272.5	313.5	316.5	380.5	378	2.5	14	3	
13.6	3	□	MNS1360S-DIN	40.1	60.5	61.5	107.5	105	2.5	14	4
	3	□	MNS1360S-DIN-C	40.1	60.5	61.5	107.5	105	2.5	14	3
	5	□	MNS1360L-DIN	57.1	77.5	78.5	124.5	122	2.5	14	4
	5	□	MNS1360L-DIN-C	57.1	77.5	78.5	124.5	122	2.5	14	3
	8	□	MNS1360-L8C	111.3	156.5	159.5	205.5	203	2.5	14	3
	10	□	MNS1360-L10C	138.5	184.5	187.5	233.5	231	2.5	14	3
	12	□	MNS1360-L12C	165.7	212.5	215.5	261.5	259	2.5	14	3
	15	□	MNS1360-L15C	206.5	254.5	257.5	303.5	301	2.5	14	3
	20	□	MNS1360-L20C	274.5	324.5	327.5	373.5	371	2.5	14	3
	5	★	MNS1360LB	70.5	114.5	114.5	178.5	176	2.5	14	3
10	□	MNS1360X10DB	138.5	184.5	187.5	251.5	249	2.5	14	3	
20	□	MNS1360X20DB	274.5	324.5	327.5	391.5	389	2.5	14	3	

Примечание 1) Пожалуйста, свяжитесь с нами если Вы не нашли нужную геометрию в данном каталоге (могут быть заказаны другие диаметры и длины).

● : Есть на складе. ★ : Со склада в Японии.

□ : Нет на складе, выпускается исключительно под заказ.

DC (мм)	Глубина сверления (L/D)	TF/15	Обозначение	Размеры (мм)							Тип
				LU	LCF	LH	OAL	LF	PL	DCON	
13.7	3	□	MNS1370S-DIN	39.9	60.5	61.5	107.5	105	2.5	14	4
	3	□	MNS1370S-DIN-C	39.9	60.5	61.5	107.5	105	2.5	14	3
	5	□	MNS1370L-DIN	56.9	77.5	78.5	124.5	122	2.5	14	4
	5	□	MNS1370L-DIN-C	56.9	77.5	78.5	124.5	122	2.5	14	3
	8	□	MNS1370-L8C	112.1	156.5	159.5	205.5	203	2.5	14	3
	10	□	MNS1370-L10C	139.5	184.5	187.5	233.5	231	2.5	14	3
	12	□	MNS1370-L12C	166.9	212.5	215.5	261.5	259	2.5	14	3
	15	□	MNS1370-L15C	208.0	254.5	257.5	303.5	301	2.5	14	3
	20	□	MNS1370-L20C	276.5	324.5	327.5	373.5	371	2.5	14	3
	5	★	MNS1370LB	71.0	114.5	114.5	178.5	176	2.5	14	3
10	□	MNS1370X10DB	139.5	184.5	187.5	251.5	249	2.5	14	3	
20	□	MNS1370X20DB	276.5	324.5	327.5	391.5	389	2.5	14	3	
13.8	3	□	MNS1380S-DIN	39.8	60.5	61.5	107.5	105	2.5	14	4
	3	□	MNS1380S-DIN-C	39.8	60.5	61.5	107.5	105	2.5	14	3
	5	□	MNS1380L-DIN	56.8	77.5	78.5	124.5	122	2.5	14	4
	5	□	MNS1380L-DIN-C	56.8	77.5	78.5	124.5	122	2.5	14	3
	8	□	MNS1380-L8C	112.9	156.5	159.5	205.5	203	2.5	14	3
	10	□	MNS1380-L10C	140.5	184.5	187.5	233.5	231	2.5	14	3
	12	□	MNS1380-L12C	168.1	212.5	215.5	261.5	259	2.5	14	3
	15	□	MNS1380-L15C	209.5	254.5	257.5	303.5	301	2.5	14	3
	20	□	MNS1380-L20C	278.5	324.5	327.5	373.5	371	2.5	14	3
	5	★	MNS1380LB	71.5	114.5	114.5	178.5	176	2.5	14	3
10	□	MNS1380X10DB	140.5	184.5	187.5	251.5	249	2.5	14	3	
20	□	MNS1380X20DB	278.5	324.5	327.5	391.5	389	2.5	14	3	
13.9	3	□	MNS1390S-DIN	39.7	60.5	61.5	107.5	105	2.5	14	4
	3	□	MNS1390S-DIN-C	39.7	60.5	61.5	107.5	105	2.5	14	3
	5	□	MNS1390L-DIN	56.7	77.5	78.5	124.5	122	2.5	14	4
	5	□	MNS1390L-DIN-C	56.7	77.5	78.5	124.5	122	2.5	14	3
	8	□	MNS1390-L8C	113.7	156.5	159.5	205.5	203	2.5	14	3
	10	□	MNS1390-L10C	141.5	184.5	187.5	233.5	231	2.5	14	3
	12	□	MNS1390-L12C	169.3	212.5	215.5	261.5	259	2.5	14	3
	15	□	MNS1390-L15C	211.0	254.5	257.5	303.5	301	2.5	14	3
	20	□	MNS1390-L20C	280.5	324.5	327.5	373.5	371	2.5	14	3
	5	★	MNS1390LB	72.0	114.5	114.5	178.5	176	2.5	14	3
10	□	MNS1390X10DB	141.5	184.5	187.5	251.5	249	2.5	14	3	
20	□	MNS1390X20DB	280.5	324.5	327.5	391.5	389	2.5	14	3	
14.0	3	□	MNS1400S-DIN	39.5	60.5	61.5	107.5	105	2.5	14	4
	3	□	MNS1400S-DIN-C	39.5	60.5	61.5	107.5	105	2.5	14	3
	5	□	MNS1400L-DIN	56.5	77.5	78.5	124.5	122	2.5	14	4
	5	●	MNS1400L-DIN-C	56.5	77.5	78.5	124.5	122	2.5	14	3
	8	□	MNS1400-L8C	114.5	156.5	159.5	205.5	203	2.5	14	3
	10	□	MNS1400-L10C	142.5	184.5	187.5	233.5	231	2.5	14	3
	12	●	MNS1400-L12C	170.5	212.5	215.5	261.5	259	2.5	14	3
	15	□	MNS1400-L15C	212.5	254.5	257.5	303.5	301	2.5	14	3
	20	●	MNS1400-L20C	282.5	324.5	327.5	373.5	371	2.5	14	3
	5	★	MNS1400LB	72.5	114.5	114.5	178.5	176	2.5	14	3
10	★	MNS1400X10DB	142.5	184.5	187.5	251.5	249	2.5	14	3	
20	★	MNS1400X20DB	282.5	324.5	327.5	391.5	389	2.5	14	3	

DC (мм)	Глубина сверления (L/D)	TF/15	Обозначение	Размеры (мм)							Тип
				LU	LCF	LH	OAL	LF	PL	DCON	
14.1	3	□	MNS1410S-DIN	43.4	64.6	65.6	114.6	112	2.6	16	4
	3	□	MNS1410S-DIN-C	43.4	64.6	65.6	114.6	112	2.6	16	3
	5	□	MNS1410L-DIN	61.4	82.6	83.6	132.6	130	2.6	16	4
	5	□	MNS1410L-DIN-C	61.4	82.6	83.6	132.6	130	2.6	16	3
14.2	3	□	MNS1420S-DIN	43.3	64.6	65.6	114.6	112	2.6	16	4
	3	□	MNS1420S-DIN-C	43.3	64.6	65.6	114.6	112	2.6	16	3
	5	□	MNS1420L-DIN	61.3	82.6	83.6	132.6	130	2.6	16	4
5	●	MNS1420L-DIN-C	61.3	82.6	83.6	132.6	130	2.6	16	3	
14.3	3	□	MNS1430S-DIN	43.2	64.6	65.6	114.6	112	2.6	16	4
	3	□	MNS1430S-DIN-C	43.2	64.6	65.6	114.6	112	2.6	16	3
	5	□	MNS1430L-DIN	61.2	82.6	83.6	132.6	130	2.6	16	4
	5	□	MNS1430L-DIN-C	61.2	82.6	83.6	132.6	130	2.6	16	3
14.4	3	□	MNS1440S-DIN	43.0	64.6	65.6	114.6	112	2.6	16	4
	3	□	MNS1440S-DIN-C	43.0	64.6	65.6	114.6	112	2.6	16	3
	5	□	MNS1440L-DIN	61.0	82.6	83.6	132.6	130	2.6	16	4
	5	□	MNS1440L-DIN-C	61.0	82.6	83.6	132.6	130	2.6	16	3
14.5	3	□	MNS1450S-DIN	42.9	64.6	65.6	114.6	112	2.6	16	4
	3	□	MNS1450S-DIN-C	42.9	64.6	65.6	114.6	112	2.6	16	3
	5	□	MNS1450L-DIN	60.9	82.6	83.6	132.6	130	2.6	16	4
5	●	MNS1450L-DIN-C	60.9	82.6	83.6	132.6	130	2.6	16	3	
14.6	3	□	MNS1460S-DIN	42.8	64.7	65.7	114.7	112	2.7	16	4
	3	□	MNS1460S-DIN-C	42.8	64.7	65.7	114.7	112	2.7	16	3
	5	□	MNS1460L-DIN	60.8	82.7	83.7	132.7	130	2.7	16	4
	5	□	MNS1460L-DIN-C	60.8	82.7	83.7	132.7	130	2.7	16	3
14.7	3	□	MNS1470S-DIN	42.6	64.7	65.7	114.7	112	2.7	16	4
	3	□	MNS1470S-DIN-C	42.6	64.7	65.7	114.7	112	2.7	16	3
	5	□	MNS1470L-DIN	60.6	82.7	83.7	132.7	130	2.7	16	4
	5	□	MNS1470L-DIN-C	60.6	82.7	83.7	132.7	130	2.7	16	3
14.8	3	□	MNS1480S-DIN	42.5	64.7	65.7	114.7	112	2.7	16	4
	3	□	MNS1480S-DIN-C	42.5	64.7	65.7	114.7	112	2.7	16	3
	5	□	MNS1480L-DIN	60.5	82.7	83.7	132.7	130	2.7	16	4
	5	□	MNS1480L-DIN-C	60.5	82.7	83.7	132.7	130	2.7	16	3
14.9	3	□	MNS1490S-DIN	42.4	64.7	65.7	114.7	112	2.7	16	4
	3	□	MNS1490S-DIN-C	42.4	64.7	65.7	114.7	112	2.7	16	3
	5	□	MNS1490L-DIN	60.4	82.7	83.7	132.7	130	2.7	16	4
	5	□	MNS1490L-DIN-C	60.4	82.7	83.7	132.7	130	2.7	16	3
15.0	3	□	MNS1500S-DIN	42.2	64.7	65.7	114.7	112	2.7	16	4
	3	□	MNS1500S-DIN-C	42.2	64.7	65.7	114.7	112	2.7	16	3
	5	□	MNS1500L-DIN	60.2	82.7	83.7	132.7	130	2.7	16	4
	5	●	MNS1500L-DIN-C	60.2	82.7	83.7	132.7	130	2.7	16	3
15.1	3	□	MNS1510S-DIN	42.1	64.7	65.7	114.7	112	2.7	16	4
	3	□	MNS1510S-DIN-C	42.1	64.7	65.7	114.7	112	2.7	16	3
	5	□	MNS1510L-DIN	60.1	82.7	83.7	132.7	130	2.7	16	4
	5	□	MNS1510L-DIN-C	60.1	82.7	83.7	132.7	130	2.7	16	3
15.2	3	□	MNS1520S-DIN	42.0	64.8	65.8	114.8	112	2.8	16	4
	3	□	MNS1520S-DIN-C	42.0	64.8	65.8	114.8	112	2.8	16	3
	5	□	MNS1520L-DIN	60.0	82.8	83.8	132.8	130	2.8	16	4
	5	□	MNS1520L-DIN-C	60.0	82.8	83.8	132.8	130	2.8	16	3

M

ИНСТРУМЕНТ ДЛЯ
СВЕРЛЕНИЯ

ИНСТРУМЕНТ ДЛЯ СВЕРЛЕНИЯ (МОНОЛИТНЫЕ ТВЕРДОСПЛАВНЫЕ СВЕРЛА)

MNS

ТВЕРДЫЙ
СПЛАВ

M

ИНСТРУМЕНТ ДЛЯ
СВЕРЛЕНИЯ

DC (мм)	Глубина сверления (L/D)	TF15	Обозначение	Размеры (мм)							Тип
				LU	LCF	LH	OAL	LF	PL	DCON	
15.3	3	<input type="checkbox"/>	MNS1530S-DIN	41.8	64.8	65.8	114.8	112	2.8	16	4
	3	<input type="checkbox"/>	MNS1530S-DIN-C	41.8	64.8	65.8	114.8	112	2.8	16	3
	5	<input type="checkbox"/>	MNS1530L-DIN	59.8	82.8	83.8	132.8	130	2.8	16	4
	5	<input type="checkbox"/>	MNS1530L-DIN-C	59.8	82.8	83.8	132.8	130	2.8	16	3
15.4	3	<input type="checkbox"/>	MNS1540S-DIN	41.7	64.8	65.8	114.8	112	2.8	16	4
	3	<input type="checkbox"/>	MNS1540S-DIN-C	41.7	64.8	65.8	114.8	112	2.8	16	3
	5	<input type="checkbox"/>	MNS1540L-DIN	59.7	82.8	83.8	132.8	130	2.8	16	4
	5	<input type="checkbox"/>	MNS1540L-DIN-C	59.7	82.8	83.8	132.8	130	2.8	16	3
15.5	3	<input type="checkbox"/>	MNS1550S-DIN	41.6	64.8	65.8	114.8	112	2.8	16	4
	3	<input type="checkbox"/>	MNS1550S-DIN-C	41.6	64.8	65.8	114.8	112	2.8	16	3
	5	<input type="checkbox"/>	MNS1550L-DIN	59.6	82.8	83.8	132.8	130	2.8	16	4
	5	<input checked="" type="checkbox"/>	MNS1550L-DIN-C	59.6	82.8	83.8	132.8	130	2.8	16	3
15.6	3	<input type="checkbox"/>	MNS1560S-DIN	41.4	64.8	65.8	114.8	112	2.8	16	4
	3	<input type="checkbox"/>	MNS1560S-DIN-C	41.4	64.8	65.8	114.8	112	2.8	16	3
	5	<input type="checkbox"/>	MNS1560L-DIN	59.4	82.8	83.8	132.8	130	2.8	16	4
	5	<input type="checkbox"/>	MNS1560L-DIN-C	59.4	82.8	83.8	132.8	130	2.8	16	3
15.7	3	<input type="checkbox"/>	MNS1570S-DIN	41.3	64.9	65.9	114.9	112	2.9	16	4
	3	<input type="checkbox"/>	MNS1570S-DIN-C	41.3	64.9	65.9	114.9	112	2.9	16	3
	5	<input type="checkbox"/>	MNS1570L-DIN	59.3	82.9	83.9	132.9	130	2.9	16	4
	5	<input type="checkbox"/>	MNS1570L-DIN-C	59.3	82.9	83.9	132.9	130	2.9	16	3
15.8	3	<input type="checkbox"/>	MNS1580S-DIN	41.2	64.9	65.9	114.9	112	2.9	16	4
	3	<input type="checkbox"/>	MNS1580S-DIN-C	41.2	64.9	65.9	114.9	112	2.9	16	3
	5	<input type="checkbox"/>	MNS1580L-DIN	59.2	82.9	83.9	132.9	130	2.9	16	4
	5	<input type="checkbox"/>	MNS1580L-DIN-C	59.2	82.9	83.9	132.9	130	2.9	16	3
15.9	3	<input type="checkbox"/>	MNS1590S-DIN	41.0	64.9	65.9	114.9	112	2.9	16	4
	3	<input type="checkbox"/>	MNS1590S-DIN-C	41.0	64.9	65.9	114.9	112	2.9	16	3
	5	<input type="checkbox"/>	MNS1590L-DIN	59.0	82.9	83.9	132.9	130	2.9	16	4
	5	<input type="checkbox"/>	MNS1590L-DIN-C	59.0	82.9	83.9	132.9	130	2.9	16	3
16.0	3	<input type="checkbox"/>	MNS1600S-DIN	40.9	64.9	65.9	114.9	112	2.9	16	4
	3	<input type="checkbox"/>	MNS1600S-DIN-C	40.9	64.9	65.9	114.9	112	2.9	16	3
	5	<input type="checkbox"/>	MNS1600L-DIN	58.9	82.9	83.9	132.9	130	2.9	16	4
	5	<input checked="" type="checkbox"/>	MNS1600L-DIN-C	58.9	82.9	83.9	132.9	130	2.9	16	3
16.1	3	<input type="checkbox"/>	MNS1610S-DIN	48.8	72.9	73.9	122.9	120	2.9	18	4
	3	<input type="checkbox"/>	MNS1610S-DIN-C	48.8	72.9	73.9	122.9	120	2.9	18	3
	5	<input type="checkbox"/>	MNS1610L-DIN	68.8	92.9	93.9	142.9	140	2.9	18	4
	5	<input type="checkbox"/>	MNS1610L-DIN-C	68.8	92.9	93.9	142.9	140	2.9	18	3
16.2	3	<input type="checkbox"/>	MNS1620S-DIN	48.6	72.9	73.9	122.9	120	2.9	18	4
	3	<input type="checkbox"/>	MNS1620S-DIN-C	48.6	72.9	73.9	122.9	120	2.9	18	3
	5	<input type="checkbox"/>	MNS1620L-DIN	68.6	92.9	93.9	142.9	140	2.9	18	4
	5	<input type="checkbox"/>	MNS1620L-DIN-C	68.6	92.9	93.9	142.9	140	2.9	18	3
16.3	3	<input type="checkbox"/>	MNS1630S-DIN	48.5	73.0	74.0	123.0	120	3.0	18	4
	3	<input type="checkbox"/>	MNS1630S-DIN-C	48.5	73.0	74.0	123.0	120	3.0	18	3
	5	<input type="checkbox"/>	MNS1630L-DIN	68.5	93.0	94.0	143.0	140	3.0	18	4
	5	<input type="checkbox"/>	MNS1630L-DIN-C	68.5	93.0	94.0	143.0	140	3.0	18	3
16.4	3	<input type="checkbox"/>	MNS1640S-DIN	48.4	73.0	74.0	123.0	120	3.0	18	4
	3	<input type="checkbox"/>	MNS1640S-DIN-C	48.4	73.0	74.0	123.0	120	3.0	18	3
	5	<input type="checkbox"/>	MNS1640L-DIN	68.4	93.0	94.0	143.0	140	3.0	18	4
	5	<input type="checkbox"/>	MNS1640L-DIN-C	68.4	93.0	94.0	143.0	140	3.0	18	3

DC (мм)	Глубина сверления (L/D)	TF15	Обозначение	Размеры (мм)							Тип
				LU	LCF	LH	OAL	LF	PL	DCON	
16.5	3	<input type="checkbox"/>	MNS1650S-DIN	48.3	73.0	74.0	123.0	120	3.0	18	4
	3	<input type="checkbox"/>	MNS1650S-DIN-C	48.3	73.0	74.0	123.0	120	3.0	18	3
	5	<input type="checkbox"/>	MNS1650L-DIN	68.3	93.0	94.0	143.0	140	3.0	18	4
	5	<input checked="" type="checkbox"/>	MNS1650L-DIN-C	68.3	93.0	94.0	143.0	140	3.0	18	3
16.6	3	<input type="checkbox"/>	MNS1660S-DIN	48.1	73.0	74.0	123.0	120	3.0	18	4
	3	<input type="checkbox"/>	MNS1660S-DIN-C	48.1	73.0	74.0	123.0	120	3.0	18	3
	5	<input type="checkbox"/>	MNS1660L-DIN	68.1	93.0	94.0	143.0	140	3.0	18	4
	5	<input type="checkbox"/>	MNS1660L-DIN-C	68.1	93.0	94.0	143.0	140	3.0	18	3
16.7	3	<input type="checkbox"/>	MNS1670S-DIN	48.0	73.0	74.0	123.0	120	3.0	18	4
	3	<input type="checkbox"/>	MNS1670S-DIN-C	48.0	73.0	74.0	123.0	120	3.0	18	3
	5	<input type="checkbox"/>	MNS1670L-DIN	68.0	93.0	94.0	143.0	140	3.0	18	4
	5	<input type="checkbox"/>	MNS1670L-DIN-C	68.0	93.0	94.0	143.0	140	3.0	18	3
16.8	3	<input type="checkbox"/>	MNS1680S-DIN	47.9	73.1	74.1	123.1	120	3.1	18	4
	3	<input type="checkbox"/>	MNS1680S-DIN-C	47.9	73.1	74.1	123.1	120	3.1	18	3
	5	<input type="checkbox"/>	MNS1680L-DIN	67.9	93.1	94.1	143.1	140	3.1	18	4
	5	<input type="checkbox"/>	MNS1680L-DIN-C	67.9	93.1	94.1	143.1	140	3.1	18	3
16.9	3	<input type="checkbox"/>	MNS1690S-DIN	47.7	73.1	74.1	123.1	120	3.1	18	4
	3	<input type="checkbox"/>	MNS1690S-DIN-C	47.7	73.1	74.1	123.1	120	3.1	18	3
	5	<input type="checkbox"/>	MNS1690L-DIN	67.7	93.1	94.1	143.1	140	3.1	18	4
	5	<input type="checkbox"/>	MNS1690L-DIN-C	67.7	93.1	94.1	143.1	140	3.1	18	3
17.0	3	<input type="checkbox"/>	MNS1700S-DIN	47.6	73.1	74.1	123.1	120	3.1	18	4
	3	<input type="checkbox"/>	MNS1700S-DIN-C	47.6	73.1	74.1	123.1	120	3.1	18	3
	5	<input type="checkbox"/>	MNS1700L-DIN	67.6	93.1	94.1	143.1	140	3.1	18	4
	5	<input checked="" type="checkbox"/>	MNS1700L-DIN-C	67.6	93.1	94.1	143.1	140	3.1	18	3
17.1	3	<input type="checkbox"/>	MNS1710S-DIN	47.5	73.1	74.1	123.1	120	3.1	18	4
	3	<input type="checkbox"/>	MNS1710S-DIN-C	47.5	73.1	74.1	123.1	120	3.1	18	3
	5	<input type="checkbox"/>	MNS1710L-DIN	67.5	93.1	94.1	143.1	140	3.1	18	4
	5	<input type="checkbox"/>	MNS1710L-DIN-C	67.5	93.1	94.1	143.1	140	3.1	18	3
17.2	3	<input type="checkbox"/>	MNS1720S-DIN	47.3	73.1	74.1	123.1	120	3.1	18	4
	3	<input type="checkbox"/>	MNS1720S-DIN-C	47.3	73.1	74.1	123.1	120	3.1	18	3
	5	<input type="checkbox"/>	MNS1720L-DIN	67.3	93.1	94.1	143.1	140	3.1	18	4
	5	<input type="checkbox"/>	MNS1720L-DIN-C	67.3	93.1	94.1	143.1	140	3.1	18	3
17.3	3	<input type="checkbox"/>	MNS1730S-DIN	47.2	73.1	74.1	123.1	120	3.1	18	4
	3	<input type="checkbox"/>	MNS1730S-DIN-C	47.2	73.1	74.1	123.1	120	3.1	18	3
	5	<input type="checkbox"/>	MNS1730L-DIN	67.2	93.1	94.1	143.1	140	3.1	18	4
	5	<input type="checkbox"/>	MNS1730L-DIN-C	67.2	93.1	94.1	143.1	140	3.1	18	3
17.4	3	<input type="checkbox"/>	MNS1740S-DIN	47.1	73.2	74.2	123.2	120	3.2	18	4
	3	<input type="checkbox"/>	MNS1740S-DIN-C	47.1	73.2	74.2	123.2	120	3.2	18	3
	5	<input type="checkbox"/>	MNS1740L-DIN	67.1	93.2	94.2	143.2	140	3.2	18	4
	5	<input type="checkbox"/>	MNS1740L-DIN-C	67.1	93.2	94.2	143.2	140	3.2	18	3
17.5	3	<input type="checkbox"/>	MNS1750S-DIN	46.9	73.2	74.2	123.2	120	3.2	18	4
	3	<input type="checkbox"/>	MNS1750S-DIN-C	46.9	73.2	74.2	123.2	120	3.2	18	3
	5	<input type="checkbox"/>	MNS1750L-DIN	66.9	93.2	94.2	143.2	140	3.2	18	4
	5	<input checked="" type="checkbox"/>	MNS1750L-DIN-C	66.9	93.2	94.2	143.2	140	3.2	18	3
17.6	3	<input type="checkbox"/>	MNS1760S-DIN	46.8	73.2	74.2	123.2	120	3.2	18	4
	3	<input type="checkbox"/>	MNS1760S-DIN-C	46.8	73.2	74.2	123.2	120	3.2	18	3
	5	<input type="checkbox"/>	MNS1760L-DIN	66.8	93.2	94.2	143.2	140	3.2	18	4
	5	<input type="checkbox"/>	MNS1760L-DIN-C	66.8	93.2	94.2	143.2	140	3.2	18	3

Примечание 1) Пожалуйста, свяжитесь с нами если Вы не нашли нужную геометрию в данном каталоге (могут быть заказаны другие диаметры и длины).

● : Есть на складе. □ : Нет на складе, выпускается исключительно под заказ.

DC (мм)	Глубина сверления (L/D)	TF15	Обозначение	Размеры (мм)							Тип
				LU	LCF	LH	OAL	LF	PL	DCON	
17.7	3	□	MNS1770S-DIN	46.7	73.2	74.2	123.2	120	3.2	18	4
	3	□	MNS1770S-DIN-C	46.7	73.2	74.2	123.2	120	3.2	18	3
	5	□	MNS1770L-DIN	66.7	93.2	94.2	143.2	140	3.2	18	4
	5	□	MNS1770L-DIN-C	66.7	93.2	94.2	143.2	140	3.2	18	3
17.8	3	□	MNS1780S-DIN	46.5	73.2	74.2	123.2	120	3.2	18	4
	3	□	MNS1780S-DIN-C	46.5	73.2	74.2	123.2	120	3.2	18	3
	5	□	MNS1780L-DIN	66.5	93.2	94.2	143.2	140	3.2	18	4
	5	□	MNS1780L-DIN-C	66.5	93.2	94.2	143.2	140	3.2	18	3
17.9	3	□	MNS1790S-DIN	46.4	73.3	74.3	123.3	120	3.3	18	4
	3	□	MNS1790S-DIN-C	46.4	73.3	74.3	123.3	120	3.3	18	3
	5	□	MNS1790L-DIN	66.4	93.3	94.3	143.3	140	3.3	18	4
	5	□	MNS1790L-DIN-C	66.4	93.3	94.3	143.3	140	3.3	18	3
18.0	3	□	MNS1800S-DIN	46.3	73.3	74.3	123.3	120	3.3	18	4
	3	□	MNS1800S-DIN-C	46.3	73.3	74.3	123.3	120	3.3	18	3
	5	□	MNS1800L-DIN	66.3	93.3	94.3	143.3	140	3.3	18	4
	5	●	MNS1800L-DIN-C	66.3	93.3	94.3	143.3	140	3.3	18	3
18.1	3	□	MNS1810S-DIN	52.1	79.3	80.3	131.3	128	3.3	20	4
	3	□	MNS1810S-DIN-C	52.1	79.3	80.3	131.3	128	3.3	20	3
	5	□	MNS1810L-DIN	74.1	101.3	102.3	153.3	150	3.3	20	4
	5	□	MNS1810L-DIN-C	74.1	101.3	102.3	153.3	150	3.3	20	3
18.2	3	□	MNS1820S-DIN	52.0	79.3	80.3	131.3	128	3.3	20	4
	3	□	MNS1820S-DIN-C	52.0	79.3	80.3	131.3	128	3.3	20	3
	5	□	MNS1820L-DIN	74.0	101.3	102.3	153.3	150	3.3	20	4
	5	□	MNS1820L-DIN-C	74.0	101.3	102.3	153.3	150	3.3	20	3
18.3	3	□	MNS1830S-DIN	51.9	79.3	80.3	131.3	128	3.3	20	4
	3	□	MNS1830S-DIN-C	51.9	79.3	80.3	131.3	128	3.3	20	3
	5	□	MNS1830L-DIN	73.9	101.3	102.3	153.3	150	3.3	20	4
	5	□	MNS1830L-DIN-C	73.9	101.3	102.3	153.3	150	3.3	20	3
18.4	3	□	MNS1840S-DIN	51.7	79.3	80.3	131.3	128	3.3	20	4
	3	□	MNS1840S-DIN-C	51.7	79.3	80.3	131.3	128	3.3	20	3
	5	□	MNS1840L-DIN	73.7	101.3	102.3	153.3	150	3.3	20	4
	5	□	MNS1840L-DIN-C	73.7	101.3	102.3	153.3	150	3.3	20	3
18.5	3	□	MNS1850S-DIN	51.6	79.4	80.4	131.4	128	3.4	20	4
	3	□	MNS1850S-DIN-C	51.6	79.4	80.4	131.4	128	3.4	20	3
	5	□	MNS1850L-DIN	73.6	101.4	102.4	153.4	150	3.4	20	4
	5	●	MNS1850L-DIN-C	73.6	101.4	102.4	153.4	150	3.4	20	3
18.6	3	□	MNS1860S-DIN	51.5	79.4	80.4	131.4	128	3.4	20	4
	3	□	MNS1860S-DIN-C	51.5	79.4	80.4	131.4	128	3.4	20	3
	5	□	MNS1860L-DIN	73.5	101.4	102.4	153.4	150	3.4	20	4
	5	□	MNS1860L-DIN-C	73.5	101.4	102.4	153.4	150	3.4	20	3
18.7	3	□	MNS1870S-DIN	51.4	79.4	80.4	131.4	128	3.4	20	4
	3	□	MNS1870S-DIN-C	51.4	79.4	80.4	131.4	128	3.4	20	3
	5	□	MNS1870L-DIN	73.4	101.4	102.4	153.4	150	3.4	20	4
	5	□	MNS1870L-DIN-C	73.4	101.4	102.4	153.4	150	3.4	20	3
18.8	3	□	MNS1880S-DIN	51.2	79.4	80.4	131.4	128	3.4	20	4
	3	□	MNS1880S-DIN-C	51.2	79.4	80.4	131.4	128	3.4	20	3
	5	□	MNS1880L-DIN	73.2	101.4	102.4	153.4	150	3.4	20	4
	5	□	MNS1880L-DIN-C	73.2	101.4	102.4	153.4	150	3.4	20	3

DC (мм)	Глубина сверления (L/D)	TF15	Обозначение	Размеры (мм)							Тип
				LU	LCF	LH	OAL	LF	PL	DCON	
18.9	3	□	MNS1890S-DIN	51.1	79.4	80.4	131.4	128	3.4	20	4
	3	□	MNS1890S-DIN-C	51.1	79.4	80.4	131.4	128	3.4	20	3
	5	□	MNS1890L-DIN	73.1	101.4	102.4	153.4	150	3.4	20	4
	5	□	MNS1890L-DIN-C	73.1	101.4	102.4	153.4	150	3.4	20	3
19.0	3	□	MNS1900S-DIN	51.0	79.5	80.5	131.5	128	3.5	20	4
	3	□	MNS1900S-DIN-C	51.0	79.5	80.5	131.5	128	3.5	20	3
	5	□	MNS1900L-DIN	73.0	101.5	102.5	153.5	150	3.5	20	4
	5	□	MNS1900L-DIN-C	73.0	101.5	102.5	153.5	150	3.5	20	3
19.1	3	□	MNS1910S-DIN	50.8	79.5	80.5	131.5	128	3.5	20	4
	3	□	MNS1910S-DIN-C	50.8	79.5	80.5	131.5	128	3.5	20	3
	5	□	MNS1910L-DIN	72.8	101.5	102.5	153.5	150	3.5	20	4
	5	□	MNS1910L-DIN-C	72.8	101.5	102.5	153.5	150	3.5	20	3
19.2	3	□	MNS1920S-DIN	50.7	79.5	80.5	131.5	128	3.5	20	4
	3	□	MNS1920S-DIN-C	50.7	79.5	80.5	131.5	128	3.5	20	3
	5	□	MNS1920L-DIN	72.7	101.5	102.5	153.5	150	3.5	20	4
	5	□	MNS1920L-DIN-C	72.7	101.5	102.5	153.5	150	3.5	20	3
19.3	3	□	MNS1930S-DIN	50.6	79.5	80.5	131.5	128	3.5	20	4
	5	□	MNS1930L-DIN	72.6	101.5	102.5	153.5	150	3.5	20	4
	5	□	MNS1930L-DIN-C	72.6	101.5	102.5	153.5	150	3.5	20	3
	19.4	3	□	MNS1940S-DIN	50.4	79.5	80.5	131.5	128	3.5	20
3		□	MNS1940S-DIN-C	50.4	79.5	80.5	131.5	128	3.5	20	3
5		□	MNS1940L-DIN	72.4	101.5	102.5	153.5	150	3.5	20	4
5		□	MNS1940L-DIN-C	72.4	101.5	102.5	153.5	150	3.5	20	3
19.5	3	□	MNS1950S-DIN	50.3	79.5	80.5	131.5	128	3.5	20	4
	3	□	MNS1950S-DIN-C	50.3	79.5	80.5	131.5	128	3.5	20	3
	5	□	MNS1950L-DIN	72.3	101.5	102.5	153.5	150	3.5	20	4
	5	●	MNS1950L-DIN-C	72.3	101.5	102.5	153.5	150	3.5	20	3
19.6	3	□	MNS1960S-DIN	50.2	79.6	80.6	131.6	128	3.6	20	4
	3	□	MNS1960S-DIN-C	50.2	79.6	80.6	131.6	128	3.6	20	3
	5	□	MNS1960L-DIN	72.2	101.6	102.6	153.6	150	3.6	20	4
	5	□	MNS1960L-DIN-C	72.2	101.6	102.6	153.6	150	3.6	20	3
19.7	3	□	MNS1970S-DIN	50.0	79.6	80.6	131.6	128	3.6	20	4
	3	□	MNS1970S-DIN-C	50.0	79.6	80.6	131.6	128	3.6	20	3
	5	□	MNS1970L-DIN	72.0	101.6	102.6	153.6	150	3.6	20	4
	5	□	MNS1970L-DIN-C	72.0	101.6	102.6	153.6	150	3.6	20	3
19.8	3	□	MNS1980S-DIN	49.9	79.6	80.6	131.6	128	3.6	20	4
	3	□	MNS1980S-DIN-C	49.9	79.6	80.6	131.6	128	3.6	20	3
	5	□	MNS1980L-DIN	71.9	101.6	102.6	153.6	150	3.6	20	4
	5	□	MNS1980L-DIN-C	71.9	101.6	102.6	153.6	150	3.6	20	3
19.9	3	□	MNS1990S-DIN	49.8	79.6	80.6	131.6	128	3.6	20	4
	3	□	MNS1990S-DIN-C	49.8	79.6	80.6	131.6	128	3.6	20	3
	5	□	MNS1990L-DIN	71.8	101.6	102.6	153.6	150	3.6	20	4
	5	□	MNS1990L-DIN-C	71.8	101.6	102.6	153.6	150	3.6	20	3
20.0	3	□	MNS2000S-DIN	49.6	79.6	80.6	131.6	128	3.6	20	4
	3	□	MNS2000S-DIN-C	49.6	79.6	80.6	131.6	128	3.6	20	3
	5	□	MNS2000L-DIN	71.6	101.6	102.6	153.6	150	3.6	20	4
	5	●	MNS2000L-DIN-C	71.6	101.6	102.6	153.6	150	3.6	20	3

РЕКОМЕНДУЕМЫЕ РЕЖИМЫ РЕЗАНИЯ

■ Глубина сверления : L/D = 3, 5, 8 (Тип LB, S-DIN, S-DIN-C, L-DIN, L-DIN-C, L8C)

Обрабатываемый материал	N					
	Алюминиевые сплавы (Si<5%)		Алюминиевые сплавы (5%≤Si≤10%)		Алюминиевые сплавы (Si>10%)	
Диам. сверла DC (мм)	Частота вращения (мин ⁻¹)	Подача (мин. — макс.) (мм/об)	Частота вращения (мин ⁻¹)	Подача (мин. — макс.) (мм/об)	Частота вращения (мин ⁻¹)	Подача (мин. — макс.) (мм/об)
3.2	11900	0.1 (0.11—0.16)	11900	0.15 (0.16—0.21)	11900	0.15 (0.16—0.21)
4.0	9500	0.15 (0.13—0.20)	9500	0.2 (0.20—0.27)	9500	0.2 (0.20—0.27)
5.0	7600	0.2 (0.17—0.25)	7600	0.25 (0.25—0.33)	7600	0.25 (0.25—0.33)
6.3	7500	0.25 (0.21—0.32)	7500	0.35 (0.32—0.42)	7500	0.35 (0.32—0.42)
8.0	5900	0.3 (0.27—0.40)	5900	0.45 (0.40—0.53)	5900	0.45 (0.40—0.53)
10.0	4700	0.4 (0.33—0.50)	4700	0.55 (0.50—0.67)	4700	0.55 (0.50—0.67)
12.0	5300	0.5 (0.40—0.60)	5300	0.7 (0.60—0.80)	5300	0.7 (0.60—0.80)
14.0	4500	0.5 (0.40—0.60)	4500	0.7 (0.60—0.80)	4500	0.7 (0.60—0.80)
16.0	4000	0.5 (0.40—0.60)	4000	0.7 (0.60—0.80)	4000	0.7 (0.60—0.80)
18.0	3500	0.5 (0.40—0.60)	3500	0.7 (0.60—0.80)	3500	0.7 (0.60—0.80)
20.0	3200	0.5 (0.40—0.60)	3200	0.7 (0.60—0.80)	3200	0.7 (0.60—0.80)

Примечание 1) При сверлении отверстий с глубиной сверления свыше L/D=10 рекомендуется сначала просверлить направляющее отверстие. (В противном случае возможна поломка сверла.)

Примечание 2) Для предварительного сверления рекомендуются сверла Mitsubishi MNS, MAE-MB или MAS-MB.

■ Глубина сверления : L/D = 10, 12, 15, 20, 25, 30 (Тип X10DB, X20DB, X30DB, L10C, L12C, L15C, L20C, L25C, L30C)

Обрабатываемый материал	N					
	Алюминиевые сплавы (Si<5%)		Алюминиевые сплавы (5%≤Si≤10%)		Алюминиевые сплавы (Si>10%)	
Диам. сверла DC (мм)	Частота вращения (мин ⁻¹)	Подача (мин. — макс.) (мм/об)	Частота вращения (мин ⁻¹)	Подача (мин. — макс.) (мм/об)	Частота вращения (мин ⁻¹)	Подача (мин. — макс.) (мм/об)
3.2	8900	0.1 (0.11—0.16)	8900	0.15 (0.16—0.21)	8900	0.15 (0.16—0.21)
4.0	7100	0.15 (0.13—0.20)	7100	0.2 (0.20—0.27)	7100	0.2 (0.20—0.27)
5.0	5700	0.2 (0.17—0.25)	5700	0.25 (0.25—0.33)	5700	0.25 (0.25—0.33)
6.3	6000	0.25 (0.21—0.32)	6000	0.35 (0.32—0.42)	6000	0.35 (0.32—0.42)
8.0	4700	0.3 (0.27—0.40)	4700	0.45 (0.40—0.53)	4700	0.45 (0.40—0.53)
10.0	3800	0.4 (0.33—0.50)	3800	0.55 (0.50—0.67)	3800	0.55 (0.50—0.67)
12.0	4200	0.5 (0.40—0.60)	4200	0.7 (0.60—0.80)	4200	0.7 (0.60—0.80)
14.0	3600	0.5 (0.40—0.60)	3600	0.7 (0.60—0.80)	3600	0.7 (0.60—0.80)
16.0	3200	0.5 (0.40—0.60)	3200	0.7 (0.60—0.80)	3200	0.7 (0.60—0.80)
18.0	2800	0.5 (0.40—0.60)	2800	0.7 (0.60—0.80)	2800	0.7 (0.60—0.80)
20.0	2500	0.5 (0.40—0.60)	2500	0.7 (0.60—0.80)	2500	0.7 (0.60—0.80)

Примечание 1) При сверлении отверстий с глубиной сверления свыше L/D=10 рекомендуется сначала просверлить направляющее отверстие. (В противном случае возможна поломка сверла.)

Примечание 2) Для предварительного сверления рекомендуются сверла Mitsubishi MNS, MAE-MB или MAS-MB.

■ УКАЗАНИЯ ПО ЭКСПЛУАТАЦИИ СЕРИИ MNS (L/D 3, 5, 8)

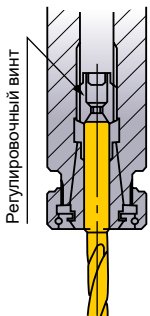
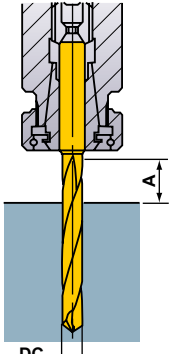
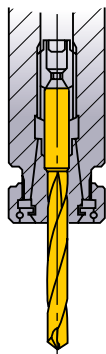
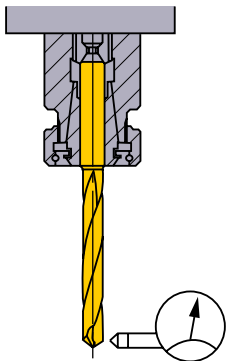
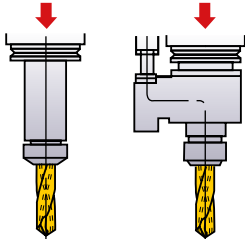
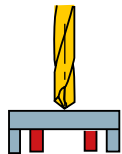
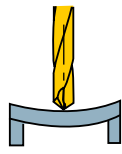
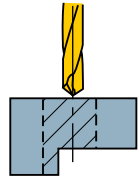
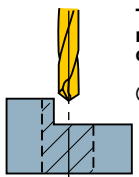
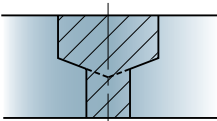
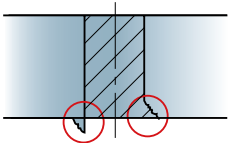
<p>Крепление сверла</p>  <p>Цанговый патрон с упорным подшипником надежно держит сверло.</p>	<p>Длина сверла</p>  <p>$A : \geq DC \times 1.5$</p>	<p>Установка сверла</p>  <p>Не прижимать по режущей кромке.</p>	<p>Допуск на установку</p>  <p>Биение $\leq 0.03\text{мм}$</p>
<p>Метод охлаждения (MNS)</p>  <p>Тип охлаждения через шпиндель Тип охлаждения на вращающийся шпиндель станка</p> <p>Давление СОЖ приблизительно. 5 Бар—70 Бар</p>	<p>Рекомендации по использованию СОЖ</p> <p><Тип MNS></p> <ol style="list-style-type: none"> 1) Рекомендуется регулярно проводить замену СОЖ во избежании забивания каналов в сверле. 2) Для предотвращения забивания мелкой стружкой отверстий сверла используйте фильтр, как профилактическую меру. Для сверл малого диаметра рекомендуется применять фильтр с более мелкими ячейками. 	<p>Тонкая заготовка</p>  <p>OK Необходима опора для заготовки.</p>  <p>X Если наблюдается отгиб.</p>	<p>Прерывистое резание</p>  <p>Один процесс OK</p> <p>① Уменьшить подачу при сверлении ступенчатой детали (при прерывистом сверлении).</p>  <p>Требуется предварительная обработка.</p> <p>① До сверления предварительно подрезать торец концевой фрезой.</p>
<p>Ступенчатые отверстия.</p>  <ol style="list-style-type: none"> ① Разделите операцию на два перехода. ② Сначала просверлите отверстие большего диаметра. <p>*Инструменты для снятия фаски и цекования могут быть изготовлены по заказу.</p>	<p>Образование заусенцев и выкрашивание заготовки.</p>  <ol style="list-style-type: none"> ① На выходе сверла из отверстия снизьте подачу. ② Снять фаску. ③ Измените угол при вершине. 		

■ УКАЗАНИЯ ПО ЭКСПЛУАТАЦИИ ДЛИННОЙ СЕРИИ MNS (L/D 10, 12, 15, 20, 25, 30)

СВЕРЛЕНИЕ НА ПЛОСКИХ ПОВЕРХНОСТЯХ ● Сделать глухое отверстие

■ 1. Выполнить направляющее отверстие

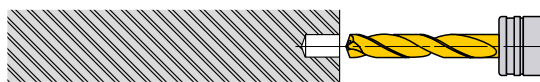

- ① Для выполнения направляющего отверстия мы рекомендуем использовать сверла фирмы Mitsubishi типа MNS, MAE-MB или MAS-MB.
- ② Используйте сверло такого же диаметра, как и для обработки глубоких отверстий.
- ③ Направляющее отверстие : мин. 1DC или глубже
(Выберите глубину направляющего отверстия, соответствующую длине сверхдлинного сверла.)

■ 2. Предварительная обработка при помощи длинного сверла



- ① Вход в направляющее отверстие с малой частотой вращения.
(Скорость резания 20—30 м/мин, подача 0.2—0.3 мм/об)
- ② Остановить сверло для глубоких отверстий 1—3 мм до достижения дна направляющего отверстия.

■ 3. Сверление глубокого отверстия

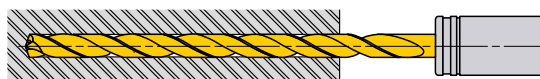

- ① Увеличьте частоту вращения и подачу за цикл и просверлите до желаемой глубины.

■ 4. Выведите сверло

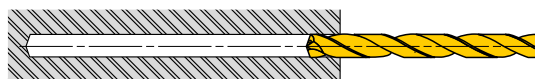

- ① После просверливания, примерно на 1—2 мм до конца отверстия, уменьшить скорость резания (скорость резания 20—30 м/мин.)
- ② Выньте сверло примерно до глубины направляющего отверстия (Vf=3000мм/мин.)
- ③ Выведите сверло из направляющего отверстия с уменьшенной частотой вращения (n=300, Vf=3000мм/мин)

СВЕРЛЕНИЕ НА НАКЛОННЫХ ПОВЕРХНОСТЯХ ● Отверстия на изогнутых заготовках

■ 1. Фрезерование плоских поверхностей



- ① При обработке глубокого отверстия на наклонной поверхности используйте сверло MFE в качестве сверла для направляющего отверстия.
- ② Убедитесь, что для направляющей просверлено высокоточное отверстие.
- ③ Глубина сверления: приблизительно DC×1.

■ 2. Выполнить направляющее отверстие

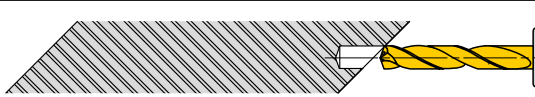

- ① Для выполнения направляющего отверстия мы рекомендуем использовать сверла фирмы Mitsubishi типа MNS, MAE-MB или MAS-MB.
- ② Используйте сверло такого же диаметра, как и для обработки глубоких отверстий.
- ③ Направляющее отверстие : мин. 1DC или глубже
(Выберите глубину направляющего отверстия, соответствующую длине сверхдлинного сверла.)

■ 3. Предварительная обработка при помощи длинного сверла

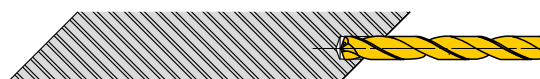

- ① Вход в направляющее отверстие с малой частотой вращения.
(Скорость резания 20—30 м/мин, подача 0.2—0.3 мм/об)
- ② Остановить сверло для глубоких отверстий 1—3 мм до достижения дна направляющего отверстия.

■ 4. Сверление глубокого отверстия

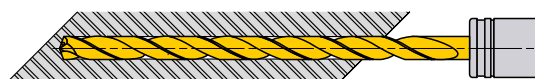

- ① Увеличьте частоту вращения и подачу за цикл и просверлите до желаемой глубины.

■ 5. Проходные отверстия



- ① При выходе из заготовки режущая кромка сверла может обломиться.
- ② Уменьшите подачу до Vf=0.05мм—0.1мм/об.

■ 6. Выведите сверло



- ① Поднимите сверло из направляющего отверстия до глубины начальной точки с подачей 3000мм/мин.
- ② Обработайте отверстие со скоростью резания 20—30м/мин и подачей 0.2—0.3мм/об.

ИНСТРУМЕНТ ДЛЯ СВЕРЛЕНИЯ (МОНОЛИТНЫЕ ТВЕРДОСПЛАВНЫЕ СВЕРЛА)

MAE, MAS

- Применяется для сверления алюминиевых сплавов и чугунов.
- Высокая точность получаемого отверстия.
- Предварительное сверление для резьбового отверстия.
- Винтовые каналы для внутреннего охлаждения дают возможность использовать высокоскоростную обработку (сверла типа MAS).



Только MAS

ТВЕРДЫЙ СПЛАВ



MAE (Наружное охлаждение)



MAS (Внутреннее охлаждение)



Примечание 1) Сверла типа MAS диаметром более $\phi 5.0$ мм имеют углубление на торце.

Примечание 2) Сверла MAE/MAS предназначены для использования с термоматрицами.



DC=3	3<DC≤6	6<DC≤10	10<DC≤16
+0.005 0	+0.005 0	+0.005 0	+0.005 0
0 -0.006	0 -0.008	0 -0.009	0 -0.011

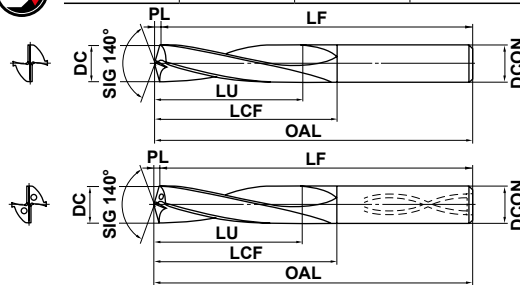

ИНСТРУМЕНТ ДЛЯ СВЕРЛЕНИЯ

M

DC (мм)	Глубина сверления (L/D)	Охлаждение (Внут./Нар.)	HT110	Обозначение	Размеры (мм)					
					LU	LCF	OAL	LF	PL	DCON
3.0	3	Нар.	★	MAE0300MB	9.5	21.5	61.5	61	0.5	3
	3	Внут.	□	MAS0300MB	9.5	21.5	61.5	61	0.5	3
	6	Внут.	●	MAS0300LB	18.5	30.5	70.5	70	0.5	3
3.1	3	Нар.	★	MAE0310MB	9.9	24.6	64.6	64	0.6	4
	3	Внут.	□	MAS0310MB	9.9	24.6	64.6	64	0.6	4
	6	Внут.	★	MAS0310LB	19.2	34.6	74.6	74	0.6	4
3.2	3	Нар.	★	MAE0320MB	10.2	24.6	64.6	64	0.6	4
	3	Внут.	□	MAS0320MB	10.2	24.6	64.6	64	0.6	4
	6	Внут.	★	MAS0320LB	19.8	34.6	74.6	74	0.6	4
3.3	3	Нар.	★	MAE0330MB	10.5	24.6	64.6	64	0.6	4
	3	Внут.	□	MAS0330MB	10.5	24.6	64.6	64	0.6	4
	6	Внут.	●	MAS0330LB	20.4	34.6	74.6	74	0.6	4
3.4	3	Нар.	★	MAE0340MB	10.8	24.6	64.6	64	0.6	4
	3	Внут.	□	MAS0340MB	10.8	24.6	64.6	64	0.6	4
	6	Внут.	★	MAS0340LB	21.0	34.6	74.6	74	0.6	4
3.5	3	Нар.	★	MAE0350MB	11.1	24.6	64.6	64	0.6	4
	3	Внут.	□	MAS0350MB	11.1	24.6	64.6	64	0.6	4
	6	Внут.	●	MAS0350LB	21.6	34.6	74.6	74	0.6	4
3.6	3	Нар.	★	MAE0360MB	11.5	28.7	68.7	68	0.7	4
	3	Внут.	□	MAS0360MB	11.5	28.7	68.7	68	0.7	4
	6	Внут.	★	MAS0360LB	22.3	40.7	80.7	80	0.7	4
3.65	3	Нар.	★	* MAE0365MB	11.7	28.7	68.7	68	0.7	4
	3	Внут.	□	* MAS0365MB	11.7	28.7	68.7	68	0.7	4
	6	Внут.	●	* MAS0365LB	22.6	40.7	80.7	80	0.7	4
3.7	3	Нар.	★	MAE0370MB	11.8	28.7	68.7	68	0.7	4
	3	Внут.	□	MAS0370MB	11.8	28.7	68.7	68	0.7	4
	6	Внут.	★	MAS0370LB	22.9	40.7	80.7	80	0.7	4
3.8	3	Нар.	★	MAE0380MB	12.1	28.7	68.7	68	0.7	4
	3	Внут.	□	MAS0380MB	12.1	28.7	68.7	68	0.7	4
	6	Внут.	★	MAS0380LB	23.5	40.7	80.7	80	0.7	4
3.9	3	Нар.	★	MAE0390MB	12.4	28.7	68.7	68	0.7	4
	3	Внут.	□	MAS0390MB	12.4	28.7	68.7	68	0.7	4
	6	Внут.	★	MAS0390LB	24.1	40.7	80.7	80	0.7	4
4.0	3	Нар.	★	MAE0400MB	12.7	28.7	68.7	68	0.7	4
	3	Внут.	□	MAS0400MB	12.7	28.7	68.7	68	0.7	4
	6	Внут.	●	MAS0400LB	24.7	40.7	80.7	80	0.7	4
4.1	3	Нар.	★	MAE0410MB	13.0	31.7	71.7	71	0.7	5
	3	Внут.	□	MAS0410MB	13.0	31.7	71.7	71	0.7	5
	6	Внут.	★	MAS0410LB	25.3	44.7	84.7	84	0.7	5

DC (мм)	Глубина сверления (L/D)	Охлаждение (Внут./Нар.)	HT110	Обозначение	Размеры (мм)					
					LU	LCF	OAL	LF	PL	DCON
4.2	3	Нар.	★	MAE0420MB	13.4	31.8	71.8	71	0.8	5
	3	Внут.	□	MAS0420MB	13.4	31.8	71.8	71	0.8	5
	6	Внут.	●	MAS0420LB	26.0	44.8	84.8	84	0.8	5
4.3	3	Нар.	★	MAE0430MB	13.7	31.8	71.8	71	0.8	5
	3	Внут.	□	MAS0430MB	13.7	31.8	71.8	71	0.8	5
	6	Внут.	★	MAS0430LB	26.6	44.8	84.8	84	0.8	5
4.4	3	Нар.	★	MAE0440MB	14.0	31.8	71.8	71	0.8	5
	3	Внут.	□	MAS0440MB	14.0	31.8	71.8	71	0.8	5
	6	Внут.	★	MAS0440LB	27.2	44.8	84.8	84	0.8	5
4.5	3	Нар.	★	MAE0450MB	14.3	31.8	71.8	71	0.8	5
	3	Внут.	□	MAS0450MB	14.3	31.8	71.8	71	0.8	5
	6	Внут.	★	MAS0450LB	27.8	44.8	84.8	84	0.8	5
4.6	3	Нар.	★	* MAE0460MB	14.6	33.8	73.8	73	0.8	5
	3	Внут.	□	* MAS0460MB	14.6	33.8	73.8	73	0.8	5
	6	Внут.	●	* MAS0460LB	28.4	48.8	88.8	88	0.8	5
4.7	3	Нар.	★	MAE0470MB	15.0	33.9	73.9	73	0.9	5
	3	Внут.	□	MAS0470MB	15.0	33.9	73.9	73	0.9	5
	6	Внут.	★	MAS0470LB	29.1	48.9	88.9	88	0.9	5
4.8	3	Нар.	★	MAE0480MB	15.3	33.9	73.9	73	0.9	5
	3	Внут.	□	MAS0480MB	15.3	33.9	73.9	73	0.9	5
	6	Внут.	★	MAS0480LB	29.7	48.9	88.9	88	0.9	5
4.9	3	Нар.	★	MAE0490MB	15.6	33.9	73.9	73	0.9	5
	3	Внут.	□	MAS0490MB	15.6	33.9	73.9	73	0.9	5
	6	Внут.	★	MAS0490LB	30.3	48.9	88.9	88	0.9	5
5.0	3	Нар.	★	MAE0500MB	15.9	33.9	73.9	73	0.9	5
	3	Внут.	●	MAS0500MB	15.9	33.9	73.9	73	0.9	5
	6	Внут.	●	MAS0500LB	30.9	48.9	88.9	88	0.9	5
5.1	3	Нар.	★	MAE0510MB	16.2	36.9	76.9	76	0.9	6
	3	Внут.	□	MAS0510MB	16.2	36.9	76.9	76	0.9	6
	6	Внут.	★	MAS0510LB	31.5	52.9	92.9	92	0.9	6
5.2	3	Нар.	★	MAE0520MB	16.5	36.9	76.9	76	0.9	6
	3	Внут.	□	MAS0520MB	16.5	36.9	76.9	76	0.9	6
	6	Внут.	●	MAS0520LB	32.1	52.9	92.9	92	0.9	6
5.3	3	Нар.	★	MAE0530MB	16.9	37.0	77.0	76	1.0	6
	3	Внут.	□	MAS0530MB	16.9	37.0	77.0	76	1.0	6
	6	Внут.	★	MAS0530LB	32.8	53.0	93.0	92	1.0	6
5.4	3	Нар.	★	MAE0540MB	17.2	37.0	77.0	76	1.0	6
	3	Внут.	□	MAS0540MB	17.2	37.0	77.0	76	1.0	6
	6	Внут.	★	MAS0540LB	33.4	53.0	93.0	92	1.0	6

* : Стандартные размеры отверстий для резбонакатных метчиков.

● : Есть на складе. ★ : Со склада в Японии.

□ : Нет на складе, выпускается исключительно под заказ.

DC (мм)	Глубина сверления (L/D)	Охлаждение (Внут./Нар.)	НТИ10	Обозначение	Размеры (мм)					
					LU	LCF	OAL	LF	PL	DCON
5.5	3	Нар.	★	* MAE0550MB	17.5	37.0	77.0	76	1.0	6
	3	Внут.	★	* MAS0550MB	17.5	37.0	77.0	76	1.0	6
	6	Внут.	●	* MAS0550LB	34.0	53.0	93.0	92	1.0	6
5.6	3	Нар.	★	MAE0560MB	17.8	40.0	80.0	79	1.0	6
	3	Внут.	□	MAS0560MB	17.8	40.0	80.0	79	1.0	6
	6	Внут.	★	MAS0560LB	34.6	58.0	98.0	97	1.0	6
5.7	3	Нар.	★	MAE0570MB	18.1	40.0	80.0	79	1.0	6
	3	Внут.	□	MAS0570MB	18.1	40.0	80.0	79	1.0	6
	6	Внут.	★	MAS0570LB	35.2	58.0	98.0	97	1.0	6
5.8	3	Нар.	★	MAE0580MB	18.5	40.1	80.1	79	1.1	6
	3	Внут.	□	MAS0580MB	18.5	40.1	80.1	79	1.1	6
	6	Внут.	★	MAS0580LB	35.9	58.1	98.1	97	1.1	6
5.9	3	Нар.	★	MAE0590MB	18.8	40.1	80.1	79	1.1	6
	3	Внут.	□	MAS0590MB	18.8	40.1	80.1	79	1.1	6
	6	Внут.	★	MAS0590LB	36.5	58.1	98.1	97	1.1	6
6.0	3	Нар.	★	MAE0600MB	19.1	40.1	80.1	79	1.1	6
	3	Внут.	●	MAS0600MB	19.1	40.1	80.1	79	1.1	6
	6	Внут.	●	MAS0600LB	37.1	58.1	98.1	97	1.1	6
6.1	3	Нар.	★	MAE0610MB	19.4	43.1	85.1	84	1.1	7
	3	Внут.	□	MAS0610MB	19.4	43.1	85.1	84	1.1	7
	6	Внут.	★	MAS0610LB	37.7	63.1	105.1	104	1.1	7
6.2	3	Нар.	★	MAE0620MB	19.7	43.1	85.1	84	1.1	7
	3	Внут.	□	MAS0620MB	19.7	43.1	85.1	84	1.1	7
	6	Внут.	★	MAS0620LB	38.3	63.1	105.1	104	1.1	7
6.3	3	Нар.	★	MAE0630MB	20.0	43.1	85.1	84	1.1	7
	3	Внут.	□	MAS0630MB	20.0	43.1	85.1	84	1.1	7
	6	Внут.	★	MAS0630LB	38.9	63.1	105.1	104	1.1	7
6.4	3	Нар.	★	MAE0640MB	20.4	43.2	85.2	84	1.2	7
	3	Внут.	□	MAS0640MB	20.4	43.2	85.2	84	1.2	7
	6	Внут.	★	MAS0640LB	39.6	63.2	105.2	104	1.2	7
6.5	3	Нар.	★	MAE0650MB	20.7	43.2	85.2	84	1.2	7
	3	Внут.	★	MAS0650MB	20.7	43.2	85.2	84	1.2	7
	6	Внут.	●	MAS0650LB	40.2	63.2	105.2	104	1.2	7
6.6	3	Нар.	★	MAE0660MB	21.0	43.2	85.2	84	1.2	7
	3	Внут.	□	MAS0660MB	21.0	43.2	85.2	84	1.2	7
	6	Внут.	★	MAS0660LB	40.8	66.2	108.2	107	1.2	7
6.7	3	Нар.	★	MAE0670MB	21.3	43.2	85.2	84	1.2	7
	3	Внут.	□	MAS0670MB	21.3	43.2	85.2	84	1.2	7
	6	Внут.	●	MAS0670LB	41.4	66.2	108.2	107	1.2	7
6.8	3	Нар.	★	MAE0680MB	21.6	43.2	85.2	84	1.2	7
	3	Внут.	★	MAS0680MB	21.6	43.2	85.2	84	1.2	7
	6	Внут.	●	MAS0680LB	42.0	66.2	108.2	107	1.2	7
6.9	3	Нар.	★	MAE0690MB	22.0	43.3	85.3	84	1.3	7
	3	Внут.	□	MAS0690MB	22.0	43.3	85.3	84	1.3	7
	6	Внут.	★	MAS0690LB	42.7	66.3	108.3	107	1.3	7
7.0	3	Нар.	★	MAE0700MB	22.3	43.3	85.3	84	1.3	7
	3	Внут.	★	MAS0700MB	22.3	43.3	85.3	84	1.3	7
	6	Внут.	●	MAS0700LB	43.3	66.3	108.3	107	1.3	7

* : Стандартные размеры отверстий для резьбонакатных метчиков.

DC (мм)	Глубина сверления (L/D)	Охлаждение (Внут./Нар.)	НТИ10	Обозначение	Размеры (мм)					
					LU	LCF	OAL	LF	PL	DCON
7.1	3	Нар.	★	MAE0710MB	22.6	49.3	91.3	90	1.3	8
	3	Внут.	□	MAS0710MB	22.6	49.3	91.3	90	1.3	8
	6	Внут.	★	MAS0710LB	43.9	69.3	111.3	110	1.3	8
7.2	3	Нар.	★	MAE0720MB	22.9	49.3	91.3	90	1.3	8
	3	Внут.	□	MAS0720MB	22.9	49.3	91.3	90	1.3	8
	6	Внут.	★	MAS0720LB	44.5	69.3	111.3	110	1.3	8
7.3	3	Нар.	★	MAE0730MB	23.2	49.3	91.3	90	1.3	8
	3	Внут.	□	MAS0730MB	23.2	49.3	91.3	90	1.3	8
	6	Внут.	★	MAS0730LB	45.1	69.3	111.3	110	1.3	8
7.35	3	Нар.	★	* MAE0735MB	23.4	49.3	91.3	90	1.3	8
	3	Внут.	★	* MAS0735MB	23.4	49.3	91.3	90	1.3	8
	6	Внут.	●	* MAS0735LB	45.4	69.3	111.3	110	1.3	8
7.4	3	Нар.	★	MAE0740MB	23.5	49.3	91.3	90	1.3	8
	3	Внут.	□	MAS0740MB	23.5	49.3	91.3	90	1.3	8
	6	Внут.	★	MAS0740LB	45.7	69.3	111.3	110	1.3	8
7.5	3	Нар.	★	MAE0750MB	23.9	49.4	91.4	90	1.4	8
	3	Внут.	□	MAS0750MB	23.9	49.4	91.4	90	1.4	8
	6	Внут.	★	MAS0750LB	46.4	69.4	111.4	110	1.4	8
7.6	3	Нар.	★	MAE0760MB	24.2	49.4	91.4	90	1.4	8
	3	Внут.	□	MAS0760MB	24.2	49.4	91.4	90	1.4	8
	6	Внут.	★	MAS0760LB	47.0	73.4	115.4	114	1.4	8
7.7	3	Нар.	★	MAE0770MB	24.5	49.4	91.4	90	1.4	8
	3	Внут.	□	MAS0770MB	24.5	49.4	91.4	90	1.4	8
	6	Внут.	★	MAS0770LB	47.6	73.4	115.4	114	1.4	8
7.8	3	Нар.	★	MAE0780MB	24.8	49.4	91.4	90	1.4	8
	3	Внут.	□	MAS0780MB	24.8	49.4	91.4	90	1.4	8
	6	Внут.	★	MAS0780LB	48.2	73.4	115.4	114	1.4	8
7.9	3	Нар.	★	MAE0790MB	25.1	49.4	91.4	90	1.4	8
	3	Внут.	□	MAS0790MB	25.1	49.4	91.4	90	1.4	8
	6	Внут.	★	MAS0790LB	48.8	73.4	115.4	114	1.4	8
8.0	3	Нар.	★	MAE0800MB	25.5	49.5	91.5	90	1.5	8
	3	Внут.	●	MAS0800MB	25.5	49.5	91.5	90	1.5	8
	6	Внут.	●	MAS0800LB	49.5	73.5	115.5	114	1.5	8
8.1	3	Нар.	★	MAE0810MB	25.8	51.5	95.5	94	1.5	9
	3	Внут.	□	MAS0810MB	25.8	51.5	95.5	94	1.5	9
	6	Внут.	★	MAS0810LB	50.1	76.5	120.5	119	1.5	9
8.2	3	Нар.	★	MAE0820MB	26.1	51.5	95.5	94	1.5	9
	3	Внут.	□	MAS0820MB	26.1	51.5	95.5	94	1.5	9
	6	Внут.	★	MAS0820LB	50.7	76.5	120.5	119	1.5	9
8.3	3	Нар.	★	MAE0830MB	26.4	51.5	95.5	94	1.5	9
	3	Внут.	□	MAS0830MB	26.4	51.5	95.5	94	1.5	9
	6	Внут.	★	MAS0830LB	51.3	76.5	120.5	119	1.5	9
8.4	3	Нар.	★	MAE0840MB	26.7	51.5	95.5	94	1.5	9
	3	Внут.	□	MAS0840MB	26.7	51.5	95.5	94	1.5	9
	6	Внут.	★	MAS0840LB	51.9	76.5	120.5	119	1.5	9
8.5	3	Нар.	★	MAE0850MB	27.0	51.5	95.5	94	1.5	9
	3	Внут.	●	MAS0850MB	27.0	51.5	95.5	94	1.5	9
	6	Внут.	★	MAS0850LB	52.5	76.5	120.5	119	1.5	9

MAE, MAS

ТВЕРДЫЙ СПЛАВ

ИНСТРУМЕНТ ДЛЯ СВЕРЛЕНИЯ

M

DC (мм)	Глубина сверления (L/D)	Охлаждение (Внут./Нар.)	HT110	Обозначение	Размеры (мм)					
					LU	LCF	OAL	LF	PL	DCON
8.6	3	Нар.	★	MAE0860MB	27.4	51.6	95.6	94	1.6	9
	3	Внут.	□	MAS0860MB	27.4	51.6	95.6	94	1.6	9
	6	Внут.	★	MAS0860LB	53.2	78.6	122.6	121	1.6	9
8.7	3	Нар.	★	MAE0870MB	27.7	51.6	95.6	94	1.6	9
	3	Внут.	□	MAS0870MB	27.7	51.6	95.6	94	1.6	9
	6	Внут.	★	MAS0870LB	53.8	78.6	122.6	121	1.6	9
8.8	3	Нар.	★	MAE0880MB	28.0	51.6	95.6	94	1.6	9
	3	Внут.	□	MAS0880MB	28.0	51.6	95.6	94	1.6	9
	6	Внут.	★	MAS0880LB	54.4	78.6	122.6	121	1.6	9
8.9	3	Нар.	★	MAE0890MB	28.3	51.6	95.6	94	1.6	9
	3	Внут.	□	MAS0890MB	28.3	51.6	95.6	94	1.6	9
	6	Внут.	★	MAS0890LB	55.0	78.6	122.6	121	1.6	9
9.0	3	Нар.	★	MAE0900MB	28.6	51.6	95.6	94	1.6	9
	3	Внут.	★	MAS0900MB	28.6	51.6	95.6	94	1.6	9
	6	Внут.	●	MAS0900LB	55.6	78.6	122.6	121	1.6	9
9.1	3	Нар.	★	MAE0910MB	29.0	54.7	98.7	97	1.7	10
	3	Внут.	□	MAS0910MB	29.0	54.7	98.7	97	1.7	10
	6	Внут.	★	MAS0910LB	56.3	82.7	126.7	125	1.7	10
9.2	3	Нар.	★	MAE0920MB	29.3	54.7	98.7	97	1.7	10
	3	Внут.	□	MAS0920MB	29.3	54.7	98.7	97	1.7	10
	6	Внут.	★	MAS0920LB	56.9	82.7	126.7	125	1.7	10
9.21	3	Нар.	★	* MAE0921MB	29.3	54.7	98.7	97	1.7	10
	3	Внут.	★	* MAS0921MB	29.3	54.7	98.7	97	1.7	10
	6	Внут.	★	* MAS0921LB	57.0	82.7	126.7	125	1.7	10
9.3	3	Нар.	★	MAE0930MB	29.6	54.7	98.7	97	1.7	10
	3	Внут.	□	MAS0930MB	29.6	54.7	98.7	97	1.7	10
	6	Внут.	★	MAS0930LB	57.5	82.7	126.7	125	1.7	10
9.4	3	Нар.	★	MAE0940MB	29.9	54.7	98.7	97	1.7	10
	3	Внут.	□	MAS0940MB	29.9	54.7	98.7	97	1.7	10
	6	Внут.	★	MAS0940LB	58.1	82.7	126.7	125	1.7	10
9.5	3	Нар.	★	MAE0950MB	30.2	54.7	98.7	97	1.7	10
	3	Внут.	★	MAS0950MB	30.2	54.7	98.7	97	1.7	10
	6	Внут.	●	MAS0950LB	58.7	82.7	126.7	125	1.7	10
9.6	3	Нар.	★	MAE0960MB	30.5	54.7	98.7	97	1.7	10
	3	Внут.	□	MAS0960MB	30.5	54.7	98.7	97	1.7	10
	6	Внут.	★	MAS0960LB	59.3	82.7	126.7	125	1.7	10
9.7	3	Нар.	★	MAE0970MB	30.9	54.8	98.8	97	1.8	10
	3	Внут.	□	MAS0970MB	30.9	54.8	98.8	97	1.8	10
	6	Внут.	★	MAS0970LB	60.0	82.8	126.8	125	1.8	10
9.8	3	Нар.	★	MAE0980MB	31.2	54.8	98.8	97	1.8	10
	3	Внут.	□	MAS0980MB	31.2	54.8	98.8	97	1.8	10
	6	Внут.	★	MAS0980LB	60.6	82.8	126.8	125	1.8	10
9.9	3	Нар.	★	MAE0990MB	31.5	54.8	98.8	97	1.8	10
	3	Внут.	□	MAS0990MB	31.5	54.8	98.8	97	1.8	10
	6	Внут.	★	MAS0990LB	61.2	82.8	126.8	125	1.8	10
10.0	3	Нар.	★	MAE1000MB	31.8	54.8	98.8	97	1.8	10
	3	Внут.	●	MAS1000MB	31.8	54.8	98.8	97	1.8	10
	6	Внут.	●	MAS1000LB	61.8	82.8	126.8	125	1.8	10

* : Стандартные размеры отверстий для резьбонакатных метчиков.

DC (мм)	Глубина сверления (L/D)	Охлаждение (Внут./Нар.)	HT110	Обозначение	Размеры (мм)					
					LU	LCF	OAL	LF	PL	DCON
10.1	3	Нар.	□	MAE1010MB	32.1	56.8	102.8	101	1.8	11
	3	Внут.	□	MAS1010MB	32.1	56.8	102.8	101	1.8	11
	6	Внут.	□	MAS1010LB	62.4	90.8	136.8	135	1.8	11
10.2	3	Нар.	□	MAE1020MB	32.5	56.9	102.9	101	1.9	11
	3	Внут.	□	MAS1020MB	32.5	56.9	102.9	101	1.9	11
	6	Внут.	□	MAS1020LB	63.1	90.9	136.9	135	1.9	11
10.3	3	Нар.	★	MAE1030MB	32.8	56.9	102.9	101	1.9	11
	3	Внут.	★	MAS1030MB	32.8	56.9	102.9	101	1.9	11
	6	Внут.	●	MAS1030LB	63.7	90.9	136.9	135	1.9	11
10.4	3	Нар.	□	MAE1040MB	33.1	56.9	102.9	101	1.9	11
	3	Внут.	□	MAS1040MB	33.1	56.9	102.9	101	1.9	11
	6	Внут.	□	MAS1040LB	64.3	90.9	136.9	135	1.9	11
10.5	3	Нар.	★	MAE1050MB	33.4	56.9	102.9	101	1.9	11
	3	Внут.	★	MAS1050MB	33.4	56.9	102.9	101	1.9	11
	6	Внут.	●	MAS1050LB	64.9	90.9	136.9	135	1.9	11
10.6	3	Нар.	□	MAE1060MB	33.7	56.9	102.9	101	1.9	11
	3	Внут.	□	MAS1060MB	33.7	56.9	102.9	101	1.9	11
	6	Внут.	□	MAS1060LB	65.5	90.9	136.9	135	1.9	11
10.7	3	Нар.	□	MAE1070MB	34.0	56.9	102.9	101	1.9	11
	3	Внут.	□	MAS1070MB	34.0	56.9	102.9	101	1.9	11
	6	Внут.	□	MAS1070LB	66.1	90.9	136.9	135	1.9	11
10.8	3	Нар.	□	MAE1080MB	34.4	57.0	103.0	101	2.0	11
	3	Внут.	□	MAS1080MB	34.4	57.0	103.0	101	2.0	11
	6	Внут.	□	MAS1080LB	66.8	91.0	137.0	135	2.0	11
10.9	3	Нар.	□	MAE1090MB	34.7	57.0	103.0	101	2.0	11
	3	Внут.	□	MAS1090MB	34.7	57.0	103.0	101	2.0	11
	6	Внут.	□	MAS1090LB	67.4	91.0	137.0	135	2.0	11
11.0	3	Нар.	★	MAE1100MB	35.0	57.0	103.0	101	2.0	11
	3	Внут.	★	MAS1100MB	35.0	57.0	103.0	101	2.0	11
	6	Внут.	●	MAS1100LB	68.0	91.0	137.0	135	2.0	11
11.08	3	Нар.	★	* MAE1108MB	35.2	62.0	108.0	106	2.0	12
	3	Внут.	★	* MAS1108MB	35.2	62.0	108.0	106	2.0	12
	6	Внут.	●	* MAS1108LB	68.5	96.0	142.0	140	2.0	12
11.1	3	Нар.	□	MAE1110MB	35.3	62.0	108.0	106	2.0	12
	3	Внут.	□	MAS1110MB	35.3	62.0	108.0	106	2.0	12
	6	Внут.	□	MAS1110LB	68.6	96.0	142.0	140	2.0	12
11.2	3	Нар.	□	MAE1120MB	35.6	62.0	108.0	106	2.0	12
	3	Внут.	□	MAS1120MB	35.6	62.0	108.0	106	2.0	12
	6	Внут.	□	MAS1120LB	69.2	96.0	142.0	140	2.0	12
11.3	3	Нар.	□	MAE1130MB	36.0	62.1	108.1	106	2.1	12
	3	Внут.	□	MAS1130MB	36.0	62.1	108.1	106	2.1	12
	6	Внут.	□	MAS1130LB	69.9	96.1	142.1	140	2.1	12
11.4	3	Нар.	□	MAE1140MB	36.3	62.1	108.1	106	2.1	12
	3	Внут.	□	MAS1140MB	36.3	62.1	108.1	106	2.1	12
	6	Внут.	□	MAS1140LB	70.5	96.1	142.1	140	2.1	12
11.5	3	Нар.	□	MAE1150MB	36.6	62.1	108.1	106	2.1	12
	3	Внут.	□	MAS1150MB	36.6	62.1	108.1	106	2.1	12
	6	Внут.	□	MAS1150LB	71.1	96.1	142.1	140	2.1	12

● : Есть на складе. ★ : Со склада в Японии.

□ : Нет на складе, выпускается исключительно под заказ.

DC (мм)	Глубина сверления (L/D)	Охлаждение (Внут./Нар.)	НТ110	Обозначение	Размеры (мм)					
					LU	LCF	OAL	LF	PL	DCON
11.6	3 Нар.	□	□	MAE1160MB	36.9	62.1	108.1	106	2.1	12
	3 Внут.	□	□	MAS1160MB	36.9	62.1	108.1	106	2.1	12
	6 Внут.	□	□	MAS1160LB	71.7	96.1	142.1	140	2.1	12
11.7	3 Нар.	□	□	MAE1170MB	37.2	62.1	108.1	106	2.1	12
	3 Внут.	□	□	MAS1170MB	37.2	62.1	108.1	106	2.1	12
	6 Внут.	□	□	MAS1170LB	72.3	96.1	142.1	140	2.1	12
11.8	3 Нар.	□	□	MAE1180MB	37.5	62.1	108.1	106	2.1	12
	3 Внут.	□	□	MAS1180MB	37.5	62.1	108.1	106	2.1	12
	6 Внут.	□	□	MAS1180LB	72.9	96.1	142.1	140	2.1	12
11.9	3 Нар.	□	□	MAE1190MB	37.9	62.2	108.2	106	2.2	12
	3 Внут.	□	□	MAS1190MB	37.9	62.2	108.2	106	2.2	12
	6 Внут.	□	□	MAS1190LB	73.6	96.2	142.2	140	2.2	12
12.0	3 Нар.	★	★	MAE1200MB	38.2	62.2	108.2	106	2.2	12
	3 Внут.	●	●	MAS1200MB	38.2	62.2	108.2	106	2.2	12
	6 Внут.	●	●	MAS1200LB	74.2	96.2	142.2	140	2.2	12
12.1	3 Нар.	□	□	MAE1210MB	38.5	67.2	117.2	115	2.2	13
	3 Внут.	□	□	MAS1210MB	38.5	67.2	117.2	115	2.2	13
	6 Внут.	□	□	MAS1210LB	74.8	102.2	152.2	150	2.2	13
12.2	3 Нар.	□	□	MAE1220MB	38.8	67.2	117.2	115	2.2	13
	3 Внут.	□	□	MAS1220MB	38.8	67.2	117.2	115	2.2	13
	6 Внут.	□	□	MAS1220LB	75.4	102.2	152.2	150	2.2	13
12.3	3 Нар.	□	□	MAE1230MB	39.1	67.2	117.2	115	2.2	13
	3 Внут.	□	□	MAS1230MB	39.1	67.2	117.2	115	2.2	13
	6 Внут.	□	□	MAS1230LB	76.0	102.2	152.2	150	2.2	13
12.4	3 Нар.	□	□	MAE1240MB	39.5	67.3	117.3	115	2.3	13
	3 Внут.	□	□	MAS1240MB	39.5	67.3	117.3	115	2.3	13
	6 Внут.	□	□	MAS1240LB	76.7	102.3	152.3	150	2.3	13
12.5	3 Нар.	★	★	MAE1250MB	39.8	67.3	117.3	115	2.3	13
	3 Внут.	●	●	MAS1250MB	39.8	67.3	117.3	115	2.3	13
	6 Внут.	●	●	MAS1250LB	77.3	102.3	152.3	150	2.3	13
12.6	3 Нар.	□	□	MAE1260MB	40.1	67.3	117.3	115	2.3	13
	3 Внут.	□	□	MAS1260MB	40.1	67.3	117.3	115	2.3	13
	6 Внут.	□	□	MAS1260LB	77.9	102.3	152.3	150	2.3	13
12.7	3 Нар.	□	□	MAE1270MB	40.4	67.3	117.3	115	2.3	13
	3 Внут.	□	□	MAS1270MB	40.4	67.3	117.3	115	2.3	13
	6 Внут.	□	□	MAS1270LB	78.5	102.3	152.3	150	2.3	13
12.8	3 Нар.	□	□	MAE1280MB	40.7	67.3	117.3	115	2.3	13
	3 Внут.	□	□	MAS1280MB	40.7	67.3	117.3	115	2.3	13
	6 Внут.	□	□	MAS1280LB	79.1	102.3	152.3	150	2.3	13
12.9	3 Нар.	□	□	MAE1290MB	41.0	67.3	117.3	115	2.3	13
	3 Внут.	□	□	MAS1290MB	41.0	67.3	117.3	115	2.3	13
	6 Внут.	□	□	MAS1290LB	79.7	102.3	152.3	150	2.3	13
12.96	3 Нар.	★	★	*MAE1296MB	41.3	67.4	117.4	115	2.4	13
	3 Внут.	★	★	*MAS1296MB	41.3	67.4	117.4	115	2.4	13
	6 Внут.	★	★	*MAS1296LB	80.2	102.4	152.4	150	2.4	13
13.0	3 Нар.	★	★	MAE1300MB	41.4	67.4	117.4	115	2.4	13
	3 Внут.	★	★	MAS1300MB	41.4	67.4	117.4	115	2.4	13
	6 Внут.	●	●	MAS1300LB	80.4	102.4	152.4	150	2.4	13

* : Стандартные размеры отверстий для резьбонакатных метчиков.

DC (мм)	Глубина сверления (L/D)	Охлаждение (Внут./Нар.)	НТ110	Обозначение	Размеры (мм)					
					LU	LCF	OAL	LF	PL	DCON
13.1	3 Нар.	□	□	MAE1310MB	41.7	72.4	122.4	120	2.4	14
	3 Внут.	□	□	MAS1310MB	41.7	72.4	122.4	120	2.4	14
	6 Внут.	□	□	MAS1310LB	81.0	112.4	162.4	160	2.4	14
13.2	3 Нар.	□	□	MAE1320MB	42.0	72.4	122.4	120	2.4	14
	3 Внут.	□	□	MAS1320MB	42.0	72.4	122.4	120	2.4	14
	6 Внут.	□	□	MAS1320LB	81.6	112.4	162.4	160	2.4	14
13.3	3 Нар.	□	□	MAE1330MB	42.3	72.4	122.4	120	2.4	14
	3 Внут.	□	□	MAS1330MB	42.3	72.4	122.4	120	2.4	14
	6 Внут.	□	□	MAS1330LB	82.2	112.4	162.4	160	2.4	14
13.4	3 Нар.	□	□	MAE1340MB	42.6	72.4	122.4	120	2.4	14
	3 Внут.	□	□	MAS1340MB	42.6	72.4	122.4	120	2.4	14
	6 Внут.	□	□	MAS1340LB	82.8	112.4	162.4	160	2.4	14
13.5	3 Нар.	★	★	MAE1350MB	43.0	72.5	122.5	120	2.5	14
	3 Внут.	★	★	MAS1350MB	43.0	72.5	122.5	120	2.5	14
	6 Внут.	★	★	MAS1350LB	83.5	112.5	162.5	160	2.5	14
13.6	3 Нар.	□	□	MAE1360MB	43.3	72.5	122.5	120	2.5	14
	3 Внут.	□	□	MAS1360MB	43.3	72.5	122.5	120	2.5	14
	6 Внут.	□	□	MAS1360LB	84.1	112.5	162.5	160	2.5	14
13.7	3 Нар.	□	□	MAE1370MB	43.6	72.5	122.5	120	2.5	14
	3 Внут.	□	□	MAS1370MB	43.6	72.5	122.5	120	2.5	14
	6 Внут.	□	□	MAS1370LB	84.7	112.5	162.5	160	2.5	14
13.8	3 Нар.	□	□	MAE1380MB	43.9	72.5	122.5	120	2.5	14
	3 Внут.	□	□	MAS1380MB	43.9	72.5	122.5	120	2.5	14
	6 Внут.	□	□	MAS1380LB	85.3	112.5	162.5	160	2.5	14
13.9	3 Нар.	□	□	MAE1390MB	44.2	72.5	122.5	120	2.5	14
	3 Внут.	□	□	MAS1390MB	44.2	72.5	122.5	120	2.5	14
	6 Внут.	□	□	MAS1390LB	85.9	112.5	162.5	160	2.5	14
14.0	3 Нар.	★	★	MAE1400MB	44.5	72.5	122.5	120	2.5	14
	3 Внут.	●	●	MAS1400MB	44.5	72.5	122.5	120	2.5	14
	6 Внут.	●	●	MAS1400LB	86.5	112.5	162.5	160	2.5	14
14.1	3 Нар.	□	□	MAE1410MB	44.9	74.6	132.6	130	2.6	15
	3 Внут.	□	□	MAS1410MB	44.9	74.6	132.6	130	2.6	15
	6 Внут.	□	□	MAS1410LB	87.2	117.6	175.6	173	2.6	15
14.2	3 Нар.	□	□	MAE1420MB	45.2	74.6	132.6	130	2.6	15
	3 Внут.	□	□	MAS1420MB	45.2	74.6	132.6	130	2.6	15
	6 Внут.	□	□	MAS1420LB	87.8	117.6	175.6	173	2.6	15
14.3	3 Нар.	□	□	MAE1430MB	45.5	74.6	132.6	130	2.6	15
	3 Внут.	□	□	MAS1430MB	45.5	74.6	132.6	130	2.6	15
	6 Внут.	□	□	MAS1430LB	88.4	117.6	175.6	173	2.6	15
14.4	3 Нар.	□	□	MAE1440MB	45.8	74.6	132.6	130	2.6	15
	3 Внут.	□	□	MAS1440MB	45.8	74.6	132.6	130	2.6	15
	6 Внут.	□	□	MAS1440LB	89.0	117.6	175.6	173	2.6	15
14.5	3 Нар.	□	□	MAE1450MB	46.1	74.6	132.6	130	2.6	15
	3 Внут.	□	□	MAS1450MB	46.1	74.6	132.6	130	2.6	15
	6 Внут.	□	□	MAS1450LB	89.6	117.6	175.6	173	2.6	15
14.6	3 Нар.	□	□	MAE1460MB	46.5	74.7	132.7	130	2.7	15
	3 Внут.	□	□	MAS1460MB	46.5	74.7	132.7	130	2.7	15
	6 Внут.	□	□	MAS1460LB	90.3	117.7	175.7	173	2.7	15

MAE, MAS

DC (мм)	Глубина сверления (L/D)	Охлаждение (Внут./Нар.)	HT110	Обозначение	Размеры (мм)					
					LU	LCF	OAL	LF	PL	DCON
14.7	3	Нар.	<input type="checkbox"/>	MAE1470MB	46.8	74.7	132.7	130	2.7	15
	3	Внут.	<input type="checkbox"/>	MAS1470MB	46.8	74.7	132.7	130	2.7	15
	6	Внут.	<input type="checkbox"/>	MAS1470LB	90.9	117.7	175.7	173	2.7	15
14.8	3	Нар.	<input type="checkbox"/>	MAE1480MB	47.1	74.7	132.7	130	2.7	15
	3	Внут.	<input type="checkbox"/>	MAS1480MB	47.1	74.7	132.7	130	2.7	15
	6	Внут.	<input type="checkbox"/>	MAS1480LB	91.5	117.7	175.7	173	2.7	15
14.9	3	Нар.	<input type="checkbox"/>	MAE1490MB	47.4	74.7	132.7	130	2.7	15
	3	Внут.	<input type="checkbox"/>	MAS1490MB	47.4	74.7	132.7	130	2.7	15
	6	Внут.	<input type="checkbox"/>	MAS1490LB	92.1	117.7	175.7	173	2.7	15
14.96	3	Нар.	★	* MAE1496MB	47.6	74.7	132.7	130	2.7	15
	3	Внут.	★	* MAS1496MB	47.6	74.7	132.7	130	2.7	15
	6	Внут.	★	* MAS1496LB	92.5	117.7	175.7	173	2.7	15
15.0	3	Нар.	★	MAE1500MB	47.7	74.7	132.7	130	2.7	15
	3	Внут.	★	MAS1500MB	47.7	74.7	132.7	130	2.7	15
	6	Внут.	●	MAS1500LB	92.7	117.7	175.7	173	2.7	15
15.1	3	Нар.	<input type="checkbox"/>	MAE1510MB	48.0	78.7	136.7	134	2.7	16
	3	Внут.	<input type="checkbox"/>	MAS1510MB	48.0	78.7	136.7	134	2.7	16
	6	Внут.	<input type="checkbox"/>	MAS1510LB	93.3	122.7	180.7	178	2.7	16
15.2	3	Нар.	<input type="checkbox"/>	MAE1520MB	48.4	78.8	136.8	134	2.8	16
	3	Внут.	<input type="checkbox"/>	MAS1520MB	48.4	78.8	136.8	134	2.8	16
	6	Внут.	<input type="checkbox"/>	MAS1520LB	94.0	122.8	180.8	178	2.8	16
15.3	3	Нар.	<input type="checkbox"/>	MAE1530MB	48.7	78.8	136.8	134	2.8	16
	3	Внут.	<input type="checkbox"/>	MAS1530MB	48.7	78.8	136.8	134	2.8	16
	6	Внут.	<input type="checkbox"/>	MAS1530LB	94.6	122.8	180.8	178	2.8	16
15.4	3	Нар.	<input type="checkbox"/>	MAE1540MB	49.0	78.8	136.8	134	2.8	16
	3	Внут.	<input type="checkbox"/>	MAS1540MB	49.0	78.8	136.8	134	2.8	16
	6	Внут.	<input type="checkbox"/>	MAS1540LB	95.2	122.8	180.8	178	2.8	16
15.5	3	Нар.	<input type="checkbox"/>	MAE1550MB	49.3	78.8	136.8	134	2.8	16
	3	Внут.	<input type="checkbox"/>	MAS1550MB	49.3	78.8	136.8	134	2.8	16
	6	Внут.	<input type="checkbox"/>	MAS1550LB	95.8	122.8	180.8	178	2.8	16
15.6	3	Нар.	<input type="checkbox"/>	MAE1560MB	49.6	78.8	136.8	134	2.8	16
	3	Внут.	<input type="checkbox"/>	MAS1560MB	49.6	78.8	136.8	134	2.8	16
	6	Внут.	<input type="checkbox"/>	MAS1560LB	96.4	122.8	180.8	178	2.8	16
15.7	3	Нар.	<input type="checkbox"/>	MAE1570MB	50.0	78.9	136.9	134	2.9	16
	3	Внут.	<input type="checkbox"/>	MAS1570MB	50.0	78.9	136.9	134	2.9	16
	6	Внут.	<input type="checkbox"/>	MAS1570LB	97.1	122.9	180.9	178	2.9	16
15.8	3	Нар.	<input type="checkbox"/>	MAE1580MB	50.3	78.9	136.9	134	2.9	16
	3	Внут.	<input type="checkbox"/>	MAS1580MB	50.3	78.9	136.9	134	2.9	16
	6	Внут.	<input type="checkbox"/>	MAS1580LB	97.7	122.9	180.9	178	2.9	16
15.9	3	Нар.	<input type="checkbox"/>	MAE1590MB	50.6	78.9	136.9	134	2.9	16
	3	Внут.	<input type="checkbox"/>	MAS1590MB	50.6	78.9	136.9	134	2.9	16
	6	Внут.	<input type="checkbox"/>	MAS1590LB	98.3	122.9	180.9	178	2.9	16
16.0	3	Нар.	★	MAE1600MB	50.9	78.9	136.9	134	2.9	16
	3	Внут.	★	MAS1600MB	50.9	78.9	136.9	134	2.9	16
	6	Внут.	●	MAS1600LB	98.9	122.9	180.9	178	2.9	16

* : Стандартные размеры отверстий для резьбонакатных метчиков.

● : Есть на складе. ★ : Со склада в Японии.

□ : Нет на складе, выпускается исключительно под заказ.

РЕКОМЕНДУЕМЫЕ РЕЖИМЫ РЕЗАНИЯ

Тип	Обрабатываемый материал	Диам. сверла $\phi 3.0 - \phi 6.0$		Диам. сверла $\phi 6.1 - \phi 10.0$		Диам. сверла $\phi 10.1 - \phi 16.0$	
		Скорость резания (м/мин)	Подача (мм/об)	Скорость резания (м/мин)	Подача (мм/об)	Скорость резания (м/мин)	Подача (мм/об)
MAE	N Алюминиевые сплавы	90 (40–140)	0.15 (0.05–0.3)	100 (50–150)	0.2 (0.1–0.3)	120 (60–170)	0.25 (0.1–0.4)
		100 (60–150)	0.12 (0.05–0.25)	110 (70–160)	0.15 (0.05–0.25)	130 (80–180)	0.2 (0.1–0.3)
	K Серый чугун	40 (20–60)	0.15 (0.1–0.2)	60 (40–80)	0.2 (0.1–0.3)	80 (60–100)	0.3 (0.2–0.4)
		Ковкий чугун	30 (20–40)	0.1 (0.05–0.15)	40 (20–60)	0.12 (0.05–0.2)	60 (40–80)
MAS	N Алюминиевые сплавы	100 (60–150)	0.15 (0.05–0.3)	120 (80–170)	0.2 (0.1–0.3)	150 (100–200)	0.25 (0.1–0.4)
		120 (80–170)	0.12 (0.05–0.25)	150 (100–180)	0.15 (0.05–0.25)	160 (120–200)	0.2 (0.1–0.3)
	K Серый чугун	60 (40–80)	0.15 (0.1–0.2)	80 (60–110)	0.2 (0.1–0.3)	100 (70–130)	0.3 (0.2–0.4)
		Ковкий чугун	45 (30–60)	0.1 (0.05–0.15)	60 (40–80)	0.12 (0.05–0.2)	80 (60–100)

M

ИНСТРУМЕНТ ДЛЯ
СВЕРЛЕНИЯ

■ ДИАМЕТРЫ ОТВЕРСТИЙ И СВЕРЛ ДЛЯ НАРЕЗАНИЯ РЕЗЬБЫ

Диаметр и шаг резьбы	Нарезание резьбы			Накатка резьбы		
	Диаметр сверла (DC)	Диаметр отверстия		Диаметр сверла (DC)	Диаметр отверстия	
		мин.	макс.		мин.	макс.
M4x0.7	3.3	3.242	3.422	3.65	3.65	3.70
M5x0.8	4.2	4.134	4.334	4.60	4.59	4.66
M6x1.0	5.0	4.917	5.153	5.50	5.48	5.57
M8x1.25	6.8	6.647	6.912	7.35	7.34	7.41
M10x1.5	8.5	8.376	8.676	9.21	9.18	9.28
M12x1.75	10.3	10.106	10.441	11.08	11.05	11.15
M14x2	12.0	11.835	12.210	12.96	12.92	13.04
M16x2	14.0	13.835	14.210	14.96	14.92	15.04

ИНСТРУМЕНТ ДЛЯ СВЕРЛЕНИЯ (МОНОЛИТНЫЕ ТВЕРДОСПЛАВНЫЕ СВЕРЛА)

ТВЕРДЫЙ СПЛАВ

MHS

- Высокое сопротивление продольному изгибу и уникальная двойная ленточка.
- Сверление без периодического вывода сверла и длительный срок службы инструмента для сверления стали с высокой твердостью, 35HRC-55HRC.



P M K N S H

Внутреннее охлаждение

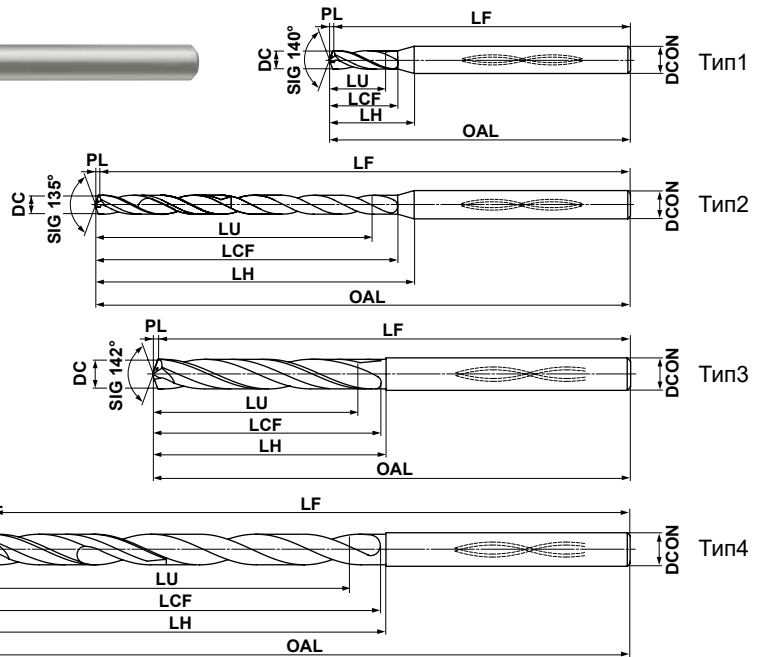

	DC ≤ 3	3 < DC ≤ 6	6 < DC ≤ 10	10 < DC ≤ 12
	+0.010	+0.010	+0.010	+0.010
	-0.002	-0.002	-0.005	-0.008
	DCON=3	3 < DCON ≤ 6	6 < DCON ≤ 10	10 < DCON ≤ 12
h6	0	0	0	0
	-0.006	-0.008	-0.009	-0.011

- Сверла MHS предназначены для использования с термоматронами.
- Используйте самое короткое сверло такого же диаметра для сверления направляющего отверстия.

DC (мм)	Глубина сверления (L/D)	VP15TF	Обозначение	Размеры (мм)							Тип
				LU	LCF	LH	OAL	LF	PL	DCON	
0.95	3	★	MHS0095L006B	3.0	6.2	10.0	60.2	60	0.17	3	1
	6	★	MHS0095L009B	5.9	9.2	13.0	60.2	60	0.17	3	2
	13	★	MHS0095L015B	12.5	15.2	19.0	60.2	60	0.17	3	2
	23	★	MHS0095L025B	22.0	25.2	29.0	60.2	60	0.17	3	2
	30	★	MHS0095L035B	28.7	35.2	39.0	80.2	80	0.17	3	2
1.00	3	●	MHS0100L006B	3.2	6.2	9.9	60.2	60	0.2	3	1
	6	●	MHS0100L009B	6.2	9.2	12.9	60.2	60	0.2	3	2
	12	★	MHS0100L015B	12.2	15.2	18.9	60.2	60	0.2	3	2
	22	●	MHS0100L025B	22.2	25.2	28.9	60.2	60	0.2	3	2
	30	●	MHS0100L035B	30.2	35.2	38.9	80.2	80	0.2	3	2
1.10	2	●	MHS0110L006B	2.4	6.2	9.7	60.2	60	0.2	3	1
	5	★	MHS0110L009B	5.7	9.2	12.7	60.2	60	0.2	3	2
	11	●	MHS0110L015B	12.3	15.2	18.7	60.2	60	0.2	3	2
	20	●	MHS0110L025B	22.2	25.2	28.7	60.2	60	0.2	3	2
	29	●	MHS0110L035B	32.1	35.2	38.7	80.2	80	0.2	3	2
1.20	2	●	MHS0120L006B	2.6	6.2	9.6	60.2	60	0.2	3	1
	5	★	MHS0120L009B	6.2	9.2	12.6	60.2	60	0.2	3	2
	10	●	MHS0120L015B	12.2	15.2	18.6	60.2	60	0.2	3	2
	18	●	MHS0120L025B	21.8	25.2	28.6	60.2	60	0.2	3	2
	26	●	MHS0120L035B	31.4	35.2	38.6	80.2	80	0.2	3	2
1.30	2	●	MHS0130L007B	2.8	7.2	10.4	60.2	60	0.2	3	1
	5	★	MHS0130L011B	6.8	11.3	14.5	60.3	60	0.3	3	2
	12	●	MHS0130L020B	15.9	20.3	23.5	60.3	60	0.3	3	2
	20	●	MHS0130L030B	26.3	30.3	33.5	80.3	80	0.3	3	2
	30	●	MHS0130L045B	39.3	45.3	48.5	80.3	80	0.3	3	2

DC (мм)	Глубина сверления (L/D)	VP15TF	Обозначение	Размеры (мм)							Тип
				LU	LCF	LH	OAL	LF	PL	DCON	
1.40	2	●	MHS0140L007B	3.1	7.3	10.3	60.3	60	0.3	3	1
	5	★	MHS0140L011B	7.3	11.3	14.3	60.3	60	0.3	3	2
	11	●	MHS0140L020B	15.7	20.3	23.3	60.3	60	0.3	3	2
	18	★	MHS0140L030B	25.5	30.3	33.3	80.3	80	0.3	3	2
	29	★	MHS0140L045B	40.9	45.3	48.3	80.3	80	0.3	3	2
1.45	3	●	MHS0145L008B	4.7	8.3	11.2	60.3	60	0.3	3	1
	6	★	MHS0145L013B	9.0	13.3	16.2	60.3	60	0.3	3	2
	11	★	MHS0145L020B	16.3	20.3	23.2	60.3	60	0.3	3	2
	21	●	MHS0145L035B	30.8	35.3	38.2	80.3	80	0.3	3	2
	30	★	MHS0145L055B	43.8	55.3	58.2	100.3	100	0.3	3	2
1.50	2	●	MHS0150L008B	3.3	8.3	11.1	60.3	60	0.3	3	1
	6	★	MHS0150L013B	9.3	13.3	16.1	60.3	60	0.3	3	2
	10	●	MHS0150L020B	15.3	20.3	23.1	60.3	60	0.3	3	2
	20	●	MHS0150L035B	30.3	35.3	38.1	80.3	80	0.3	3	2
	30	●	MHS0150L055B	45.3	55.3	58.1	100.3	100	0.3	3	2
1.60	2	●	MHS0160L008B	3.5	8.3	10.9	60.3	60	0.3	3	1
	5	★	MHS0160L013B	8.3	13.3	15.9	60.3	60	0.3	3	2
	10	●	MHS0160L020B	16.3	20.3	22.9	60.3	60	0.3	3	2
	19	●	MHS0160L035B	30.7	35.3	37.9	80.3	80	0.3	3	2
	30	●	MHS0160L055B	48.3	55.3	57.9	100.3	100	0.3	3	2
1.70	2	●	MHS0170L008B	3.7	8.3	10.7	60.3	60	0.3	3	1
	5	★	MHS0170L013B	8.9	13.4	15.8	60.4	60	0.4	3	2
	9	●	MHS0170L020B	15.7	20.4	22.8	60.4	60	0.4	3	2
	18	●	MHS0170L035B	31.0	35.4	37.8	80.4	80	0.4	3	2
	29	●	MHS0170L055B	49.7	55.4	57.8	100.4	100	0.4	3	2

Примечание 1) Пожалуйста, свяжитесь с нами если Вы не нашли нужную геометрию в данном каталоге (могут быть заказаны другие диаметры и длины).

● : Есть на складе. ★ : Со склада в Японии.

□ : Нет на складе, выпускается исключительно под заказ.

DC	Глубина сверления (L/D)	VP15TF	Обозначение	Размеры (мм)								Тип
				LU	LCF	LH	OAL	LF	PL	DCON		
1.80	3	●	MHS0180L010B	5.7	10.3	12.5	60.3	60	0.3	3	1	
	5	★	MHS0180L015B	9.4	15.4	17.6	60.4	60	0.4	3	2	
	11	●	MHS0180L025B	20.2	25.4	27.6	60.4	60	0.4	3	2	
	22	●	MHS0180L045B	40.0	45.4	47.6	80.4	80	0.4	3	2	
	30	●	MHS0180L065B	54.4	65.4	67.6	100.4	100	0.4	3	2	
1.90	2	●	MHS0190L010B	4.1	10.3	12.4	60.3	60	0.3	3	1	
	5	★	MHS0190L015B	9.9	15.4	17.5	60.4	60	0.4	3	2	
	10	●	MHS0190L025B	19.4	25.4	27.5	60.4	60	0.4	3	2	
	21	●	MHS0190L045B	40.3	45.4	47.5	80.4	80	0.4	3	2	
	30	●	MHS0190L065B	57.4	65.4	67.5	100.4	100	0.4	3	2	
1.95	2	●	MHS0195L010B	4.3	10.4	12.4	60.4	60	0.4	3	1	
	5	★	MHS0195L015B	10.2	15.4	17.4	60.4	60	0.4	3	2	
	10	★	MHS0195L025B	19.9	25.4	27.4	60.4	60	0.4	3	2	
	20	●	MHS0195L045B	39.4	45.4	47.4	80.4	80	0.4	3	2	
	30	★	MHS0195L065B	58.9	65.4	67.4	100.4	100	0.4	3	2	
2.00	2	●	MHS0200L010B	4.4	10.4	12.3	60.4	60	0.4	3	1	
	5	★	MHS0200L015B	10.4	15.4	17.3	60.4	60	0.4	3	2	
	9	●	MHS0200L025B	18.4	25.4	27.3	60.4	60	0.4	3	2	
	20	●	MHS0200L045B	40.4	45.4	47.3	80.4	80	0.4	3	2	
	30	●	MHS0200L065B	60.4	65.4	67.3	100.4	100	0.4	3	2	
2.10	3	●	MHS0210L012B	6.7	12.4	14.1	60.4	60	0.4	3	1	
	7	★	MHS0210L020B	15.1	20.4	22.1	60.4	60	0.4	3	2	
	11	●	MHS0210L030B	23.5	30.4	32.1	80.4	80	0.4	3	2	
	23	●	MHS0210L055B	48.7	55.4	57.1	100.4	100	0.4	3	2	
	30	●	MHS0210L075B	63.4	75.4	77.1	120.4	120	0.4	3	2	
2.20	2	●	MHS0220L012B	4.8	12.4	13.9	60.4	60	0.4	3	1	
	6	★	MHS0220L020B	13.7	20.5	22.0	60.5	60	0.5	3	2	
	11	●	MHS0220L030B	24.7	30.5	32.0	80.5	80	0.5	3	2	
	22	●	MHS0220L055B	48.9	55.5	57.0	100.5	100	0.5	3	2	
	30	●	MHS0220L075B	66.5	75.5	77.0	120.5	120	0.5	3	2	
2.30	2	●	MHS0230L012B	5.0	12.4	13.7	60.4	60	0.4	3	1	
	6	★	MHS0230L020B	14.3	20.5	21.8	60.5	60	0.5	3	2	
	10	●	MHS0230L030B	23.5	30.5	31.8	80.5	80	0.5	3	2	
	21	●	MHS0230L055B	48.8	55.5	56.8	100.5	100	0.5	3	2	
	30	●	MHS0230L075B	69.5	75.5	76.8	120.5	120	0.5	3	2	
2.40	2	●	MHS0240L012B	5.2	12.4	13.5	60.4	60	0.4	3	1	
	5	★	MHS0240L020B	12.5	20.5	21.6	60.5	60	0.5	3	2	
	9	●	MHS0240L030B	22.1	30.5	31.6	80.5	80	0.5	3	2	
	20	●	MHS0240L055B	48.5	55.5	56.6	100.5	100	0.5	3	2	
	28	●	MHS0240L075B	67.7	75.5	76.6	120.5	120	0.5	3	2	
2.45	2	★	MHS0245L013B	5.3	13.4	14.4	70.4	70	0.4	4	1	
	5	★	MHS0245L020B	12.8	20.5	21.5	70.5	70	0.5	4	2	
	11	★	MHS0245L035B	27.5	35.5	36.5	90.5	90	0.5	4	2	
	24	★	MHS0245L065B	59.3	65.5	66.5	110.5	110	0.5	4	2	
	30	★	MHS0245L090B	74.0	90.5	91.5	140.5	140	0.5	4	2	
2.50	2	●	MHS0250L013B	5.5	13.5	16.3	70.5	70	0.5	4	1	
	5	★	MHS0250L020B	13.0	20.5	23.3	70.5	70	0.5	4	2	
	11	●	MHS0250L035B	28.0	35.5	38.3	90.5	90	0.5	4	2	
	23	●	MHS0250L065B	58.0	65.5	68.3	110.5	110	0.5	4	2	
	30	●	MHS0250L090B	75.5	90.5	93.3	140.5	140	0.5	4	2	

DC	Глубина сверления (L/D)	VP15TF	Обозначение	Размеры (мм)								Тип
				LU	LCF	LH	OAL	LF	PL	DCON		
2.60	2	●	MHS0260L013B	5.7	13.5	16.1	70.5	70	0.5	4	1	
	5	★	MHS0260L020B	13.5	20.5	23.1	70.5	70	0.5	4	2	
	10	●	MHS0260L035B	26.5	35.5	38.1	90.5	90	0.5	4	2	
	22	●	MHS0260L065B	57.7	65.5	68.1	110.5	110	0.5	4	2	
	30	●	MHS0260L090B	78.5	90.5	93.1	140.5	140	0.5	4	2	
2.70	2	●	MHS0270L013B	5.9	13.5	15.9	70.5	70	0.5	4	1	
	4	★	MHS0270L020B	11.4	20.6	23.0	70.6	70	0.6	4	2	
	10	●	MHS0270L035B	27.6	35.6	38.0	90.6	90	0.6	4	2	
	21	●	MHS0270L065B	57.3	65.6	68.0	110.6	110	0.6	4	2	
	30	●	MHS0270L090B	81.6	90.6	93.0	140.6	140	0.6	4	2	
2.80	2	●	MHS0280L014B	6.1	14.5	16.7	70.5	70	0.5	4	1	
	4	★	MHS0280L020B	11.8	20.6	22.8	70.6	70	0.6	4	2	
	9	●	MHS0280L035B	25.8	35.6	37.8	90.6	90	0.6	4	2	
	20	●	MHS0280L065B	56.6	65.6	67.8	110.6	110	0.6	4	2	
	29	●	MHS0280L090B	81.8	90.6	92.8	140.6	140	0.6	4	2	
2.90	2	●	MHS0290L014B	6.3	14.5	16.6	70.5	70	0.5	4	1	
	4	★	MHS0290L020B	12.2	20.6	22.7	70.6	70	0.6	4	2	
	9	●	MHS0290L035B	26.7	35.6	37.7	90.6	90	0.6	4	2	
	19	●	MHS0290L065B	55.7	65.6	67.7	110.6	110	0.6	4	2	
	28	●	MHS0290L090B	81.8	90.6	92.7	140.6	140	0.6	4	2	
2.95	2	★	MHS0295L014B	6.4	14.5	16.5	70.5	70	0.5	4	1	
	4	★	MHS0295L020B	12.4	20.6	22.6	70.6	70	0.6	4	2	
	9	★	MHS0295L035B	27.2	35.6	37.6	90.6	90	0.6	4	2	
	19	●	MHS0295L065B	56.7	65.6	67.6	110.6	110	0.6	4	2	
	28	★	MHS0295L090B	83.2	90.6	92.6	140.6	140	0.6	4	2	
3.0	4	●	MHS0300L020B	12.5	19.5	20.5	70.5	70	0.5	4	3	
	10	●	MHS0300L040B	30.5	39.5	40.5	90.5	90	0.5	4	4	
	17	●	MHS0300L060B	51.5	59.5	60.5	110.5	110	0.5	4	4	
	27	●	MHS0300L090B	81.5	89.5	90.5	140.5	140	0.5	4	4	
3.1	4	□	MHS0310L020B	12.9	20.0	20.5	70.5	70	0.5	4	3	
	10	□	MHS0310L040B	31.6	40.1	40.6	90.6	90	0.6	4	4	
	17	□	MHS0310L060B	53.3	60.1	60.6	110.6	110	0.6	4	4	
	26	□	MHS0310L090B	81.2	90.1	90.6	140.6	140	0.6	4	4	
3.2	4	□	MHS0320L020B	13.4	20.1	20.6	70.6	70	0.6	4	3	
	10	□	MHS0320L040B	32.6	40.1	40.6	90.6	90	0.6	4	4	
	16	□	MHS0320L060B	51.8	60.1	60.6	110.6	110	0.6	4	4	
	25	□	MHS0320L090B	80.6	90.1	90.6	140.6	140	0.6	4	4	
3.3	3	□	MHS0330L020B	10.5	20.1	20.6	70.6	70	0.6	4	3	
	9	□	MHS0330L040B	30.3	40.1	40.6	90.6	90	0.6	4	4	
	16	□	MHS0330L060B	53.4	60.1	60.6	110.6	110	0.6	4	4	
	25	□	MHS0330L090B	83.1	90.1	90.6	140.6	140	0.6	4	4	
3.4	3	□	MHS0340L020B	10.8	20.1	20.6	70.6	70	0.6	4	3	
	9	□	MHS0340L040B	31.2	40.1	40.6	90.6	90	0.6	4	4	
	15	□	MHS0340L060B	51.6	60.1	60.6	110.6	110	0.6	4	4	
	24	□	MHS0340L090B	82.2	90.1	90.6	140.6	140	0.6	4	4	
3.5	3	●	MHS0350L020B	11.1	20.1	20.6	70.6	70	0.6	4	3	
	9	●	MHS0350L040B	32.1	40.1	40.6	90.6	90	0.6	4	4	
	14	●	MHS0350L060B	49.6	60.1	60.6	110.6	110	0.6	4	4	
	23	●	MHS0350L090B	81.1	90.1	90.6	140.6	140	0.6	4	4	

DC (мм)	Глубина сверления (LD)	VP15TF	Обозначение	Размеры (мм)							Тип
				LU	LCF	LH	OAL	LF	PL	DCON	
3.6	3	□	MHS0360L020B	11.4	20.6	20.6	70.6	70	0.6	4	3
	9	□	MHS0360L040B	33.1	40.7	40.7	90.7	90	0.7	4	4
	14	□	MHS0360L060B	51.1	60.7	60.7	110.7	110	0.7	4	4
	22	□	MHS0360L090B	79.9	90.7	90.7	140.7	140	0.7	4	4
	30	□	MHS0360L120B	108.7	120.7	120.7	170.7	170	0.7	4	4
3.7	3	□	MHS0370L020B	11.7	20.6	20.6	70.6	70	0.6	4	3
	8	□	MHS0370L040B	30.3	40.7	40.7	90.7	90	0.7	4	4
	14	□	MHS0370L060B	52.5	60.7	60.7	110.7	110	0.7	4	4
	22	□	MHS0370L090B	82.1	90.7	90.7	140.7	140	0.7	4	4
3.8	3	★	MHS0380L020B	12.1	20.7	20.7	70.7	70	0.7	4	3
	8	★	MHS0380L040B	31.1	40.7	40.7	90.7	90	0.7	4	4
	13	★	MHS0380L060B	50.1	60.7	60.7	110.7	110	0.7	4	4
	21	★	MHS0380L090B	80.5	90.7	90.7	140.7	140	0.7	4	4
	29	★	MHS0380L120B	110.9	120.7	120.7	170.7	170	0.7	4	4
3.9	3	★	MHS0390L020B	12.4	20.7	20.7	70.7	70	0.7	4	3
	8	★	MHS0390L040B	31.9	40.7	40.7	90.7	90	0.7	4	4
	13	★	MHS0390L060B	51.4	60.7	60.7	110.7	110	0.7	4	4
	21	□	MHS0390L090B	82.6	90.7	90.7	140.7	140	0.7	4	4
	28	□	MHS0390L120B	109.9	120.7	120.7	170.7	170	0.7	4	4
4.0	2	●	MHS0400L020B	8.7	20.7	20.7	70.7	70	0.7	4	3
	7	●	MHS0400L040B	28.7	40.7	40.7	90.7	90	0.7	4	4
	12	●	MHS0400L060B	48.7	60.7	60.7	110.7	110	0.7	4	4
	20	●	MHS0400L090B	80.7	90.7	90.7	140.7	140	0.7	4	4
	27	●	MHS0400L120B	108.7	120.7	120.7	170.7	170	0.7	4	4
4.1	2	□	MHS0410L020B	8.9	19.2	20.7	70.7	70	0.7	6	3
	7	□	MHS0410L040B	29.4	39.2	40.7	90.7	90	0.7	6	4
	12	□	MHS0410L060B	49.9	59.2	60.7	110.7	110	0.7	6	4
	19	□	MHS0410L090B	78.6	89.2	90.7	140.7	140	0.7	6	4
	26	□	MHS0410L120B	107.3	119.2	120.7	170.7	170	0.7	6	4
4.2	2	□	MHS0420L020B	9.1	19.2	20.7	70.7	70	0.7	6	3
	7	□	MHS0420L040B	30.2	39.3	40.8	90.8	90	0.8	6	4
	11	□	MHS0420L060B	47.0	59.3	60.8	110.8	110	0.8	6	4
	19	□	MHS0420L090B	80.6	89.3	90.8	140.8	140	0.8	6	4
	26	□	MHS0420L120B	110.0	119.3	120.8	170.8	170	0.8	6	4
4.3	2	□	MHS0430L020B	9.3	19.2	20.7	70.7	70	0.7	6	3
	6	□	MHS0430L040B	26.6	39.3	40.8	90.8	90	0.8	6	4
	11	□	MHS0430L060B	48.1	59.3	60.8	110.8	110	0.8	6	4
	18	□	MHS0430L090B	78.2	89.3	90.8	140.8	140	0.8	6	4
	25	□	MHS0430L120B	108.3	119.3	120.8	170.8	170	0.8	6	4
4.4	2	★	MHS0440L020B	9.6	19.3	20.8	70.8	70	0.8	6	3
	6	□	MHS0440L040B	27.2	39.3	40.8	90.8	90	0.8	6	4
	11	□	MHS0440L060B	49.2	59.3	60.8	110.8	110	0.8	6	4
	18	□	MHS0440L090B	80.0	89.3	90.8	140.8	140	0.8	6	4
	24	□	MHS0440L120B	106.4	119.3	120.8	170.8	170	0.8	6	4
4.5	2	●	MHS0450L020B	9.8	19.3	20.8	70.8	70	0.8	6	3
	6	●	MHS0450L040B	27.8	39.3	40.8	90.8	90	0.8	6	4
	10	●	MHS0450L060B	45.8	59.3	60.8	110.8	110	0.8	6	4
	17	●	MHS0450L090B	77.3	89.3	90.8	140.8	140	0.8	6	4
	24	●	MHS0450L120B	108.8	119.3	120.8	170.8	170	0.8	6	4

DC (мм)	Глубина сверления (LD)	VP15TF	Обозначение	Размеры (мм)							Тип
				LU	LCF	LH	OAL	LF	PL	DCON	
4.6	2	□	MHS0460L020B	10.0	19.8	20.8	70.8	70	0.8	6	3
	6	□	MHS0460L040B	28.4	39.8	40.8	90.8	90	0.8	6	4
	10	□	MHS0460L060B	46.8	59.8	60.8	110.8	110	0.8	6	4
	17	□	MHS0460L090B	79.0	89.8	90.8	140.8	140	0.8	6	4
	23	□	MHS0460L120B	106.6	119.8	120.8	170.8	170	0.8	6	4
	30	□	MHS0460L150B	138.8	149.8	150.8	200.8	200	0.8	6	4
4.7	2	□	MHS0470L020B	10.2	19.8	20.8	70.8	70	0.8	6	3
	6	□	MHS0470L040B	29.1	39.9	40.9	90.9	90	0.9	6	4
	10	□	MHS0470L060B	47.9	59.9	60.9	110.9	110	0.9	6	4
	16	□	MHS0470L090B	76.1	89.9	90.9	140.9	140	0.9	6	4
	23	□	MHS0470L120B	109.0	119.9	120.9	170.9	170	0.9	6	4
	29	□	MHS0470L150B	137.2	149.9	150.9	200.9	200	0.9	6	4
4.8	1	★	MHS0480L020B	5.6	19.8	20.8	70.8	70	0.8	6	3
	6	★	MHS0480L040B	29.7	39.9	40.9	90.9	90	0.9	6	4
	10	★	MHS0480L060B	48.9	59.9	60.9	110.9	110	0.9	6	4
	16	★	MHS0480L090B	77.7	89.9	90.9	140.9	140	0.9	6	4
	22	★	MHS0480L120B	106.5	119.9	120.9	170.9	170	0.9	6	4
4.9	1	□	MHS0490L020B	5.7	19.8	20.8	70.8	70	0.8	6	3
	5	□	MHS0490L040B	25.4	39.9	40.9	90.9	90	0.9	6	4
	10	□	MHS0490L060B	49.9	59.9	60.9	110.9	110	0.9	6	4
	16	□	MHS0490L090B	79.3	89.9	90.9	140.9	140	0.9	6	4
	22	□	MHS0490L120B	108.7	119.9	120.9	170.9	170	0.9	6	4
	28	□	MHS0490L150B	138.1	149.9	150.9	200.9	200	0.9	6	4
5.0	1	●	MHS0500L020B	5.9	19.9	20.9	70.9	70	0.9	6	3
	5	●	MHS0500L040B	25.9	39.9	40.9	90.9	90	0.9	6	4
	9	●	MHS0500L060B	45.9	59.9	60.9	110.9	110	0.9	6	4
	15	●	MHS0500L090B	75.9	89.9	90.9	140.9	140	0.9	6	4
	21	●	MHS0500L120B	105.9	119.9	120.9	170.9	170	0.9	6	4
	27	●	MHS0500L150B	135.9	149.9	150.9	200.9	200	0.9	6	4
5.1	3	□	MHS0510L030B	16.2	30.4	30.9	80.9	80	0.9	6	3
	9	□	MHS0510L060B	46.8	60.4	60.9	110.9	110	0.9	6	4
	15	□	MHS0510L090B	77.4	90.4	90.9	140.9	140	0.9	6	4
	21	□	MHS0510L120B	108.0	120.4	120.9	170.9	170	0.9	6	4
	27	□	MHS0510L150B	138.6	150.4	150.9	200.9	200	0.9	6	4
5.2	3	□	MHS0520L030B	16.5	30.4	30.9	80.9	80	0.9	6	3
	9	□	MHS0520L060B	47.7	60.4	60.9	110.9	110	0.9	6	4
	15	□	MHS0520L090B	78.9	90.4	90.9	140.9	140	0.9	6	4
	20	□	MHS0520L120B	104.9	120.4	120.9	170.9	170	0.9	6	4
	26	□	MHS0520L150B	136.1	150.4	150.9	200.9	200	0.9	6	4
5.3	3	□	MHS0530L030B	16.8	30.4	30.9	80.9	80	0.9	6	3
	9	□	MHS0530L060B	48.7	60.5	61.0	111.0	110	1.0	6	4
	14	★	MHS0530L090B	75.2	90.5	91.0	141.0	140	1.0	6	4
	20	□	MHS0530L120B	107.0	120.5	121.0	171.0	170	1.0	6	4
	26	□	MHS0530L150B	138.8	150.5	151.0	201.0	200	1.0	6	4
5.4	3	□	MHS0540L030B	17.1	30.4	30.9	80.9	80	0.9	6	3
	9	□	MHS0540L060B	49.6	60.5	61.0	111.0	110	1.0	6	4
	14	□	MHS0540L090B	76.6	90.5	91.0	141.0	140	1.0	6	4
	20	□	MHS0540L120B	109.0	120.5	121.0	171.0	170	1.0	6	4
	25	□	MHS0540L150B	136.0	150.5	151.0	201.0	200	1.0	6	4

Примечание 1) Пожалуйста, свяжитесь с нами если Вы не нашли нужную геометрию в данном каталоге (могут быть заказаны другие диаметры и длины).

● : Есть на складе. ★ : Со склада в Японии.

□ : Нет на складе, выпускается исключительно под заказ.

DC	Глубина сверления (мм)	VP15TF	Обозначение	Размеры (мм)							Тип
				LU	LCF	LH	OAL	LF	PL	DCON	
5.5	3	●	MHS0550L030B	17.4	30.4	30.9	80.9	80	0.9	6	3
	8	●	MHS0550L060B	45.0	60.5	61.0	111.0	110	1.0	6	4
	14	●	MHS0550L090B	78.0	90.5	91.0	141.0	140	1.0	6	4
	19	●	MHS0550L120B	105.5	120.5	121.0	171.0	170	1.0	6	4
	25	●	MHS0550L150B	138.5	150.5	151.0	201.0	200	1.0	6	4
5.6	3	□	MHS0560L030B	17.8	31.0	31.0	81.0	80	1.0	6	3
	8	□	MHS0560L060B	45.8	61.0	61.0	111.0	110	1.0	6	4
	14	□	MHS0560L090B	79.4	91.0	91.0	141.0	140	1.0	6	4
	19	□	MHS0560L120B	107.4	121.0	121.0	171.0	170	1.0	6	4
	24	□	MHS0560L150B	135.4	151.0	151.0	201.0	200	1.0	6	4
5.7	3	□	MHS0570L030B	18.1	31.0	31.0	81.0	80	1.0	6	3
	8	□	MHS0570L060B	46.6	61.0	61.0	111.0	110	1.0	6	4
	13	□	MHS0570L090B	75.1	91.0	91.0	141.0	140	1.0	6	4
	19	□	MHS0570L120B	109.3	121.0	121.0	171.0	170	1.0	6	4
	24	□	MHS0570L150B	137.8	151.0	151.0	201.0	200	1.0	6	4
5.8	3	★	MHS0580L030B	18.4	31.0	31.0	81.0	80	1.0	6	3
	8	★	MHS0580L060B	47.5	61.1	61.1	111.1	110	1.1	6	4
	13	★	MHS0580L090B	76.5	91.1	91.1	141.1	140	1.1	6	4
	18	★	MHS0580L120B	105.5	121.1	121.1	171.1	170	1.1	6	4
	23	★	MHS0580L150B	134.5	151.1	151.1	201.1	200	1.1	6	4
5.9	3	□	MHS0590L030B	18.7	31.0	31.0	81.0	80	1.0	6	3
	8	□	MHS0590L060B	48.3	61.1	61.1	111.1	110	1.1	6	4
	13	□	MHS0590L090B	77.8	91.1	91.1	141.1	140	1.1	6	4
	18	□	MHS0590L120B	107.3	121.1	121.1	171.1	170	1.1	6	4
	23	□	MHS0590L150B	136.8	151.1	151.1	201.1	200	1.1	6	4
6.0	2	●	MHS0600L030B	13.0	29.6	31.1	81.1	80	1.1	8	3
	7	●	MHS0600L060B	43.1	61.1	61.1	111.1	110	1.1	6	4
	12	●	MHS0600L090B	73.1	91.1	91.1	141.1	140	1.1	6	4
	17	●	MHS0600L120B	103.1	121.1	121.1	171.1	170	1.1	6	4
	22	●	MHS0600L150B	133.1	151.1	151.1	201.1	200	1.1	6	4
6.1	2	□	MHS0610L030B	13.3	29.6	31.1	81.1	80	1.1	8	3
	7	□	MHS0610L060B	43.8	61.1	61.1	111.1	110	1.1	6	4
	12	□	MHS0610L090B	74.3	91.1	91.1	141.1	140	1.1	6	4
	17	□	MHS0610L120B	104.8	121.1	121.1	171.1	170	1.1	6	4
	22	□	MHS0610L150B	135.3	151.1	151.1	201.1	200	1.1	6	4
6.2	2	□	MHS0620L030B	13.5	29.6	31.1	81.1	80	1.1	8	3
	7	□	MHS0620L060B	44.5	61.1	61.1	111.1	110	1.1	6	4
	12	□	MHS0620L090B	75.5	91.1	91.1	141.1	140	1.1	6	4
	17	□	MHS0620L120B	106.5	121.1	121.1	171.1	170	1.1	6	4
	21	□	MHS0620L150B	131.3	149.6	151.1	201.1	200	1.1	6	4
6.3	2	□	MHS0630L030B	13.7	29.6	31.1	81.1	80	1.1	8	3
	7	□	MHS0630L060B	45.2	61.1	61.1	111.1	110	1.1	6	4
	12	□	MHS0630L090B	76.7	91.1	91.1	141.1	140	1.1	6	4
	16	□	MHS0630L120B	101.9	119.6	121.1	171.1	170	1.1	6	4
	21	□	MHS0630L150B	133.4	149.6	151.1	201.1	200	1.1	6	4
6.4	2	□	MHS0640L030B	13.9	29.6	31.1	81.1	80	1.1	8	3
	7	□	MHS0640L060B	46.0	61.1	61.2	111.2	110	1.2	6	4
	11	□	MHS0640L090B	71.6	89.7	91.2	141.2	140	1.2	6	4
	16	□	MHS0640L120B	103.6	119.7	121.2	171.2	170	1.2	6	4
	21	□	MHS0640L150B	135.6	149.7	151.2	201.2	200	1.2	6	4

DC	Глубина сверления (мм)	VP15TF	Обозначение	Размеры (мм)							Тип
				LU	LCF	LH	OAL	LF	PL	DCON	
6.5	2	●	MHS0650L030B	14.1	29.6	31.1	81.1	80	1.1	8	3
	6	●	MHS0650L060B	40.2	59.7	61.2	111.2	110	1.2	8	4
	11	●	MHS0650L090B	72.7	89.7	91.2	141.2	140	1.2	8	4
	16	●	MHS0650L120B	105.2	119.7	121.2	171.2	170	1.2	8	4
	20	●	MHS0650L150B	131.2	149.7	151.2	201.2	200	1.2	8	4
6.6	2	□	MHS0660L030B	14.3	30.1	31.1	81.1	80	1.1	8	3
	6	□	MHS0660L060B	40.8	60.2	61.2	111.2	110	1.2	8	4
	11	□	MHS0660L090B	73.8	90.2	91.2	141.2	140	1.2	8	4
	16	□	MHS0660L120B	106.8	120.2	121.2	171.2	170	1.2	8	4
	20	□	MHS0660L150B	133.2	150.2	151.2	201.2	200	1.2	8	4
6.7	2	□	MHS0670L030B	14.6	30.2	31.2	81.2	80	1.2	8	3
	6	□	MHS0670L060B	41.4	60.2	61.2	111.2	110	1.2	8	4
	11	□	MHS0670L090B	74.9	90.2	91.2	141.2	140	1.2	8	4
	15	□	MHS0670L120B	101.7	120.2	121.2	171.2	170	1.2	8	4
	20	□	MHS0670L150B	135.2	150.2	151.2	201.2	200	1.2	8	4
6.8	2	★	MHS0680L030B	14.8	30.2	31.2	81.2	80	1.2	8	3
	6	★	MHS0680L060B	42.0	60.2	61.2	111.2	110	1.2	8	4
	11	★	MHS0680L090B	76.0	90.2	91.2	141.2	140	1.2	8	4
	15	★	MHS0680L120B	103.2	120.2	121.2	171.2	170	1.2	8	4
	19	★	MHS0680L150B	130.4	150.2	151.2	201.2	200	1.2	8	4
6.9	2	□	MHS0690L030B	15.0	30.2	31.2	81.2	80	1.2	8	3
	6	□	MHS0690L060B	42.7	60.3	61.3	111.3	110	1.3	8	4
	10	□	MHS0690L090B	70.3	90.3	91.3	141.3	140	1.3	8	4
	15	□	MHS0690L120B	104.8	120.3	121.3	171.3	170	1.3	8	4
	19	□	MHS0690L150B	132.4	150.3	151.3	201.3	200	1.3	8	4
7.0	2	●	MHS0700L030B	15.2	30.2	31.2	81.2	80	1.2	8	3
	6	●	MHS0700L060B	43.3	60.3	61.3	111.3	110	1.3	8	4
	10	●	MHS0700L090B	71.3	90.3	91.3	141.3	140	1.3	8	4
	14	●	MHS0700L120B	99.3	120.3	121.3	171.3	170	1.3	8	4
	19	●	MHS0700L150B	134.3	150.3	151.3	201.3	200	1.3	8	4
7.1	2	□	MHS0710L030B	15.4	30.7	31.2	81.2	80	1.2	8	3
	6	□	MHS0710L060B	43.9	60.8	61.3	111.3	110	1.3	8	4
	10	□	MHS0710L090B	72.3	90.8	91.3	141.3	140	1.3	8	4
	14	□	MHS0710L120B	100.7	120.8	121.3	171.3	170	1.3	8	4
	19	□	MHS0710L150B	136.2	150.8	151.3	201.3	200	1.3	8	4
7.2	2	□	MHS0720L030B	15.6	30.7	31.2	81.2	80	1.2	8	3
	6	□	MHS0720L060B	44.5	60.8	61.3	111.3	110	1.3	8	4
	10	□	MHS0720L090B	73.3	90.8	91.3	141.3	140	1.3	8	4
	14	□	MHS0720L120B	102.1	120.8	121.3	171.3	170	1.3	8	4
	18	□	MHS0720L150B	130.9	150.8	151.3	201.3	200	1.3	8	4
7.2	25	□	MHS0720L200B	181.3	200.8	201.3	251.3	250	1.3	8	4

ИНСТРУМЕНТ ДЛЯ СВЕРЛЕНИЯ (МОНОЛИТНЫЕ ТВЕРДОСПЛАВНЫЕ СВЕРЛА)

MHS

ТВЕРДЫЙ СПЛАВ

ИНСТРУМЕНТ ДЛЯ СВЕРЛЕНИЯ

M

DC (мм)	Глубина сверления (L/D)	VP15TF	Обозначение	Размеры (мм)							Тип
				LU	LCF	LH	OAL	LF	PL	DCON	
7.3	2	□	MHS0730L030B	15.9	30.8	31.3	81.3	80	1.3	8	3
	6	□	MHS0730L060B	45.1	60.8	61.3	111.3	110	1.3	8	4
	10	□	MHS0730L090B	74.3	90.8	91.3	141.3	140	1.3	8	4
	14	□	MHS0730L120B	103.5	120.8	121.3	171.3	170	1.3	8	4
	18	□	MHS0730L150B	132.7	150.8	151.3	201.3	200	1.3	8	4
	25	□	MHS0730L200B	183.8	200.8	201.3	251.3	250	1.3	8	4
7.4	1	□	MHS0740L030B	8.7	30.8	31.3	81.3	80	1.3	8	3
	6	□	MHS0740L060B	45.7	60.8	61.3	111.3	110	1.3	8	4
	10	□	MHS0740L090B	75.3	90.8	91.3	141.3	140	1.3	8	4
	14	□	MHS0740L120B	104.9	120.8	121.3	171.3	170	1.3	8	4
	18	□	MHS0740L150B	134.5	150.8	151.3	201.3	200	1.3	8	4
	24	□	MHS0740L200B	178.9	200.8	201.3	251.3	250	1.3	8	4
7.5	1	●	MHS0750L030B	8.8	30.8	31.3	81.3	80	1.3	8	3
	5	●	MHS0750L060B	38.9	60.9	61.4	111.4	110	1.4	8	4
	9	●	MHS0750L090B	68.9	90.9	91.4	141.4	140	1.4	8	4
	13	●	MHS0750L120B	98.9	120.9	121.4	171.4	170	1.4	8	4
	17	●	MHS0750L150B	128.9	150.9	151.4	201.4	200	1.4	8	4
	24	●	MHS0750L200B	181.4	200.9	201.4	251.4	250	1.4	8	4
7.6	1	□	MHS0760L030B	8.9	31.3	31.3	81.3	80	1.3	8	3
	5	□	MHS0760L060B	39.4	61.4	61.4	111.4	110	1.4	8	4
	9	□	MHS0760L090B	69.8	91.4	91.4	141.4	140	1.4	8	4
	13	□	MHS0760L120B	100.2	121.4	121.4	171.4	170	1.4	8	4
	17	□	MHS0760L150B	130.6	151.4	151.4	201.4	200	1.4	8	4
	24	□	MHS0760L200B	183.8	201.4	201.4	251.4	250	1.4	8	4
30	□	MHS0760L250B	229.4	251.4	251.4	301.4	300	1.4	8	4	
7.7	1	□	MHS0770L030B	9.0	31.3	31.3	81.3	80	1.3	8	3
	5	□	MHS0770L060B	39.9	61.4	61.4	111.4	110	1.4	8	4
	9	□	MHS0770L090B	70.7	91.4	91.4	141.4	140	1.4	8	4
	13	□	MHS0770L120B	101.5	121.4	121.4	171.4	170	1.4	8	4
	17	□	MHS0770L150B	132.3	151.4	151.4	201.4	200	1.4	8	4
	23	□	MHS0770L200B	178.5	201.4	201.4	251.4	250	1.4	8	4
30	□	MHS0770L250B	232.4	251.4	251.4	301.4	300	1.4	8	4	
7.8	1	★	MHS0780L030B	9.1	31.3	31.3	81.3	80	1.3	8	3
	5	★	MHS0780L060B	40.4	61.4	61.4	111.4	110	1.4	8	4
	9	★	MHS0780L090B	71.6	91.4	91.4	141.4	140	1.4	8	4
	13	★	MHS0780L120B	102.8	121.4	121.4	171.4	170	1.4	8	4
	17	★	MHS0780L150B	134.0	151.4	151.4	201.4	200	1.4	8	4
	23	★	MHS0780L200B	180.8	201.4	201.4	251.4	250	1.4	8	4
30	★	MHS0780L250B	235.4	251.4	251.4	301.4	300	1.4	8	4	
7.9	1	□	MHS0790L030B	9.3	31.4	31.4	81.4	80	1.4	8	3
	5	□	MHS0790L060B	40.9	61.4	61.4	111.4	110	1.4	8	4
	9	□	MHS0790L090B	72.5	91.4	91.4	141.4	140	1.4	8	4
	13	□	MHS0790L120B	104.1	121.4	121.4	171.4	170	1.4	8	4
	16	□	MHS0790L150B	127.8	151.4	151.4	201.4	200	1.4	8	4
	23	□	MHS0790L200B	183.1	201.4	201.4	251.4	250	1.4	8	4
29	□	MHS0790L250B	230.5	251.4	251.4	301.4	300	1.4	8	4	

DC (мм)	Глубина сверления (L/D)	VP15TF	Обозначение	Размеры (мм)							Тип
				LU	LCF	LH	OAL	LF	PL	DCON	
8.0	1	●	MHS0800L030B	9.4	31.4	31.4	81.4	80	1.4	8	3
	5	●	MHS0800L060B	41.5	61.5	61.5	111.5	110	1.5	8	4
	9	●	MHS0800L090B	73.5	91.5	91.5	141.5	140	1.5	8	4
	12	●	MHS0800L120B	97.5	121.5	121.5	171.5	170	1.5	8	4
	16	●	MHS0800L150B	129.5	151.5	151.5	201.5	200	1.5	8	4
	22	●	MHS0800L200B	177.5	201.5	201.5	251.5	250	1.5	8	4
	29	●	MHS0800L250B	233.5	251.5	251.5	301.5	300	1.5	8	4
8.1	2	□	MHS0810L040B	17.6	39.9	41.4	101.4	100	1.4	10	3
	8	□	MHS0810L090B	66.3	90.0	91.5	151.5	150	1.5	10	4
	12	□	MHS0810L120B	98.7	120.0	121.5	181.5	180	1.5	10	4
	16	□	MHS0810L150B	131.1	150.0	151.5	211.5	210	1.5	10	4
	22	□	MHS0810L200B	179.7	200.0	201.5	261.5	260	1.5	10	4
	28	□	MHS0810L250B	228.3	250.0	251.5	311.5	310	1.5	10	4
8.2	2	□	MHS0820L040B	17.8	39.9	41.4	101.4	100	1.4	10	3
	8	□	MHS0820L090B	67.1	90.0	91.5	151.5	150	1.5	10	4
	12	□	MHS0820L120B	99.9	120.0	121.5	181.5	180	1.5	10	4
	16	□	MHS0820L150B	132.7	150.0	151.5	211.5	210	1.5	10	4
	22	□	MHS0820L200B	181.9	200.0	201.5	261.5	260	1.5	10	4
	28	□	MHS0820L250B	231.1	250.0	251.5	311.5	310	1.5	10	4
8.3	2	□	MHS0830L040B	18.0	39.9	41.4	101.4	100	1.4	10	3
	8	□	MHS0830L090B	67.9	90.0	91.5	151.5	150	1.5	10	4
	12	□	MHS0830L120B	101.1	120.0	121.5	181.5	180	1.5	10	4
	15	□	MHS0830L150B	126.0	150.0	151.5	211.5	210	1.5	10	4
	21	□	MHS0830L200B	175.8	200.0	201.5	261.5	260	1.5	10	4
	27	□	MHS0830L250B	225.6	250.0	251.5	311.5	310	1.5	10	4
8.4	2	□	MHS0840L040B	18.2	39.9	41.4	101.4	100	1.4	10	3
	8	□	MHS0840L090B	68.7	90.0	91.5	151.5	150	1.5	10	4
	12	□	MHS0840L120B	102.3	120.0	121.5	181.5	180	1.5	10	4
	15	□	MHS0840L150B	127.5	150.0	151.5	211.5	210	1.5	10	4
	21	□	MHS0840L200B	177.9	200.0	201.5	261.5	260	1.5	10	4
	27	□	MHS0840L250B	228.3	250.0	251.5	311.5	310	1.5	10	4
8.5	2	●	MHS0850L040B	18.5	40.0	41.5	101.5	100	1.5	10	3
	8	●	MHS0850L090B	69.5	90.0	91.5	151.5	150	1.5	10	4
	11	●	MHS0850L120B	95.0	120.0	121.5	181.5	180	1.5	10	4
	15	●	MHS0850L150B	129.0	150.0	151.5	211.5	210	1.5	10	4
	21	●	MHS0850L200B	180.0	200.0	201.5	261.5	260	1.5	10	4
	27	●	MHS0850L250B	231.0	250.0	251.5	311.5	310	1.5	10	4
8.6	2	□	MHS0860L040B	18.7	40.5	41.5	101.5	100	1.5	10	3
	8	□	MHS0860L090B	70.4	90.6	91.6	151.6	150	1.6	10	4
	11	□	MHS0860L120B	96.2	120.6	121.6	181.6	180	1.6	10	4
	15	□	MHS0860L150B	130.6	150.6	151.6	211.6	210	1.6	10	4
	21	□	MHS0860L200B	182.2	200.6	201.6	261.6	260	1.6	10	4
	26	□	MHS0860L250B	225.2	250.6	251.6	311.6	310	1.6	10	4
8.7	2	□	MHS0870L040B	18.9	40.5	41.5	101.5	100	1.5	10	3
	8	□	MHS0870L090B	71.2	90.6	91.6	151.6	150	1.6	10	4
	11	□	MHS0870L120B	97.3	120.6	121.6	181.6	180	1.6	10	4
	15	□	MHS0870L150B	132.1	150.6	151.6	211.6	210	1.6	10	4
	20	□	MHS0870L200B	175.6	200.6	201.6	261.6	260	1.6	10	4
	26	□	MHS0870L250B	227.8	250.6	251.6	311.6	310	1.6	10	4

Примечание 1) Пожалуйста, свяжитесь с нами если Вы не нашли нужную геометрию в данном каталоге (могут быть заказаны другие диаметры и длины).

● : Есть на складе. ★ : Со склада в Японии.

□ : Нет на складе, выпускается исключительно под заказ.

DC	Глубина сверления (L/D)	VP15TF	Обозначение	Размеры (мм)							Тип
				LU	LCF	LH	OAL	LF	PL	DCON	
8.8	2	★	MHS0880L040B	19.1	40.5	41.5	101.5	100	1.5	10	3
	8	★	MHS0880L090B	72.0	90.6	91.6	151.6	150	1.6	10	4
	11	★	MHS0880L120B	98.4	120.6	121.6	181.6	180	1.6	10	4
	14	★	MHS0880L150B	124.8	150.6	151.6	211.6	210	1.6	10	4
	20	★	MHS0880L200B	177.6	200.6	201.6	261.6	260	1.6	10	4
	26	★	MHS0880L250B	230.4	250.6	251.6	311.6	310	1.6	10	4
8.9	2	□	MHS0890L040B	19.3	40.5	41.5	101.5	100	1.5	10	3
	7	□	MHS0890L090B	63.9	90.6	91.6	151.6	150	1.6	10	4
	11	□	MHS0890L120B	99.5	120.6	121.6	181.6	180	1.6	10	4
	14	□	MHS0890L150B	126.2	150.6	151.6	211.6	210	1.6	10	4
	20	□	MHS0890L200B	179.6	200.6	201.6	261.6	260	1.6	10	4
	25	□	MHS0890L250B	224.1	250.6	251.6	311.6	310	1.6	10	4
9.0	2	●	MHS0900L040B	19.5	40.5	41.5	101.5	100	1.5	10	3
	7	●	MHS0900L090B	64.6	90.6	91.6	151.6	150	1.6	10	4
	11	●	MHS0900L120B	100.6	120.6	121.6	181.6	180	1.6	10	4
	14	●	MHS0900L150B	127.6	150.6	151.6	211.6	210	1.6	10	4
	20	●	MHS0900L200B	181.6	200.6	201.6	261.6	260	1.6	10	4
	25	●	MHS0900L250B	226.6	250.6	251.6	311.6	310	1.6	10	4
9.1	2	□	MHS0910L040B	19.8	41.1	41.6	101.6	100	1.6	10	3
	7	□	MHS0910L090B	65.4	91.2	91.7	151.7	150	1.7	10	4
	11	□	MHS0910L120B	101.8	121.2	121.7	181.7	180	1.7	10	4
	14	□	MHS0910L150B	129.1	151.2	151.7	211.7	210	1.7	10	4
	19	□	MHS0910L200B	174.6	201.2	201.7	261.7	260	1.7	10	4
	25	□	MHS0910L250B	229.2	251.2	251.7	311.7	310	1.7	10	4
30	□	MHS0910L300B	274.7	301.2	301.7	361.7	360	1.7	10	4	
9.2	2	□	MHS0920L040B	20.0	41.1	41.6	101.6	100	1.6	10	3
	7	□	MHS0920L090B	66.1	91.2	91.7	151.7	150	1.7	10	4
	10	□	MHS0920L120B	93.7	121.2	121.7	181.7	180	1.7	10	4
	14	□	MHS0920L150B	130.5	151.2	151.7	211.7	210	1.7	10	4
	19	□	MHS0920L200B	176.5	201.2	201.7	261.7	260	1.7	10	4
	25	□	MHS0920L250B	231.7	251.2	251.7	311.7	310	1.7	10	4
30	□	MHS0920L300B	277.7	301.2	301.7	361.7	360	1.7	10	4	
9.3	2	□	MHS0930L040B	20.2	41.1	41.6	101.6	100	1.6	10	3
	7	□	MHS0930L090B	66.8	91.2	91.7	151.7	150	1.7	10	4
	10	□	MHS0930L120B	94.7	121.2	121.7	181.7	180	1.7	10	4
	14	□	MHS0930L150B	131.9	151.2	151.7	211.7	210	1.7	10	4
	19	□	MHS0930L200B	178.4	201.2	201.7	261.7	260	1.7	10	4
	24	□	MHS0930L250B	224.9	251.2	251.7	311.7	310	1.7	10	4
30	□	MHS0930L300B	280.7	301.2	301.7	361.7	360	1.7	10	4	
9.4	2	□	MHS0940L040B	20.4	41.1	41.6	101.6	100	1.6	10	3
	7	□	MHS0940L090B	67.5	91.2	91.7	151.7	150	1.7	10	4
	10	□	MHS0940L120B	95.7	121.2	121.7	181.7	180	1.7	10	4
	13	□	MHS0940L150B	123.9	151.2	151.7	211.7	210	1.7	10	4
	19	□	MHS0940L200B	180.3	201.2	201.7	261.7	260	1.7	10	4
	24	□	MHS0940L250B	227.3	251.2	251.7	311.7	310	1.7	10	4
29	□	MHS0940L300B	274.3	301.2	301.7	361.7	360	1.7	10	4	

DC	Глубина сверления (L/D)	VP15TF	Обозначение	Размеры (мм)							Тип
				LU	LCF	LH	OAL	LF	PL	DCON	
9.5	2	★	MHS0950L040B	20.6	41.1	41.6	101.6	100	1.6	10	3
	7	★	MHS0950L090B	68.2	91.2	91.7	151.7	150	1.7	10	4
	10	★	MHS0950L120B	96.7	121.2	121.7	181.7	180	1.7	10	4
	13	★	MHS0950L150B	125.2	151.2	151.7	211.7	210	1.7	10	4
	18	★	MHS0950L200B	172.7	201.2	201.7	261.7	260	1.7	10	4
	24	★	MHS0950L250B	229.7	251.2	251.7	311.7	310	1.7	10	4
	29	★	MHS0950L300B	277.2	301.2	301.7	361.7	360	1.7	10	4
9.6	2	□	MHS0960L040B	20.9	41.7	41.7	101.7	100	1.7	10	3
	7	□	MHS0960L090B	68.9	91.7	91.7	151.7	150	1.7	10	4
	10	□	MHS0960L120B	97.7	121.7	121.7	181.7	180	1.7	10	4
	13	□	MHS0960L150B	126.5	151.7	151.7	211.7	210	1.7	10	4
	18	□	MHS0960L200B	174.5	201.7	201.7	261.7	260	1.7	10	4
	24	□	MHS0960L250B	232.1	251.7	251.7	311.7	310	1.7	10	4
	29	□	MHS0960L300B	280.1	301.7	301.7	361.7	360	1.7	10	4
9.7	2	□	MHS0970L040B	21.1	41.7	41.7	101.7	100	1.7	10	3
	7	□	MHS0970L090B	69.7	91.8	91.8	151.8	150	1.8	10	4
	10	□	MHS0970L120B	98.8	121.8	121.8	181.8	180	1.8	10	4
	13	□	MHS0970L150B	127.9	151.8	151.8	211.8	210	1.8	10	4
	18	□	MHS0970L200B	176.4	201.8	201.8	261.8	260	1.8	10	4
	23	□	MHS0970L250B	224.9	251.8	251.8	311.8	310	1.8	10	4
	28	□	MHS0970L300B	273.4	301.8	301.8	361.8	360	1.8	10	4
9.8	2	★	MHS0980L040B	21.3	41.7	41.7	101.7	100	1.7	10	3
	7	★	MHS0980L090B	70.4	91.8	91.8	151.8	150	1.8	10	4
	10	★	MHS0980L120B	99.8	121.8	121.8	181.8	180	1.8	10	4
	13	★	MHS0980L150B	129.2	151.8	151.8	211.8	210	1.8	10	4
	18	★	MHS0980L200B	178.2	201.8	201.8	261.8	260	1.8	10	4
	23	★	MHS0980L250B	227.2	251.8	251.8	311.8	310	1.8	10	4
	28	★	MHS0980L300B	276.2	301.8	301.8	361.8	360	1.8	10	4
9.9	2	□	MHS0990L040B	21.5	41.7	41.7	101.7	100	1.7	10	3
	7	□	MHS0990L090B	71.1	91.8	91.8	151.8	150	1.8	10	4
	10	□	MHS0990L120B	100.8	121.8	121.8	181.8	180	1.8	10	4
	13	□	MHS0990L150B	130.5	151.8	151.8	211.8	210	1.8	10	4
	18	□	MHS0990L200B	180.0	201.8	201.8	261.8	260	1.8	10	4
	23	□	MHS0990L250B	229.5	251.8	251.8	311.8	310	1.8	10	4
	28	□	MHS0990L300B	279.0	301.8	301.8	361.8	360	1.8	10	4
10.0	1	●	MHS1000L040B	11.7	41.7	41.7	101.7	100	1.7	10	3
	6	●	MHS1000L090B	61.8	91.8	91.8	151.8	150	1.8	10	4
	9	●	MHS1000L120B	91.8	121.8	121.8	181.8	180	1.8	10	4
	12	●	MHS1000L150B	121.8	151.8	151.8	211.8	210	1.8	10	4
	17	●	MHS1000L200B	171.8	201.8	201.8	261.8	260	1.8	10	4
	22	●	MHS1000L250B	221.8	251.8	251.8	311.8	310	1.8	10	4
	27	●	MHS1000L300B	271.8	301.8	301.8	361.8	360	1.8	10	4
10.1	1	□	MHS1010L040B	11.8	40.2	41.7	101.7	100	1.7	12	3
	6	□	MHS1010L090B	62.4	90.3	91.8	151.8	150	1.8	12	4
	9	□	MHS1010L120B	92.7	120.3	121.8	181.8	180	1.8	12	4
	12	□	MHS1010L150B	123.0	150.3	151.8	211.8	210	1.8	12	4
	17	□	MHS1010L200B	173.5	200.3	201.8	261.8	260	1.8	12	4
	22	□	MHS1010L250B	224.0	250.3	251.8	311.8	310	1.8	12	4
	27	□	MHS1010L300B	274.5	300.3	301.8	361.8	360	1.8	12	4

М
ИНСТРУМЕНТ ДЛЯ СВЕРЛЕНИЯ

DC (мм)	Глубина сверления (L/D)	VP15TF	Обозначение	Размеры (мм)								Тип
				LU	LCF	LH	OAL	LF	PL	DCON		
10.2	1	□	MHS1020L040B	12.0	40.3	41.8	101.8	100	1.8	12	3	
	6	□	MHS1020L090B	63.1	90.4	91.9	151.9	150	1.9	12	4	
	9	□	MHS1020L120B	93.7	120.4	121.9	181.9	180	1.9	12	4	
	12	□	MHS1020L150B	124.3	150.4	151.9	211.9	210	1.9	12	4	
	17	□	MHS1020L200B	175.3	200.4	201.9	261.9	260	1.9	12	4	
	22	□	MHS1020L250B	226.3	250.4	251.9	311.9	310	1.9	12	4	
	27	□	MHS1020L300B	277.3	300.4	301.9	361.9	360	1.9	12	4	
10.3	1	□	MHS1030L040B	12.1	40.3	41.8	101.8	100	1.8	12	3	
	6	□	MHS1030L090B	63.7	90.4	91.9	151.9	150	1.9	12	4	
	9	□	MHS1030L120B	94.6	120.4	121.9	181.9	180	1.9	12	4	
	12	□	MHS1030L150B	125.5	150.4	151.9	211.9	210	1.9	12	4	
	17	□	MHS1030L200B	177.0	200.4	201.9	261.9	260	1.9	12	4	
	22	□	MHS1030L250B	228.5	250.4	251.9	311.9	310	1.9	12	4	
	26	□	MHS1030L300B	269.7	300.4	301.9	361.9	360	1.9	12	4	
10.4	1	□	MHS1040L040B	12.2	40.3	41.8	101.8	100	1.8	12	3	
	6	□	MHS1040L090B	64.3	90.4	91.9	151.9	150	1.9	12	4	
	9	□	MHS1040L120B	95.5	120.4	121.9	181.9	180	1.9	12	4	
	12	□	MHS1040L150B	126.7	150.4	151.9	211.9	210	1.9	12	4	
	17	□	MHS1040L200B	178.7	200.4	201.9	261.9	260	1.9	12	4	
	21	□	MHS1040L250B	220.3	250.4	251.9	311.9	310	1.9	12	4	
	26	□	MHS1040L300B	272.3	300.4	301.9	361.9	360	1.9	12	4	
10.5	1	★	MHS1050L040B	12.3	40.3	41.8	101.8	100	1.8	12	3	
	6	★	MHS1050L090B	64.9	90.4	91.9	151.9	150	1.9	12	4	
	9	★	MHS1050L120B	96.4	120.4	121.9	181.9	180	1.9	12	4	
	12	★	MHS1050L150B	127.9	150.4	151.9	211.9	210	1.9	12	4	
	16	★	MHS1050L200B	169.9	200.4	201.9	261.9	260	1.9	12	4	
	21	★	MHS1050L250B	222.4	250.4	251.9	311.9	310	1.9	12	4	
	26	★	MHS1050L300B	274.9	300.4	301.9	361.9	360	1.9	12	4	
10.6	1	□	MHS1060L040B	12.4	40.8	41.8	101.8	100	1.8	12	3	
	6	□	MHS1060L090B	65.5	90.9	91.9	151.9	150	1.9	12	4	
	9	□	MHS1060L120B	97.3	120.9	121.9	181.9	180	1.9	12	4	
	12	□	MHS1060L150B	129.1	150.9	151.9	211.9	210	1.9	12	4	
	16	□	MHS1060L200B	171.5	200.9	201.9	261.9	260	1.9	12	4	
	21	□	MHS1060L250B	224.5	250.9	251.9	311.9	310	1.9	12	4	
	26	□	MHS1060L300B	277.5	300.9	301.9	361.9	360	1.9	12	4	
10.7	1	□	MHS1070L040B	12.5	40.8	41.8	101.8	100	1.8	12	3	
	6	□	MHS1070L090B	66.1	90.9	91.9	151.9	150	1.9	12	4	
	9	□	MHS1070L120B	98.2	120.9	121.9	181.9	180	1.9	12	4	
	11	□	MHS1070L150B	119.6	150.9	151.9	211.9	210	1.9	12	4	
	16	□	MHS1070L200B	173.1	200.9	201.9	261.9	260	1.9	12	4	
	21	□	MHS1070L250B	226.6	250.9	251.9	311.9	310	1.9	12	4	
	25	□	MHS1070L300B	269.4	300.9	301.9	361.9	360	1.9	12	4	
10.8	1	★	MHS1080L040B	12.7	40.9	41.9	101.9	100	1.9	12	3	
	6	★	MHS1080L090B	66.8	91.0	92.0	152.0	150	2.0	12	4	
	9	★	MHS1080L120B	99.2	121.0	122.0	182.0	180	2.0	12	4	
	11	★	MHS1080L150B	120.8	151.0	152.0	212.0	210	2.0	12	4	
	16	★	MHS1080L200B	174.8	201.0	202.0	262.0	260	2.0	12	4	
	21	★	MHS1080L250B	228.8	251.0	252.0	312.0	310	2.0	12	4	
	25	★	MHS1080L300B	272.0	301.0	302.0	362.0	360	2.0	12	4	

DC (мм)	Глубина сверления (L/D)	VP15TF	Обозначение	Размеры (мм)								Тип
				LU	LCF	LH	OAL	LF	PL	DCON		
10.9	1	□	MHS1090L040B	12.8	40.9	41.9	101.9	100	1.9	12	3	
	6	□	MHS1090L090B	67.4	91.0	92.0	152.0	150	2.0	12	4	
	8	□	MHS1090L120B	89.2	121.0	122.0	182.0	180	2.0	12	4	
	11	□	MHS1090L150B	121.9	151.0	152.0	212.0	210	2.0	12	4	
	16	□	MHS1090L200B	176.4	201.0	202.0	262.0	260	2.0	12	4	
	20	□	MHS1090L250B	220.0	251.0	252.0	312.0	310	2.0	12	4	
	25	□	MHS1090L300B	274.5	301.0	302.0	362.0	360	2.0	12	4	
11.0	1	●	MHS1100L040B	12.9	40.9	41.9	101.9	100	1.9	12	3	
	6	●	MHS1100L090B	68.0	91.0	92.0	152.0	150	2.0	12	4	
	8	●	MHS1100L120B	90.0	121.0	122.0	182.0	180	2.0	12	4	
	11	●	MHS1100L150B	123.0	151.0	152.0	212.0	210	2.0	12	4	
	16	●	MHS1100L200B	178.0	201.0	202.0	262.0	260	2.0	12	4	
	20	●	MHS1100L250B	222.0	251.0	252.0	312.0	310	2.0	12	4	
	25	●	MHS1100L300B	277.0	301.0	302.0	362.0	360	2.0	12	4	
11.1	1	□	MHS1110L040B	13.0	41.4	41.9	101.9	100	1.9	12	3	
	6	□	MHS1110L090B	68.6	91.5	92.0	152.0	150	2.0	12	4	
	8	□	MHS1110L120B	90.8	121.5	122.0	182.0	180	2.0	12	4	
	11	□	MHS1110L150B	124.1	151.5	152.0	212.0	210	2.0	12	4	
	15	□	MHS1110L200B	168.5	201.5	202.0	262.0	260	2.0	12	4	
	20	□	MHS1110L250B	224.0	251.5	252.0	312.0	310	2.0	12	4	
	24	□	MHS1110L300B	268.4	301.5	302.0	362.0	360	2.0	12	4	
11.2	1	□	MHS1120L040B	13.1	41.4	41.9	101.9	100	1.9	12	3	
	5	□	MHS1120L090B	58.0	91.5	92.0	152.0	150	2.0	12	4	
	8	□	MHS1120L120B	91.6	121.5	122.0	182.0	180	2.0	12	4	
	11	□	MHS1120L150B	125.2	151.5	152.0	212.0	210	2.0	12	4	
	15	□	MHS1120L200B	170.0	201.5	202.0	262.0	260	2.0	12	4	
	20	□	MHS1120L250B	226.0	251.5	252.0	312.0	310	2.0	12	4	
	24	□	MHS1120L300B	270.8	301.5	302.0	362.0	360	2.0	12	4	
11.3	1	□	MHS1130L040B	13.2	41.4	41.9	101.9	100	1.9	12	3	
	5	□	MHS1130L090B	58.6	91.6	92.1	152.1	150	2.1	12	4	
	8	□	MHS1130L120B	92.5	121.6	122.1	182.1	180	2.1	12	4	
	11	□	MHS1130L150B	126.4	151.6	152.1	212.1	210	2.1	12	4	
	15	□	MHS1130L200B	171.6	201.6	202.1	262.1	260	2.1	12	4	
	20	□	MHS1130L250B	228.1	251.6	252.1	312.1	310	2.1	12	4	
	24	□	MHS1130L300B	273.3	301.6	302.1	362.1	360	2.1	12	4	
11.4	1	□	MHS1140L040B	13.4	41.5	42.0	102.0	100	2.0	12	3	
	5	□	MHS1140L090B	59.1	91.6	92.1	152.1	150	2.1	12	4	
	8	□	MHS1140L120B	93.3	121.6	122.1	182.1	180	2.1	12	4	
	11	□	MHS1140L150B	127.5	151.6	152.1	212.1	210	2.1	12	4	
	15	□	MHS1140L200B	173.1	201.6	202.1	262.1	260	2.1	12	4	
	19	□	MHS1140L250B	218.7	251.6	252.1	312.1	310	2.1	12	4	
	24	□	MHS1140L300B	275.7	301.6	302.1	362.1	360	2.1	12	4	
11.5	1	★	MHS1150L040B	13.5	41.5	42.0	102.0	100	2.0	12	3	
	5	★	MHS1150L090B	59.6	91.6	92.1	152.1	150	2.1	12	4	
	8	★	MHS1150L120B	94.1	121.6	122.1	182.1	180	2.1	12	4	
	10	★	MHS1150L150B	117.1	151.6	152.1	212.1	210	2.1	12	4	
	15	★	MHS1150L200B	174.6	201.6	202.1	262.1	260	2.1	12	4	
	19	★	MHS1150L250B	220.6	251.6	252.1	312.1	310	2.1	12	4	
	24	★	MHS1150L300B	278.1	301.6	302.1	362.1	360	2.1	12	4	

Примечание 1) Пожалуйста, свяжитесь с нами если Вы не нашли нужную геометрию в данном каталоге (могут быть заказаны другие диаметры и длины).

● : Есть на складе. ★ : Со склада в Японии.

□ : Нет на складе, выпускается исключительно под заказ.

DC (мм)	Глубина сверления (LD)	VP15TF	Обозначение	Размеры (мм)							Тип
				LU	LCF	LH	OAL	LF	PL	DCON	
11.6	1	□	MHS1160L040B	13.6	42.0	42.0	102.0	100	2.0	12	3
	5	□	MHS1160L090B	60.1	92.1	92.1	152.1	150	2.1	12	4
	8	□	MHS1160L120B	94.9	122.1	122.1	182.1	180	2.1	12	4
	10	□	MHS1160L150B	118.1	152.1	152.1	212.1	210	2.1	12	4
	15	□	MHS1160L200B	176.1	202.1	202.1	262.1	260	2.1	12	4
	19	□	MHS1160L250B	222.5	252.1	252.1	312.1	310	2.1	12	4
	23	□	MHS1160L300B	268.9	302.1	302.1	362.1	360	2.1	12	4
11.7	1	□	MHS1170L040B	13.7	42.0	42.0	102.0	100	2.0	12	3
	5	□	MHS1170L090B	60.6	92.1	92.1	152.1	150	2.1	12	4
	8	□	MHS1170L120B	95.7	122.1	122.1	182.1	180	2.1	12	4
	10	□	MHS1170L150B	119.1	152.1	152.1	212.1	210	2.1	12	4
	15	□	MHS1170L200B	177.6	202.1	202.1	262.1	260	2.1	12	4
	19	□	MHS1170L250B	224.4	252.1	252.1	312.1	310	2.1	12	4
	23	□	MHS1170L300B	271.2	302.1	302.1	362.1	360	2.1	12	4
11.8	1	★	MHS1180L040B	13.8	42.0	42.0	102.0	100	2.0	12	3
	5	★	MHS1180L090B	61.1	92.1	92.1	152.1	150	2.1	12	4
	8	★	MHS1180L120B	96.5	122.1	122.1	182.1	180	2.1	12	4
	10	★	MHS1180L150B	120.1	152.1	152.1	212.1	210	2.1	12	4
	14	★	MHS1180L200B	167.3	202.1	202.1	262.1	260	2.1	12	4
	19	★	MHS1180L250B	226.3	252.1	252.1	312.1	310	2.1	12	4
	23	★	MHS1180L300B	273.5	302.1	302.1	362.1	360	2.1	12	4
11.9	1	□	MHS1190L040B	13.9	42.0	42.0	102.0	100	2.0	12	3
	5	□	MHS1190L090B	61.7	92.2	92.2	152.2	150	2.2	12	4
	8	□	MHS1190L120B	97.4	122.2	122.2	182.2	180	2.2	12	4
	10	□	MHS1190L150B	121.2	152.2	152.2	212.2	210	2.2	12	4
	14	□	MHS1190L200B	168.8	202.2	202.2	262.2	260	2.2	12	4
	19	□	MHS1190L250B	228.3	252.2	252.2	312.2	310	2.2	12	4
	23	□	MHS1190L300B	275.9	302.2	302.2	362.2	360	2.2	12	4
12.0	1	●	MHS1200L040B	14.1	42.1	42.1	102.1	100	2.1	12	3
	5	●	MHS1200L090B	62.2	92.2	92.2	152.2	150	2.2	12	4
	7	●	MHS1200L120B	86.2	122.2	122.2	182.2	180	2.2	12	4
	10	●	MHS1200L150B	122.2	152.2	152.2	212.2	210	2.2	12	4
	14	●	MHS1200L200B	170.2	202.2	202.2	262.2	260	2.2	12	4
	18	●	MHS1200L250B	218.2	252.2	252.2	312.2	310	2.2	12	4
	22	●	MHS1200L300B	266.2	302.2	302.2	362.2	360	2.2	12	4

ИНСТРУКЦИЯ ПО ЭКСПЛУАТАЦИИ

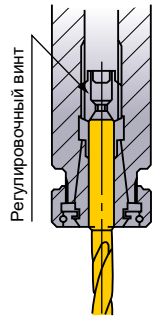
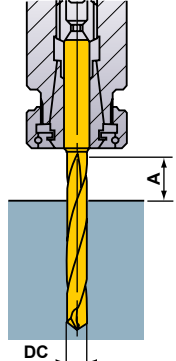
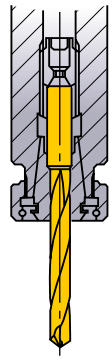
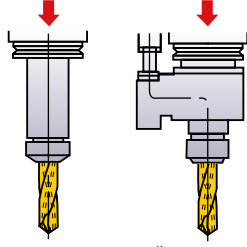
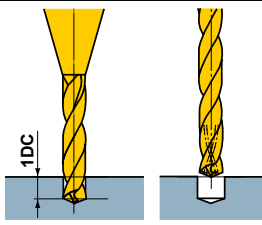
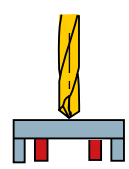
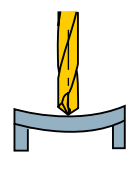
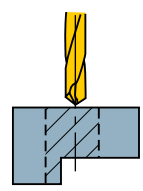
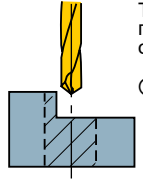
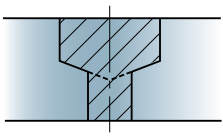
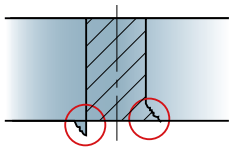
<h3>Крепление сверла</h3>  <p>Цанговый патрон с упорным подшипником надежно держит сверло.</p>	<h3>Длина сверла</h3>  <p>$A \geq DC \times 2$</p>	<h3>Установка сверла</h3>  <p>Не прижимать по режущей кромке.</p>	<h3>Тип охлаждения через сквозные отверстия</h3> <p>Тип охлаждения через шпиндель Тип охлаждения на вращающийся шпиндель станка</p>  <p>Давление охлаждающей среды должно составлять ок. 15 Бар – 70 Бар Рекомендованная Давление СОЖ: ≥ 30 Бар</p>
<h3>Установка сверла</h3>  <p>1) Выполните направляющее отверстие приблиз. 1DC (DC: диаметр сверла) при помощи MHS со сверлами, имеющими минимальную длину режущей кромки. 2) Используйте направляющее отверстие и выполните обработку сверлом с каналом для подвода СОЖ. В зависимости от применения выполняйте сверление с периодическим выводом сверла.</p>	<h3>Рекомендации по использованию СОЖ</h3> <ol style="list-style-type: none"> 1) Рекомендуется регулярно проводить замену СОЖ во избежание забивания каналов в сверле. 2) Для предотвращения забивания мелкой стружкой отверстий сверла используйте фильтр, как профилактическую меру. Для сверл малого диаметра рекомендуется применять фильтр с более мелкими отверстиями. 	<h3>Тонкая заготовка</h3>  <p>OK Необходима опора для заготовки.</p>  <p>X Если наблюдается отгиб.</p>	<h3>Прерывистое резание</h3>  <p>OK Один процесс ① Уменьшить подачу при сверлении ступенчатой детали (при прерывистом сверлении).</p>  <p>Требуется предварительная обработка. ① До сверления предварительно подрезать торец концевой фрезой.</p>
<h3>Ступенчатые отверстия.</h3>  <ol style="list-style-type: none"> ① Разделите операцию на два перехода. ② Сначала просверлите отверстие большего диаметра. <p>* Инструменты для снятия фаски и цекования могут быть изготовлены по заказу.</p>	<h3>Образование заусенцев и выкрашивание заготовки.</h3>  <ol style="list-style-type: none"> ① На выходе сверла из отверстия снизьте подачу. ② Измените угол при вершине. 		

■ РУКОВОДСТВО ПО ИСПОЛЬЗОВАНИЮ MHS (L/D ≥ 10)

СВЕРЛЕНИЕ НА ПЛОСКИХ ПОВЕРХНОСТЯХ ● Сделать глухое отверстие

■ 1. Выполнить направляющее отверстие



- ① Используйте сверло с большим двойным углом в плане, чем у сверла длинного исполнения. Используйте сверло с минимальной длиной режущей кромки.
- ② Для обеспечения высокой точности отверстия, точно выполняйте направляющее отверстие.
- ③ Глубина сверления: около 1DC или глубже.
(Выберите глубину направляющего отверстия, соответствующую длине сверхдлинного сверла.)

■ 2. Предварительная обработка при помощи длинного сверла



- ① Вводите сверло в направляющее отверстие при низких оборотах (вращение 1000 мин⁻¹, скорость подачи 0,2—0,3 мм/об).
- ② Остановить сверло для глубоких отверстий 0,5—1 мм до достижения дна направляющего отверстия.

■ 3. Сверление глубокого отверстия

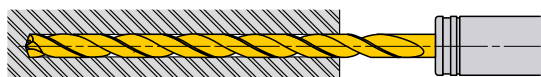

- ① Увеличьте частоту вращения и подачу за цикл и просверлите до желаемой глубины.

■ 4. Отвод сверла из отверстия



- ① После окончания сверления снизьте обороты, не доходя приблизительно 0,5—1 мм до конца отверстия (частота вращения около 1000 мин⁻¹).
- ② Выньте сверло примерно до глубины направляющего отверстия (Vf=3000мм/мин.)
- ③ Выведите сверло из направляющего отверстия с уменьшенной частотой вращения (n=300, Vf=3000мм/мин)

СВЕРЛЕНИЕ НА НАКЛОННЫХ ПОВЕРХНОСТЯХ ● Отверстия на изогнутых заготовках

■ 1. Фрезерование плоских поверхностей



- ① Отфрезеруйте плоскую поверхность на заготовке фрезой, такого же диаметра, что и диаметр желаемого отверстия.

■ 2. Выполнить направляющее отверстие



- ① Используйте сверло с большим двойным углом в плане, чем у сверла длинного исполнения. Используйте сверло с минимальной длиной режущей кромки.
- ② Для обеспечения высокой точности отверстия, точно выполняйте направляющее отверстие.
- ③ Глубина сверления: около 1DC или глубже.
(Выберите глубину направляющего отверстия, соответствующую длине сверхдлинного сверла.)

■ 3. Предварительная обработка при помощи длинного сверла



- ① Вводите сверло в направляющее отверстие на низких оборотах (частота вращения 1000 мин⁻¹, скорость подачи 0,2—0,3 мм/об).
- ② Остановить длинное сверло за 0,5—1 мм до достижения дна направляющего отверстия.

■ 4. Сверление глубокого отверстия

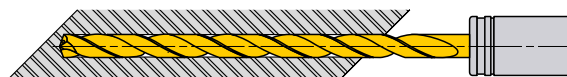

- ① Увеличьте частоту вращения и подачу за цикл и просверлите до желаемой глубины.

■ 5. Проходные отверстия

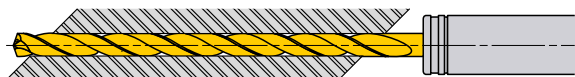

- ① При выходе из заготовки режущая кромка сверла может обломиться.
- ② При выводе сверла в отверстие снизьте скорость подачи.

■ 6. Отвод сверла из отверстия



- ① Обработайте отверстие со скоростью резания 20—30м/мин и подачей 0,2—0,3мм/об.
- ② Поднимите сверло из направляющего отверстия до глубины начальной точки с подачей 3000мм/мин.

ИНСТРУМЕНТ ДЛЯ СВЕРЛЕНИЯ (СВЕРЛА СО СМЕННЫМИ ПЛАСТИНАМИ)

STAW

- Волнистая режущая кромка спроектирована для улучшения контроля за стружкой.
- Очень жёсткая система зажима обеспечивает стабильность и надёжность при сверлении отверстий малого диаметра.



ТВЕРДЫЙ СПЛАВ

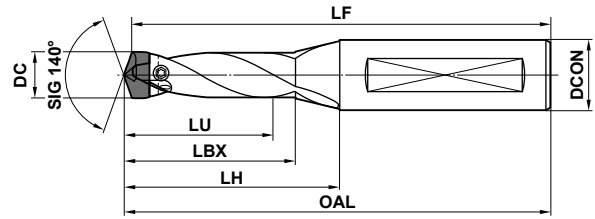

■ ДЕРЖАВКА

DC (мм)	Глубина сверления (LD)	Державка		Размеры (мм)						F Ключ	Пластина		
		Обозначение	Наличие	LU	LBX	LH	OAL	LF	DCON		DC (мм)	Обозначение	Наличие VP15TF
10.0 10.4	1.5	STAWSS1000S16	●	16.8	23.8	33.8	81.8	80	16	TIP06F	10.0	* STAWN1000TH STAWK1000TG	●
	3	STAWSN1000S16	●	31.8	38.8	48.8	96.8	95	16	TIP06F	10.1	STAWN1010TH STAWK1010TG	●
	5	STAWMN1000S16	●	51.8	58.8	68.8	116.8	115	16	TIP06F	10.2	STAWN1020TH STAWK1020TG	●
	8	STAWLN1000S16	●	81.8	88.8	98.8	146.8	145	16	TIP06F	10.3 10.4	STAWN1030TH STAWK1030TG STAWN1040TH STAWK1040TG	●
10.5 10.9	1.5	STAWSS1050S16	●	17.7	23.9	33.9	81.9	80	16	TIP06F	10.5	* STAWN1050TH STAWK1050TG	●
	3	STAWSN1050S16	●	33.4	38.9	48.9	96.9	95	16	TIP06F	10.6	STAWN1060TH STAWK1060TG	●
	5	STAWMN1050S16	●	54.4	58.9	68.9	116.9	115	16	TIP06F	10.7	STAWN1070TH STAWK1070TG	●
	8	STAWLN1050S16	●	85.9	88.9	98.9	146.9	145	16	TIP06F	10.8 10.9	STAWN1080TH STAWK1080TG STAWN1090TH STAWK1090TG	●
11.0 11.4	1.5	STAWSS1100S16	●	18.5	27.0	38.0	86.0	84	16	TIP06F	11.0	* STAWN1100TH STAWK1100TG	●
	3	STAWSN1100S16	●	35.0	43.0	54.0	102.0	100	16	TIP06F	11.1	STAWN1110TH STAWK1110TG	●
	5	STAWMN1100S16	●	57.0	68.0	79.0	127.0	125	16	TIP06F	11.2	STAWN1120TH STAWK1120TG	●
	8	STAWLN1100S16	●	90.0	98.0	109.0	157.0	155	16	TIP06F	11.3 11.4	STAWN1130TH STAWK1130TG STAWN1140TH STAWK1140TG	●
11.5 11.9	1.5	STAWSS1150S16	●	19.4	27.1	38.1	86.1	84	16	TIP06F	11.5	* STAWN1150TH STAWK1150TG	●
	3	STAWSN1150S16	●	36.6	43.1	54.1	102.1	100	16	TIP06F	11.6	STAWN1160TH STAWK1160TG	●
	5	STAWMN1150S16	●	59.6	68.1	79.1	127.1	125	16	TIP06F	11.7	STAWN1170TH STAWK1170TG	●
	8	STAWLN1150S16	●	94.1	98.1	109.1	157.1	155	16	TIP06F	11.8 11.9	STAWN1180TH STAWK1180TG STAWN1190TH STAWK1190TG	●
12.0 12.4	1.5	STAWSS1200S16	●	20.2	29.2	41.2	89.2	87	16	TIP06F	12.0	* STAWN1200TH STAWK1200TG	●
	3	STAWSN1200S16	●	38.2	47.2	59.2	107.2	105	16	TIP06F	12.1	STAWN1210TH STAWK1210TG	●
	5	STAWMN1200S16	●	62.2	72.2	84.2	132.2	130	16	TIP06F	12.2	STAWN1220TH STAWK1220TG	●
	8	STAWLN1200S16	●	98.2	107.2	119.2	167.2	165	16	TIP06F	12.3 12.4	STAWN1230TH STAWK1230TG STAWN1240TH STAWK1240TG	●

Примечание: 1) Приведенные выше размеры (*) указаны для установки пластин.

Примечание 2) Пожалуйста, свяжитесь с нами если Вы не нашли нужную геометрию в данном каталоге (могут быть заказаны другие диаметры и длины).

● : Есть на складе.

(Примечание : 1 пластина в наборе)

ОПИСАНИЕ ПЛАСТИН > M144
РЕЖИМЫ РЕЗАНИЯ > M146
РЕКОМЕНДАЦИИ > M147

ЗАПАСНЫЕ ЧАСТИ > N001
ТЕХНИЧЕСКИЕ ДАННЫЕ > P001

M141

ИНСТРУМЕНТ ДЛЯ СВЕРЛЕНИЯ

M

STAW

ТВЕРДЫЙ
СПЛАВ

М
ИНСТРУМЕНТ ДЛЯ
СВЕРЛЕНИЯ

DC (мм)	Глубина сверления (L/D)	Державка		Размеры (мм)						F W Ключ	Пластина		
		Обозначение	Наличие	LU	LBX	LF	OAL	LF	DCON		DC (мм)	Обозначение	Наличие VP15TF
12.5 12.9	1.5	STAWSS1250S16	●	21.1	29.3	41.3	89.3	87	16	TIP06F	12.5	* STAWN1250TH STAWK1250TG	●
	3	STAWSN1250S16	●	39.8	47.3	59.3	107.3	105	16	TIP06F	12.6	STAWN1260TH STAWK1260TG	●
	5	STAWMN1250S16	●	64.8	72.3	84.3	132.3	130	16	TIP06F	12.7	STAWN1270TH STAWK1270TG	●
	8	STAWLN1250S16	●	102.3	107.3	119.3	167.3	165	16	TIP06F	12.8 12.9	STAWN1280TH STAWK1280TG STAWN1290TH STAWK1290TG	●
13.0 13.4	1.5	STAWSS1300S16	●	21.9	32.4	45.4	93.4	91	16	TIP08W	13.0	* STAWN1300TH STAWK1300TG	●
	3	STAWSN1300S16	●	41.4	51.4	64.4	112.4	110	16	TIP08W	13.1	STAWN1310TH STAWK1310TG	●
	5	STAWMN1300S16	●	67.4	76.4	89.4	137.4	135	16	TIP08W	13.2	STAWN1320TH STAWK1320TG	●
	8	STAWLN1300S16	●	106.4	116.4	129.4	177.4	175	16	TIP08W	13.3 13.4	STAWN1330TH STAWK1330TG STAWN1340TH STAWK1340TG	●
13.5 13.9	1.5	STAWSS1350S16	●	22.8	32.5	45.5	93.5	91	16	TIP08W	13.5	* STAWN1350TH STAWK1350TG	●
	3	STAWSN1350S16	●	43.0	51.5	64.5	112.5	110	16	TIP08W	13.6	STAWN1360TH STAWK1360TG	●
	5	STAWMN1350S16	●	70.0	76.5	89.5	137.5	135	16	TIP08W	13.7	STAWN1370TH STAWK1370TG	●
	8	STAWLN1350S16	●	110.5	116.5	129.5	177.5	175	16	TIP08W	13.8 13.9	STAWN1380TH STAWK1380TG STAWN1390TH STAWK1390TG	●
14.0 14.4	1.5	STAWSS1400S16	●	23.5	33.5	47.5	95.5	93	16	TIP08W	14.0	* STAWN1400TH STAWK1400TG	●
	3	STAWSN1400S16	●	44.5	55.5	69.5	117.5	115	16	TIP08W	14.1	STAWN1410TH STAWK1410TG	●
	5	STAWMN1400S16	●	72.5	85.5	99.5	147.5	145	16	TIP08W	14.2	STAWN1420TH STAWK1420TG	●
	8	STAWLN1400S16	●	114.5	124.5	139.5	187.5	185	16	TIP08W	14.3 14.4	STAWN1430TH STAWK1430TG STAWN1440TH STAWK1440TG	●
14.5 14.9	1.5	STAWSS1450S16	●	24.4	33.6	47.6	95.6	93	16	TIP08W	14.5	* STAWN1450TH STAWK1450TG	●
	3	STAWSN1450S16	●	46.1	55.6	69.6	117.6	115	16	TIP08W	14.6	STAWN1460TH STAWK1460TG	●
	5	STAWMN1450S16	●	75.1	85.6	99.6	147.6	145	16	TIP08W	14.7	STAWN1470TH STAWK1470TG	●
	8	STAWLN1450S16	●	118.6	124.6	139.6	187.6	185	16	TIP08W	14.8 14.9	STAWN1480TH STAWK1480TG STAWN1490TH STAWK1490TG	●
15.0 15.4	1.5	STAWSS1500S20	●	25.2	35.7	50.7	100.7	98	20	TIP08W	15.0	* STAWN1500TH STAWK1500TG	●
	3	STAWSN1500S20	●	47.7	62.7	77.7	127.7	125	20	TIP08W	15.1	STAWN1510TH STAWK1510TG	●
	5	STAWMN1500S20	●	77.7	92.7	107.7	157.7	155	20	TIP08W	15.2	STAWN1520TH STAWK1520TG	●
	8	STAWLN1500S20	●	122.7	132.7	150.7	200.7	198	20	TIP08W	15.3 15.4	STAWN1530TH STAWK1530TG STAWN1540TH STAWK1540TG	●

Примечание 1) Приведенные выше размеры (*) указаны для установки пластин.

Примечание 2) Пожалуйста, свяжитесь с нами если Вы не нашли нужную геометрию в данном каталоге (могут быть заказаны другие диаметры и длины).

● : Есть на складе. (Примечание : 1 пластина в наборе)

ПЛАСТИНЫ

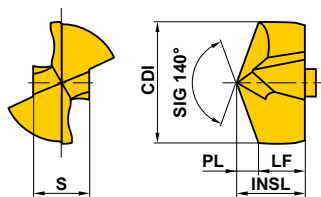

Обозначение	С покрытием		Размеры (мм)					Применяемый корпус
	VP15TF		CDI	INSL	LF	PL	S	
STAWN1000TH	●		10.0	5.6	3.8	1.8	4.6	STAWSS1000S16 STAWSN1000S16 STAWMN1000S16 STAWLN1000S16
STAWN1010TH	●		10.1	5.6	3.8	1.8	4.6	
STAWN1020TH	●		10.2	5.7	3.8	1.9	4.6	
STAWN1030TH	●		10.3	5.7	3.8	1.9	4.6	
STAWN1040TH	●		10.4	5.7	3.8	1.9	4.6	
STAWN1050TH	●		10.5	5.9	4.0	1.9	4.8	STAWSS1050S16 STAWSN1050S16 STAWMN1050S16 STAWLN1050S16
STAWN1060TH	●		10.6	5.9	4.0	1.9	4.8	
STAWN1070TH	●		10.7	5.9	4.0	1.9	4.8	
STAWN1080TH	●		10.8	6.0	4.0	2.0	4.8	
STAWN1090TH	●		10.9	6.0	4.0	2.0	4.8	
STAWN1100TH	●		11.0	6.2	4.2	2.0	5.1	STAWSS1100S16 STAWSN1100S16 STAWMN1100S16 STAWLN1100S16
STAWN1110TH	●		11.1	6.2	4.2	2.0	5.1	
STAWN1120TH	●		11.2	6.2	4.2	2.0	5.1	
STAWN1130TH	●		11.3	6.3	4.2	2.1	5.1	
STAWN1140TH	●		11.4	6.3	4.2	2.1	5.1	
STAWN1150TH	●		11.5	6.5	4.4	2.1	5.3	STAWSS1150S16 STAWSN1150S16 STAWMN1150S16 STAWLN1150S16
STAWN1160TH	●		11.6	6.5	4.4	2.1	5.3	
STAWN1170TH	●		11.7	6.5	4.4	2.1	5.3	
STAWN1180TH	●		11.8	6.5	4.4	2.1	5.3	
STAWN1190TH	●		11.9	6.6	4.4	2.2	5.3	
STAWN1200TH	●		12.0	6.8	4.6	2.2	5.5	STAWSS1200S16 STAWSN1200S16 STAWMN1200S16 STAWLN1200S16
STAWN1210TH	●		12.1	6.8	4.6	2.2	5.5	
STAWN1220TH	●		12.2	6.8	4.6	2.2	5.5	
STAWN1230TH	●		12.3	6.8	4.6	2.2	5.5	
STAWN1240TH	●		12.4	6.9	4.6	2.3	5.5	
STAWN1250TH	●		12.5	7.1	4.8	2.3	5.8	STAWSS1250S16 STAWSN1250S16 STAWMN1250S16 STAWLN1250S16
STAWN1260TH	●		12.6	7.1	4.8	2.3	5.8	
STAWN1270TH	●		12.7	7.1	4.8	2.3	5.8	
STAWN1280TH	●		12.8	7.1	4.8	2.3	5.8	
STAWN1290TH	●		12.9	7.1	4.8	2.3	5.8	
STAWN1300TH	●		13.0	7.3	4.9	2.4	6.0	STAWSS1300S16 STAWSN1300S16 STAWMN1300S16 STAWLN1300S16
STAWN1310TH	●		13.1	7.3	4.9	2.4	6.0	
STAWN1320TH	●		13.2	7.3	4.9	2.4	6.0	
STAWN1330TH	●		13.3	7.3	4.9	2.4	6.0	
STAWN1340TH	●		13.4	7.3	4.9	2.4	6.0	
STAWN1350TH	●		13.5	7.6	5.1	2.5	6.2	STAWSS1350S16 STAWSN1350S16 STAWMN1350S16 STAWLN1350S16
STAWN1360TH	●		13.6	7.6	5.1	2.5	6.2	
STAWN1370TH	●		13.7	7.6	5.1	2.5	6.2	
STAWN1380TH	●		13.8	7.6	5.1	2.5	6.2	
STAWN1390TH	●		13.9	7.6	5.1	2.5	6.2	

● : Есть на складе. (Примечание : 1 пластина в наборе)

Обозначение	С покрытием		Размеры (мм)					Применяемый корпус
	VP15TF		CDI	INSL	LF	PL	S	
STAWN1400TH	●		14.0	7.8	5.3	2.5	6.4	STAWSS1400S16 STAWSN1400S16 STAWMN1400S16 STAWLN1400S16
STAWN1410TH	●		14.1	7.9	5.3	2.6	6.4	
STAWN1420TH	●		14.2	7.9	5.3	2.6	6.4	
STAWN1430TH	●		14.3	7.9	5.3	2.6	6.4	
STAWN1440TH	●		14.4	7.9	5.3	2.6	6.4	
STAWN1450TH	●		14.5	8.1	5.5	2.6	6.7	STAWSS1450S16 STAWSN1450S16 STAWMN1450S16 STAWLN1450S16
STAWN1460TH	●		14.6	8.2	5.5	2.7	6.7	
STAWN1470TH	●		14.7	8.2	5.5	2.7	6.7	
STAWN1480TH	●		14.8	8.2	5.5	2.7	6.7	
STAWN1490TH	●		14.9	8.2	5.5	2.7	6.7	
STAWN1500TH	●		15.0	8.4	5.7	2.7	6.9	STAWSS1500S20 STAWSN1500S20 STAWMN1500S20 STAWLN1500S20
STAWN1510TH	●		15.1	8.4	5.7	2.7	6.9	
STAWN1520TH	●		15.2	8.5	5.7	2.8	6.9	
STAWN1530TH	●		15.3	8.5	5.7	2.8	6.9	
STAWN1540TH	●		15.4	8.5	5.7	2.8	6.9	
STAWN1550T	●		15.5	8.7	5.9	2.8	7.1	STAWSS1600S20 STAWSN1600S20 STAWMN1600S20 STAWLN1600S20
STAWN1560T	●		15.6	8.7	5.9	2.8	7.1	
STAWN1570T	●		15.7	8.8	5.9	2.9	7.1	
STAWN1580T	●		15.8	8.8	5.9	2.9	7.1	
STAWN1590T	●		15.9	8.8	5.9	2.9	7.1	
STAWN1600T	●		16.0	8.8	5.9	2.9	7.1	
STAWN1610T	●		16.1	8.8	5.9	2.9	7.1	
STAWN1620T	●		16.2	8.8	5.9	2.9	7.1	
STAWN1630T	●		16.3	8.9	5.9	3.0	7.1	
STAWN1640T	●		16.4	8.9	5.9	3.0	7.1	
STAWN1650T	●		16.5	9.3	6.3	3.0	7.6	STAWSS1700S20 STAWSN1700S20 STAWMN1700S20 STAWLN1700S20
STAWN1660T	●		16.6	9.3	6.3	3.0	7.6	
STAWN1670T	●		16.7	9.3	6.3	3.0	7.6	
STAWN1680T	●		16.8	9.4	6.3	3.1	7.6	
STAWN1690T	●		16.9	9.4	6.3	3.1	7.6	
STAWN1700T	●		17.0	9.4	6.3	3.1	7.6	
STAWN1710T	●		17.1	9.4	6.3	3.1	7.6	
STAWN1720T	●		17.2	9.4	6.3	3.1	7.6	
STAWN1730T	●		17.3	9.4	6.3	3.1	7.6	
STAWN1740T	●		17.4	9.5	6.3	3.2	7.6	
STAWN1750T	●		17.5	9.9	6.7	3.2	8.1	STAWSS1800S20 STAWSN1800S20 STAWMN1800S20 STAWLN1800S20
STAWN1760T	●		17.6	9.9	6.7	3.2	8.1	
STAWN1770T	●		17.7	9.9	6.7	3.2	8.1	
STAWN1780T	●		17.8	9.9	6.7	3.2	8.1	
STAWN1790T	●		17.9	10.0	6.7	3.3	8.1	
STAWN1800T	●		18.0	10.0	6.7	3.3	8.1	STAWSS1800S20 STAWSN1800S20 STAWMN1800S20 STAWLN1800S20
STAWN1810T	●		18.1	10.0	6.7	3.3	8.1	
STAWN1820T	●		18.2	10.0	6.7	3.3	8.1	
STAWN1830T	●		18.3	10.0	6.7	3.3	8.1	
STAWN1840T	●		18.4	10.0	6.7	3.3	8.1	

STAW

ШИРИНА ХОНИНГОВАНИЯ

Если требуется нестандартная пластина, а пластина с хонингованием, используйте для заказа нижеприведенные обозначения-символы.

(Стандарт хонингования)

(Номер заказа пластины)

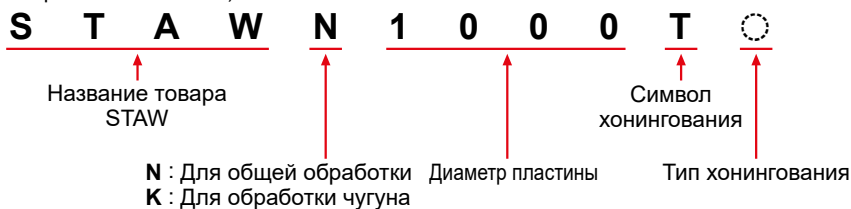

Тип хонингования	Ширина хонингования (мм)
F	0
G	0.02—0.05
H	0.05—0.10
- (Стандарт)	0.10—0.15
K	0.15—0.20
S	0.20—0.25
M	0.25—0.30

РЕКОМЕНДУЕМЫЕ РЕЖИМЫ РЕЗАНИЯ

Обрабатываемый материал	Диаметр сверла Условия Твердость	φ10.0—φ12.9		φ13.0—φ13.9		φ14.0—φ15.4		φ15.5—φ18.4	
		Скорость резания (м/мин)	Подача (мм/об)	Скорость резания (м/мин)	Подача (мм/об)	Скорость резания (м/мин)	Подача (мм/об)	Скорость резания (м/мин)	Подача (мм/об)
P Малоуглеродистые стали Углеродистая сталь Легированная сталь	≤180НВ	80 (60—100)	0.20 (0.15—0.25)	90 (70—110)	0.25 (0.20—0.30)	100 (80—120)	0.30 (0.25—0.35)	100 (80—120)	0.35 (0.25—0.40)
	180—280НВ	80 (60—100)	0.20 (0.15—0.25)	90 (70—110)	0.25 (0.20—0.30)	100 (80—120)	0.30 (0.25—0.35)	100 (80—120)	0.35 (0.25—0.40)
	280—350НВ	70 (60—90)	0.20 (0.15—0.25)	80 (60—100)	0.25 (0.20—0.30)	90 (70—110)	0.25 (0.20—0.30)	90 (70—110)	0.30 (0.20—0.35)
M Нержавеющая сталь	≤200НВ	40 (30—50)	0.13 (0.10—0.16)	50 (40—60)	0.15 (0.12—0.18)	60 (50—70)	0.17 (0.14—0.20)	60 (50—70)	0.17 (0.14—0.20)
K Чугун Ковкий чугун	Предел прочности ≤350МПа	80 (60—100)	0.20 (0.15—0.25)	90 (70—110)	0.25 (0.20—0.30)	100 (80—120)	0.30 (0.25—0.35)	120 (80—140)	0.45 (0.35—0.55)
	Предел прочности ≤450МПа	70 (60—90)	0.20 (0.15—0.25)	80 (60—100)	0.25 (0.20—0.30)	90 (70—110)	0.30 (0.25—0.35)	100 (80—120)	0.35 (0.25—0.40)

Примечание: 1) При использовании сверл для отверстий глубиной DCx1,5 можно увеличивать подачу приблизительно на 20 %.

Примечание: 2) При использовании корпуса типа DCx8 уменьшите скорость резания приблизительно на 20 %.

Примечание: 3) При использовании корпуса типа DCx8 рекомендуется применять пилотное отверстие.

Примечание: 4) Для нержавеющей стали используйте внутреннюю подачу СОЖ

(обработка с масляным туманом и минимальным количеством смазки не рекомендуется).

M

ИНСТРУМЕНТ ДЛЯ СВЕРЛЕНИЯ

ПРИМЕЧАНИЯ К ЭКСПЛУАТАЦИИ

■ УСТАНОВКА ПЛАСТИНЫ

- Прежде чем установить сменную пластину в корпус сверла, убедитесь, что отсутствует грязь и посторонние предметы. При необходимости прочистите корпус сверла сжатым воздухом.
- Воспользуйтесь приложенным ключом, чтобы немного отвернуть внутренний винт и ослабить крепление. Затем вставьте сменную пластину в паз корпуса сверла, как показано на рис. 1.
*Следите за тем, чтобы ключ при затягивании имел плотный контакт с головкой винта.
- После того как вы установите пластину, затяните внутренний винт и одновременно вдавите пластину в гнездо, как показано на рисунке 2, чтобы она заняла правильное положение и была надежно зафиксирована.
*Следите за тем, чтобы ключ при затягивании имел плотный контакт с головкой винта.

Затяните прижимной винт указанным ниже моментом.

Диам. сверла (мм)	Крутящий момент	
	N•м	
10 – 12.9	1	
13 – 15.4	2	
15.5 – 18.4	2.5	

- Убедитесь в том, что между пластиной и корпусом нет зазора.

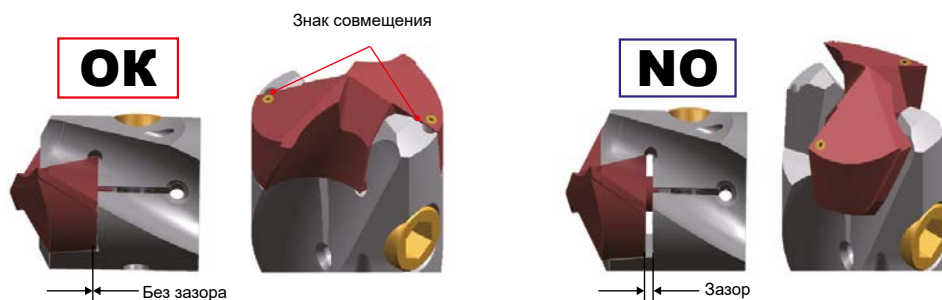
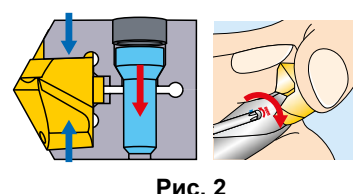
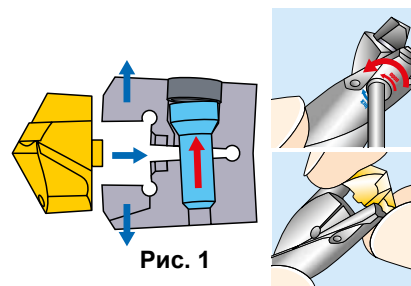
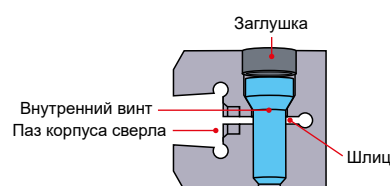

- Примечание 1) Если внутренний винт недостаточно затянут и пластина установлена неправильно, возможно снижение производительности сверления и/или поломка сверла. Поэтому при установке пластины следите за тем, чтобы знаки совмещения на корпусе и на пластине совпадали. При выполнении работы пользуйтесь средствами защиты.

ЗАПАСНЫЕ ЧАСТИ

Применяемый корпус	Обозначение комплекта (Внутренний винт и заглушка)		
		Внутренний винт	Заглушка
STAWSS/SN/MN/LN1000S16	WS203107TPS-35LH	WS203107TPS	WS35LH
STAWSS/SN/MN/LN1050S16	WS203107TPS-35LH	WS203107TPS	WS35LH
STAWSS/SN/MN/LN1100S16	WS203108TPS-35LH	WS203108TPS	WS35LH
STAWSS/SN/MN/LN1150S16	WS203108TPS-35LH	WS203108TPS	WS35LH
STAWSS/SN/MN/LN1200S16	WS203108TPS-35LH	WS203108TPS	WS35LH
STAWSS/SN/MN/LN1250S16	WS203108TPS-35LH	WS203108TPS	WS35LH
STAWSS/SN/MN/LN1300S16	WS253909TPS-45LH	WS253909TPS	WS45LH
STAWSS/SN/MN/LN1350S16	WS253909TPS-45LH	WS253909TPS	WS45LH
STAWSS/SN/MN/LN1400S16	WS253909TPS-45LH	WS253909TPS	WS45LH
STAWSS/SN/MN/LN1450S16	WS253909TPS-45LH	WS253909TPS	WS45LH
STAWSS/SN/MN/LN1500S20	WS253909TPS-45LH	WS253909TPS	WS45LH
STAWSS/SN/MN/LN1600S20	WS304912TPS-55LH	WS304912TPS	WS55LH
STAWSS/SN/MN/LN1700S20	WS304912TPS-55LH	WS304912TPS	WS55LH
STAWSS/SN/MN/LN1800S20	WS304912TPS-55LH	WS304912TPS	WS55LH

Примечание 1) Запасные части комплектуются внутренним винтом, стопорным винтом и руководством по эксплуатации. Пожалуйста, замените все части согласно приложенной инструкции.

ИНСТРУМЕНТ ДЛЯ СВЕРЛЕНИЯ (СВЕРЛА СО СМЕННЫМИ ПЛАСТИНАМИ)

ТВЕРДЫЙ СПЛАВ

TAW

- Волнистая режущая кромка спроектирована для улучшения контроля за стружкой.
- Специальные рифления для точной установки пластины.
- Легкая замена пластины.



Для общей обработки

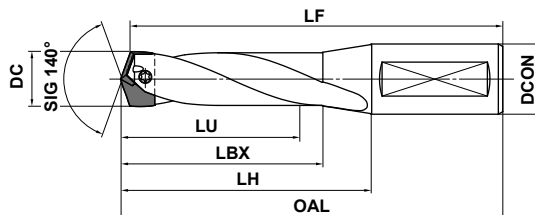

M

ИНСТРУМЕНТ ДЛЯ СВЕРЛЕНИЯ

■ ДЕРЖАВКА

DC (мм)	Глубина сверления (L/D)	Державка		Размеры (мм)						Крепёжный винт	Ключ	Очиститель	Смазка	Пластина			
		Обозначение	Наличие	LU	LBX	LH	OAL	LF	DCON					DC (мм)	Обозначение	Наличие	
														VP15TF	VP10H		
18.5 19.4	3	TAWSN1900S25	●	58.9	71.4	102.4	158.4	155.0	25	WS304517T	TKY10T	WPT4405	MK1KS	18.5	* TAWNH1850T	●	<input type="checkbox"/>
															TAWKH1850TG		
														18.6	TAWNH1860T	●	<input type="checkbox"/>
															TAWKH1860TG		
		18.7	TAWNH1870T	●	<input type="checkbox"/>												
			TAWKH1870TG														
		18.8	TAWNH1880T	●	<input type="checkbox"/>												
			TAWKH1880TG														
		18.9	TAWNH1890T	●	<input type="checkbox"/>												
			TAWKH1890TG														
		19.0	TAWNH1900T	●	<input type="checkbox"/>												
			TAWKH1900TG														
	19.1	TAWNH1910T	●	<input type="checkbox"/>													
		TAWKH1910TG															
	19.2	TAWNH1920T	●	<input type="checkbox"/>													
		TAWKH1920TG															
	19.3	TAWNH1930T	●	<input type="checkbox"/>													
		TAWKH1930TG															
	19.4	TAWNH1940T	●	<input type="checkbox"/>													
		TAWKH1940TG															
19.5 20.4	3	TAWSN2000S25	●	62.0	75.5	102.5	158.5	155.0	25	WS304518T	TKY10T	WPT4405	MK1KS	19.5	* TAWNH1950T	●	<input type="checkbox"/>
															TAWKH1950TG		
														19.6	TAWNH1960T	●	<input type="checkbox"/>
															TAWKH1960TG		
		19.7	TAWNH1970T	●	<input type="checkbox"/>												
			TAWKH1970TG														
		19.8	TAWNH1980T	●	<input type="checkbox"/>												
			TAWKH1980TG														
		19.9	TAWNH1990T	●	<input type="checkbox"/>												
			TAWKH1990TG														
		20.0	TAWNH2000T	●	<input type="checkbox"/>												
			TAWKH2000TG														
	20.1	TAWNH2010T	<input type="checkbox"/>	<input type="checkbox"/>													
		TAWKH2010TG															
	20.2	TAWNH2020T	<input type="checkbox"/>	<input type="checkbox"/>													
		TAWKH2020TG															
	20.3	TAWNH2030T	<input type="checkbox"/>	<input type="checkbox"/>													
		TAWKH2030TG															
	20.4	TAWNH2040T	<input type="checkbox"/>	<input type="checkbox"/>													
		TAWKH2040TG															

Примечание 1) Приведенные выше размеры (*) указаны для случая установленных на корпусе пластин.

Примечание 2) Пожалуйста, свяжитесь с нами если Вы не нашли нужную геометрию в данном каталоге (могут быть заказаны другие диаметры и длины).

● : Есть на складе. : Нет на складе, выпускается исключительно под заказ.
(Примечание : 1 пластина в наборе)

DC (мм)	Глубина сверления (L/D)	Державка		Размеры (мм)										Пластина			
		Обозначение	Наличие	LU	LBX	LH	OAL	LF	DCON					DC (мм)	Обозначение	Наличие	
																VP15TF	VP10H
20.5 21.4	3	TAWSN2100S25	●	65.2	78.7	102.7	158.7	155.0	25	WS304518T	TKY10T	WPT4405	МК1КС	20.5	* TAWNH2050T	●	<input type="checkbox"/>
															TAWKH2050TG		
														20.6	TAWNH2060T	<input type="checkbox"/>	<input type="checkbox"/>
															TAWKH2060TG		
		20.7	TAWNH2070T	<input type="checkbox"/>	<input type="checkbox"/>												
			TAWKH2070TG														
		20.8	TAWNH2080T	<input type="checkbox"/>	<input type="checkbox"/>												
			TAWKH2080TG														
		20.9	TAWNH2090T	<input type="checkbox"/>	<input type="checkbox"/>												
			TAWKH2090TG														
		21.0	TAWNH2100T	●	<input type="checkbox"/>												
			TAWKH2100TG														
	21.1	TAWNH2110T	<input type="checkbox"/>	<input type="checkbox"/>													
		TAWKH2110TG															
	21.2	TAWNH2120T	<input type="checkbox"/>	<input type="checkbox"/>													
		TAWKH2120TG															
	21.3	TAWNH2130T	<input type="checkbox"/>	<input type="checkbox"/>													
		TAWKH2130TG															
	21.4	TAWNH2140T	<input type="checkbox"/>	<input type="checkbox"/>													
		TAWKH2140TG															
21.5 22.4	3	TAWSN2200S25	●	68.4	83.2	108.2	164.2	160.3	25	WS355520T	TKY15T	WPT4405	МК1КС	21.5	* TAWNH2150T	●	<input type="checkbox"/>
															TAWKH2150TG		
														21.6	TAWNH2160T	<input type="checkbox"/>	<input type="checkbox"/>
															TAWKH2160TG		
		21.7	TAWNH2170T	<input type="checkbox"/>	<input type="checkbox"/>												
			TAWKH2170TG														
		21.8	TAWNH2180T	<input type="checkbox"/>	<input type="checkbox"/>												
			TAWKH2180TG														
		21.9	TAWNH2190T	<input type="checkbox"/>	<input type="checkbox"/>												
			TAWKH2190TG														
		22.0	TAWNH2200T	●	<input type="checkbox"/>												
			TAWKH2200TG														
	22.1	TAWNH2210T	<input type="checkbox"/>	<input type="checkbox"/>													
		TAWKH2210TG															
	22.2	TAWNH2220T	<input type="checkbox"/>	<input type="checkbox"/>													
		TAWKH2220TG															
	22.3	TAWNH2230T	<input type="checkbox"/>	<input type="checkbox"/>													
		TAWKH2230TG															
	22.4	TAWNH2240T	<input type="checkbox"/>	<input type="checkbox"/>													
		TAWKH2240TG															
22.5 23.4	3	TAWSN2300S25	●	71.6	86.4	108.4	164.4	160.3	25	WS355521T	TKY15T	WPT4405	МК1КС	22.5	* TAWNH2250T	●	<input type="checkbox"/>
															TAWKH2250TG		
														22.6	TAWNH2260T	<input type="checkbox"/>	<input type="checkbox"/>
															TAWKH2260TG		
		22.7	TAWNH2270T	<input type="checkbox"/>	<input type="checkbox"/>												
			TAWKH2270TG														
		22.8	TAWNH2280T	<input type="checkbox"/>	<input type="checkbox"/>												
			TAWKH2280TG														
		22.9	TAWNH2290T	<input type="checkbox"/>	<input type="checkbox"/>												
			TAWKH2290TG														
		23.0	TAWNH2300T	●	<input type="checkbox"/>												
			TAWKH2300TG														
	23.1	TAWNH2310T	<input type="checkbox"/>	<input type="checkbox"/>													
		TAWKH2310TG															
	23.2	TAWNH2320T	<input type="checkbox"/>	<input type="checkbox"/>													
		TAWKH2320TG															
	23.3	TAWNH2330T	<input type="checkbox"/>	<input type="checkbox"/>													
		TAWKH2330TG															
	23.4	TAWNH2340T	<input type="checkbox"/>	<input type="checkbox"/>													
		TAWKH2340TG															

M

ИНСТРУМЕНТ ДЛЯ
СВЕРЛЕНИЯ

ОПИСАНИЕ ПЛАСТИН > M155
РЕЖИМЫ РЕЗАНИЯ > M157
РЕКОМЕНДАЦИИ > M158

ЗАПАСНЫЕ ЧАСТИ > N001
ТЕХНИЧЕСКИЕ ДАННЫЕ > P001

M151

ИНСТРУМЕНТ ДЛЯ СВЕРЛЕНИЯ (СВЕРЛА СО СМЕННЫМИ ПЛАСТИНАМИ)

ТВЕРДЫЙ
СПЛАВ

TAW

М
ИНСТРУМЕНТ ДЛЯ
СВЕРЛЕНИЯ

DC (мм)	Глубина сверления (L/D)	Державка		Размеры (мм)						Крепёжный винт	Ключ	Очиститель	Смазка	Пластина																
		Обозначение	Наличие	LU	LBX	LH	OAL	LF	DCON					DC (мм)	Обозначение	Наличие														
														VP15TF	VP10H															
23.5 24.4	3	TAWSN2400S32	●	74.8	90.6	114.6	174.6	170.3	32	WS355521T	TKY15T	WPT4405	MK1KS	23.5	* TAWNH2350T	●	<input type="checkbox"/>													
															TAWKH2350TG															
														23.6	TAWNH2360T	<input type="checkbox"/>	<input type="checkbox"/>													
															TAWKH2360TG															
		5	TAWMN2400S32	●	121.8	139.6	164.6	224.6	220.3	32	WS355521T	TKY15T	WPT4405	MK1KS	23.7	TAWNH2370T	<input type="checkbox"/>	<input type="checkbox"/>												
															TAWKH2370TG															
		8	TAWLN2400S32	●	192.3	206.6	236.6	296.6	292.3	32	WS355521T	TKY15T	WPT4405	MK1KS	23.8	TAWNH2380T	<input type="checkbox"/>	<input type="checkbox"/>												
															TAWKH2380TG															
		5	TAWMN2400S32	●	121.8	139.6	164.6	224.6	220.3	32	WS355521T	TKY15T	WPT4405	MK1KS	23.9	TAWNH2390T	<input type="checkbox"/>	<input type="checkbox"/>												
															TAWKH2390TG															
															24.0	TAWNH2400T	●	121.8	139.6	164.6	224.6	220.3	32	WS355521T	TKY15T	WPT4405	MK1KS			
																												TAWKH2400TG		
	8	TAWLN2400S32	●	192.3	206.6	236.6	296.6	292.3	32	WS355521T	TKY15T	WPT4405	MK1KS	24.0	TAWNH2410T	<input type="checkbox"/>	<input type="checkbox"/>													
														TAWKH2410TG																
														24.2	TAWNH2420T	●	192.3	206.6	236.6	296.6	292.3	32	WS355521T	TKY15T	WPT4405	MK1KS				
																											TAWKH2420TG			
	5	TAWMN2500S32	●	127.0	145.1	170.1	230.1	225.6	32	WS406023T	TKY25T	WPT4405	MK1KS	24.3	TAWNH2430T	<input type="checkbox"/>	<input type="checkbox"/>													
														TAWKH2430TG																
														24.4	TAWNH2440T	●	127.0	145.1	170.1	230.1	225.6	32	WS406023T	TKY25T	WPT4405	MK1KS				
																											TAWKH2440TG			
24.5 25.4	3	TAWSN2500S32	●	78.0	93.1	115.1	175.1	170.6	32	WS406023T	TKY25T	WPT4405	MK1KS	24.5	* TAWNH2450T	●	<input type="checkbox"/>													
															TAWKH2450TG															
														24.6	TAWNH2460T	<input type="checkbox"/>	<input type="checkbox"/>													
															TAWKH2460TG															
		5	TAWMN2500S32	●	127.0	145.1	170.1	230.1	225.6	32	WS406023T	TKY25T	WPT4405	MK1KS	24.7	TAWNH2470T	<input type="checkbox"/>	<input type="checkbox"/>												
															TAWKH2470TG															
		8	TAWLN2500S32	●	200.5	215.1	245.1	305.1	300.6	32	WS406023T	TKY25T	WPT4405	MK1KS	24.8	TAWNH2480T	<input type="checkbox"/>	<input type="checkbox"/>												
															TAWKH2480TG															
		5	TAWMN2500S32	●	127.0	145.1	170.1	230.1	225.6	32	WS406023T	TKY25T	WPT4405	MK1KS	24.9	TAWNH2490T	<input type="checkbox"/>	<input type="checkbox"/>												
															TAWKH2490TG															
															25.0	TAWNH2500T	●	127.0	145.1	170.1	230.1	225.6	32	WS406023T	TKY25T	WPT4405	MK1KS			
																												TAWKH2500TG		
	8	TAWLN2500S32	●	200.5	215.1	245.1	305.1	300.6	32	WS406023T	TKY25T	WPT4405	MK1KS	25.1	TAWNH2510T	<input type="checkbox"/>	<input type="checkbox"/>													
														TAWKH2510TG																
														25.2	TAWNH2520T	●	200.5	215.1	245.1	305.1	300.6	32	WS406023T	TKY25T	WPT4405	MK1KS				
																											TAWKH2520TG			
	5	TAWMN2600S32	●	132.1	151.2	175.2	235.2	230.6	32	WS406024T	TKY25T	WPT4405	MK1KS	25.3	TAWNH2530T	<input type="checkbox"/>	<input type="checkbox"/>													
														TAWKH2530TG																
														25.4	TAWNH2540T	●	132.1	151.2	175.2	235.2	230.6	32	WS406024T	TKY25T	WPT4405	MK1KS				
																											TAWKH2540TG			
25.5 26.4	3	TAWSN2600S32	●	81.1	97.2	120.2	180.2	175.6	32	WS406024T	TKY25T	WPT4405	MK1KS	25.5	* TAWNH2550T	●	<input type="checkbox"/>													
															TAWKH2550TG															
														25.6	TAWNH2560T	<input type="checkbox"/>	<input type="checkbox"/>													
															TAWKH2560TG															
		5	TAWMN2600S32	●	132.1	151.2	175.2	235.2	230.6	32	WS406024T	TKY25T	WPT4405	MK1KS	25.7	TAWNH2570T	<input type="checkbox"/>	<input type="checkbox"/>												
															TAWKH2570TG															
		8	TAWLN2600S32	●	208.6	223.2	253.2	313.2	308.6	32	WS406024T	TKY25T	WPT4405	MK1KS	25.8	TAWNH2580T	<input type="checkbox"/>	<input type="checkbox"/>												
															TAWKH2580TG															
		5	TAWMN2600S32	●	132.1	151.2	175.2	235.2	230.6	32	WS406024T	TKY25T	WPT4405	MK1KS	25.9	TAWNH2590T	<input type="checkbox"/>	<input type="checkbox"/>												
															TAWKH2590TG															
															26.0	TAWNH2600T	●	132.1	151.2	175.2	235.2	230.6	32	WS406024T	TKY25T	WPT4405	MK1KS			
																												TAWKH2600TG		
	8	TAWLN2600S32	●	208.6	223.2	253.2	313.2	308.6	32	WS406024T	TKY25T	WPT4405	MK1KS	26.1	TAWNH2610T	<input type="checkbox"/>	<input type="checkbox"/>													
														TAWKH2610TG																
														26.2	TAWNH2620T	●	208.6	223.2	253.2	313.2	308.6	32	WS406024T	TKY25T	WPT4405	MK1KS				
																											TAWKH2620TG			
	5	TAWMN2600S32	●	132.1	151.2	175.2	235.2	230.6	32	WS406024T	TKY25T	WPT4405	MK1KS	26.3	TAWNH2630T	<input type="checkbox"/>	<input type="checkbox"/>													
														TAWKH2630TG																
														26.4	TAWNH2640T	●	132.1	151.2	175.2	235.2	230.6	32	WS406024T	TKY25T	WPT4405	MK1KS				
																											TAWKH2640TG			

Примечание 1) Приведенные выше размеры (*) указаны для установки пластин.

Примечание 2) Пожалуйста, свяжитесь с нами если Вы не нашли нужную геометрию в данном каталоге (могут быть заказаны другие диаметры и длины).

● : Есть на складе. □ : Нет на складе, выпускается исключительно под заказ.
(Примечание : 1 пластина в наборе)

DC (мм)	Глубина сверления (L/D)	Державка		Размеры (мм)										Пластина			
		Обозначение	Наличие	LU	LBX	LH	OAL	LF	DCON					DC (мм)	Обозначение	Наличие	
																VP15TF	VP10H
26.5 27.4	3	TAWSN2700S32	●	84.3	99.4	120.4	180.4	175.6	32	WS406024T	TKY25T	WPT4405	МК1КС	26.5	* TAWNH2650T	●	<input type="checkbox"/>
															TAWKH2650TG		
														26.6	TAWNH2660T	<input type="checkbox"/>	<input type="checkbox"/>
															TAWKH2660TG		
	5	TAWMN2700S32	●	137.3	156.4	180.4	240.4	235.6	32	WS406024T	TKY25T	WPT4405	МК1КС	26.7	TAWNH2670T	<input type="checkbox"/>	<input type="checkbox"/>
															TAWKH2670TG		
														26.8	TAWNH2680T	<input type="checkbox"/>	<input type="checkbox"/>
															TAWKH2680TG		
	8	TAWLN2700S32	●	216.8	231.4	261.4	321.4	316.6	32	WS406024T	TKY25T	WPT4405	МК1КС	26.9	TAWNH2690T	<input type="checkbox"/>	<input type="checkbox"/>
															TAWKH2690TG		
														27.0	TAWNH2700T	●	<input type="checkbox"/>
															TAWKH2700TG		
27.5 28.4	3	TAWSN2800S32	●	87.5	102.2	125.2	185.2	180.2	32	WS508026T	TKY27T	WPT4405	МК1КС	27.1	TAWNH2710T	<input type="checkbox"/>	<input type="checkbox"/>
															TAWKH2710TG		
														27.2	TAWNH2720T	<input type="checkbox"/>	<input type="checkbox"/>
															TAWKH2720TG		
	5	TAWMN2800S32	●	142.5	162.2	185.2	245.2	240.2	32	WS508026T	TKY27T	WPT4405	МК1КС	27.3	TAWNH2730T	<input type="checkbox"/>	<input type="checkbox"/>
															TAWKH2730TG		
														27.4	TAWNH2740T	<input type="checkbox"/>	<input type="checkbox"/>
															TAWKH2740TG		
	8	TAWLN2800S32	●	225.0	239.2	269.2	329.2	324.2	32	WS508026T	TKY27T	WPT4405	МК1КС	27.5	* TAWNH2750T	●	<input type="checkbox"/>
															TAWKH2750TG		
														27.6	TAWNH2760T	<input type="checkbox"/>	<input type="checkbox"/>
															TAWKH2760TG		
28.5 29.4	3	TAWSN2900S32	●	90.7	105.4	130.4	190.4	185.2	32	WS508027T	TKY27T	WPT4405	МК1КС	27.7	TAWNH2770T	<input type="checkbox"/>	<input type="checkbox"/>
															TAWKH2770TG		
														27.8	TAWNH2780T	<input type="checkbox"/>	<input type="checkbox"/>
															TAWKH2780TG		
	5	TAWMN2900S32	●	147.7	167.4	190.4	250.4	245.2	32	WS508027T	TKY27T	WPT4405	МК1КС	27.9	TAWNH2790T	<input type="checkbox"/>	<input type="checkbox"/>
															TAWKH2790TG		
														28.0	TAWNH2800T	●	<input type="checkbox"/>
															TAWKH2800TG		
	8	TAWLN2900S32	●	225.0	239.2	269.2	329.2	324.2	32	WS508026T	TKY27T	WPT4405	МК1КС	28.1	TAWNH2810T	<input type="checkbox"/>	<input type="checkbox"/>
															TAWKH2810TG		
														28.2	TAWNH2820T	<input type="checkbox"/>	<input type="checkbox"/>
															TAWKH2820TG		
28.5 29.4	3	TAWSN2900S32	●	90.7	105.4	130.4	190.4	185.2	32	WS508027T	TKY27T	WPT4405	МК1КС	28.3	TAWNH2830T	<input type="checkbox"/>	<input type="checkbox"/>
															TAWKH2830TG		
														28.4	TAWNH2840T	<input type="checkbox"/>	<input type="checkbox"/>
															TAWKH2840TG		
	5	TAWMN2900S32	●	147.7	167.4	190.4	250.4	245.2	32	WS508027T	TKY27T	WPT4405	МК1КС	28.5	* TAWNH2850T	●	<input type="checkbox"/>
															TAWKH2850TG		
														28.6	TAWNH2860T	<input type="checkbox"/>	<input type="checkbox"/>
															TAWKH2860TG		
	8	TAWLN2900S32	●	233.2	247.4	277.4	337.4	332.2	32	WS508027T	TKY27T	WPT4405	МК1КС	28.7	TAWNH2870T	<input type="checkbox"/>	<input type="checkbox"/>
															TAWKH2870TG		
														28.8	TAWNH2880T	<input type="checkbox"/>	<input type="checkbox"/>
															TAWKH2880TG		
5	TAWMN2900S32	●	147.7	167.4	190.4	250.4	245.2	32	WS508027T	TKY27T	WPT4405	МК1КС	28.9	TAWNH2890T	<input type="checkbox"/>	<input type="checkbox"/>	
														TAWKH2890TG			
													29.0	TAWNH2900T	●	<input type="checkbox"/>	
														TAWKH2900TG			
8	TAWLN2900S32	●	233.2	247.4	277.4	337.4	332.2	32	WS508027T	TKY27T	WPT4405	МК1КС	29.1	TAWNH2910T	<input type="checkbox"/>	<input type="checkbox"/>	
														TAWKH2910TG			
													29.2	TAWNH2920T	<input type="checkbox"/>	<input type="checkbox"/>	
														TAWKH2920TG			
5	TAWMN2900S32	●	147.7	167.4	190.4	250.4	245.2	32	WS508027T	TKY27T	WPT4405	МК1КС	29.3	TAWNH2930T	<input type="checkbox"/>	<input type="checkbox"/>	
														TAWKH2930TG			
													29.4	TAWNH2940T	<input type="checkbox"/>	<input type="checkbox"/>	
														TAWKH2940TG			

М
ИНСТРУМЕНТ ДЛЯ
СВЕРЛЕНИЯ

ОПИСАНИЕ ПЛАСТИН > M155
РЕЖИМЫ РЕЗАНИЯ > M157
РЕКОМЕНДАЦИИ > M158

ЗАПАСНЫЕ ЧАСТИ > N001
ТЕХНИЧЕСКИЕ ДАННЫЕ > P001

M153

ИНСТРУМЕНТ ДЛЯ СВЕРЛЕНИЯ (СВЕРЛА СО СМЕННЫМИ ПЛАСТИНАМИ)

ТВЕРДЫЙ
СПЛАВ

TAW

М

ИНСТРУМЕНТ ДЛЯ
СВЕРЛЕНИЯ

DC (мм)	Глубина сверления (L/D)	Державка		Размеры (мм)										Пластина			
		Обозначение	Наличие	LU	LBX	LH	OAL	LF	DCON					DC (мм)	Обозначение	Наличие	
															VP15TF	VP10H	
29.5 30.4	3	TAWSN3000S32	●	93.9	109.6	130.6	190.6	185.2	32	WS508027T	TKY27T	WPT4405	МК1KS	29.5	* TAWNH2950T	●	<input type="checkbox"/>
															TAWKH2950TG		
														29.6	TAWNH2960T	<input type="checkbox"/>	<input type="checkbox"/>
		TAWKH2960TG															
		29.7	TAWNH2970T	<input type="checkbox"/>	<input type="checkbox"/>												
		TAWKH2970TG															
		29.8	TAWNH2980T	<input type="checkbox"/>	<input type="checkbox"/>												
		TAWKH2980TG															
		29.9	TAWNH2990T	<input type="checkbox"/>	<input type="checkbox"/>												
		TAWKH2990TG															
		30.0	TAWNH3000T	●	<input type="checkbox"/>												
		TAWKH3000TG															
	30.1	TAWNH3010T	<input type="checkbox"/>	<input type="checkbox"/>													
	TAWKH3010TG																
	30.2	TAWNH3020T	<input type="checkbox"/>	<input type="checkbox"/>													
	TAWKH3020TG																
	30.3	TAWNH3030T	<input type="checkbox"/>	<input type="checkbox"/>													
	TAWKH3030TG																
	30.4	TAWNH3040T	<input type="checkbox"/>	<input type="checkbox"/>													
	TAWKH3040TG																
	8	TAWLN3000S32	●	241.4	255.6	290.6	350.6	345.2	32	WS508027T	TKY27T	WPT4405	МК1KS				

Примечание 1) Приведенные выше размеры (*) указаны для установки пластин.

Примечание 2) Пожалуйста, свяжитесь с нами если Вы не нашли нужную геометрию в данном каталоге (могут быть заказаны другие диаметры и длины).

● : Есть на складе. □ : Нет на складе, выпускается исключительно под заказ.
(Примечание : 1 пластина в наборе)

ПЛАСТИНЫ

Тип Н

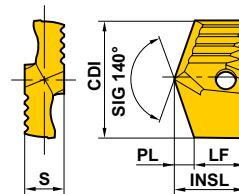

M

ИНСТРУМЕНТ ДЛЯ
СВЕРЛЕНИЯ

Обозначение	Наличие		Размеры (мм)					Применяемый корпус
	VP15TF	VP10H	CDI	INSL	LF	PL	S	
TAWNH1850T	●	□	18.5	12.7	9.3	3.4	7.0	TAWSN 1900S25
TAWNH1860T	●	□	18.6	12.7	9.3	3.4	7.0	
TAWNH1870T	●	□	18.7	12.7	9.3	3.4	7.0	
TAWNH1880T	●	□	18.8	12.7	9.3	3.4	7.0	
TAWNH1890T	●	□	18.9	12.7	9.3	3.4	7.0	
TAWNH1900T	●	□	19.0	12.7	9.2	3.5	7.0	
TAWNH1910T	●	□	19.1	12.7	9.2	3.5	7.0	
TAWNH1920T	●	□	19.2	12.7	9.2	3.5	7.0	
TAWNH1930T	●	□	19.3	12.7	9.2	3.5	7.0	
TAWNH1940T	●	□	19.4	12.7	9.2	3.5	7.0	
TAWNH1950T	●	□	19.5	12.6	9.1	3.5	7.0	TAWSN 2000S25
TAWNH1960T	●	□	19.6	12.7	9.1	3.6	7.0	
TAWNH1970T	●	□	19.7	12.7	9.1	3.6	7.0	
TAWNH1980T	●	□	19.8	12.7	9.1	3.6	7.0	
TAWNH1990T	●	□	19.9	12.7	9.1	3.6	7.0	
TAWNH2000T	●	□	20.0	12.6	9.0	3.6	7.0	
TAWNH2010T	□	□	20.1	12.7	9.0	3.7	7.0	
TAWNH2020T	□	□	20.2	12.7	9.0	3.7	7.0	
TAWNH2030T	□	□	20.3	12.7	9.0	3.7	7.0	
TAWNH2040T	□	□	20.4	12.7	9.0	3.7	7.0	
TAWNH2050T	●	□	20.5	12.6	8.9	3.7	7.0	TAWSN 2100S25
TAWNH2060T	□	□	20.6	12.6	8.9	3.7	7.0	
TAWNH2070T	□	□	20.7	12.7	8.9	3.8	7.0	
TAWNH2080T	□	□	20.8	12.7	8.9	3.8	7.0	
TAWNH2090T	□	□	20.9	12.7	8.9	3.8	7.0	
TAWNH2100T	●	□	21.0	12.6	8.8	3.8	7.0	
TAWNH2110T	□	□	21.1	12.6	8.8	3.8	7.0	
TAWNH2120T	□	□	21.2	12.7	8.8	3.9	7.0	
TAWNH2130T	□	□	21.3	12.7	8.8	3.9	7.0	
TAWNH2140T	□	□	21.4	12.7	8.8	3.9	7.0	
TAWNH2150T	●	□	21.5	14.5	10.6	3.9	8.0	TAWSN 2200S25
TAWNH2160T	□	□	21.6	14.5	10.6	3.9	8.0	
TAWNH2170T	□	□	21.7	14.5	10.6	3.9	8.0	
TAWNH2180T	□	□	21.8	14.6	10.6	4.0	8.0	
TAWNH2190T	□	□	21.9	14.6	10.6	4.0	8.0	
TAWNH2200T	●	□	22.0	14.5	10.5	4.0	8.0	
TAWNH2210T	□	□	22.1	14.5	10.5	4.0	8.0	
TAWNH2220T	□	□	22.2	14.5	10.5	4.0	8.0	
TAWNH2230T	□	□	22.3	14.6	10.5	4.1	8.0	
TAWNH2240T	□	□	22.4	14.6	10.5	4.1	8.0	

Обозначение	Наличие		Размеры (мм)					Применяемый корпус
	VP15TF	VP10H	CDI	INSL	LF	PL	S	
TAWNH2250T	●	□	22.5	14.5	10.4	4.1	8.0	TAWSN 2300S25
TAWNH2260T	□	□	22.6	14.5	10.4	4.1	8.0	
TAWNH2270T	□	□	22.7	14.5	10.4	4.1	8.0	
TAWNH2280T	□	□	22.8	14.5	10.4	4.1	8.0	
TAWNH2290T	□	□	22.9	14.6	10.4	4.2	8.0	
TAWNH2300T	●	□	23.0	14.5	10.3	4.2	8.0	
TAWNH2310T	□	□	23.1	14.5	10.3	4.2	8.0	
TAWNH2320T	□	□	23.2	14.5	10.3	4.2	8.0	
TAWNH2330T	□	□	23.3	14.5	10.3	4.2	8.0	
TAWNH2340T	□	□	23.4	14.6	10.3	4.3	8.0	
TAWNH2350T	●	□	23.5	14.5	10.2	4.3	8.0	TAWSN 2400S32
TAWNH2360T	□	□	23.6	14.5	10.2	4.3	8.0	
TAWNH2370T	□	□	23.7	14.5	10.2	4.3	8.0	
TAWNH2380T	□	□	23.8	14.5	10.2	4.3	8.0	
TAWNH2390T	□	□	23.9	14.5	10.2	4.3	8.0	
TAWNH2400T	●	□	24.0	14.5	10.1	4.4	8.0	
TAWNH2410T	□	□	24.1	14.5	10.1	4.4	8.0	
TAWNH2420T	□	□	24.2	14.5	10.1	4.4	8.0	
TAWNH2430T	□	□	24.3	14.5	10.1	4.4	8.0	
TAWNH2440T	□	□	24.4	14.5	10.1	4.4	8.0	
TAWNH2450T	●	□	24.5	16.2	11.7	4.5	9.0	TAWSN 2500S32
TAWNH2460T	□	□	24.6	16.2	11.7	4.5	9.0	
TAWNH2470T	□	□	24.7	16.2	11.7	4.5	9.0	
TAWNH2480T	□	□	24.8	16.2	11.7	4.5	9.0	
TAWNH2490T	□	□	24.9	16.2	11.7	4.5	9.0	
TAWNH2500T	●	□	25.0	16.1	11.6	4.5	9.0	
TAWNH2510T	□	□	25.1	16.2	11.6	4.6	9.0	
TAWNH2520T	□	□	25.2	16.2	11.6	4.6	9.0	
TAWNH2530T	□	□	25.3	16.2	11.6	4.6	9.0	
TAWNH2540T	□	□	25.4	16.2	11.6	4.6	9.0	
TAWNH2550T	●	□	25.5	16.1	11.5	4.6	9.0	TAWSN 2600S32
TAWNH2560T	□	□	25.6	16.2	11.5	4.7	9.0	
TAWNH2570T	□	□	25.7	16.2	11.5	4.7	9.0	
TAWNH2580T	□	□	25.8	16.2	11.5	4.7	9.0	
TAWNH2590T	□	□	25.9	16.2	11.5	4.7	9.0	
TAWNH2600T	●	□	26.0	16.1	11.4	4.7	9.0	
TAWNH2610T	□	□	26.1	16.1	11.4	4.7	9.0	
TAWNH2620T	□	□	26.2	16.2	11.4	4.8	9.0	
TAWNH2630T	□	□	26.3	16.2	11.4	4.8	9.0	
TAWNH2640T	□	□	26.4	16.2	11.4	4.8	9.0	

ИНСТРУМЕНТ ДЛЯ СВЕРЛЕНИЯ (СВЕРЛА СО СМЕННЫМИ ПЛАСТИНАМИ)

ТВЕРДЫЙ
СПЛАВ

TAW

M

ИНСТРУМЕНТ ДЛЯ
СВЕРЛЕНИЯ

Обозначение	Наличие		Размеры (мм)					Применяемый корпус
	VP15TF	VP10H	CDI	INSL	LF	PL	S	
TAWNH2650T	●	□	26.5	16.1	11.3	4.8	9.0	TAWSN 2700S32
TAWNH2660T	□	□	26.6	16.1	11.3	4.8	9.0	
TAWNH2670T	□	□	26.7	16.2	11.3	4.9	9.0	
TAWNH2680T	□	□	26.8	16.2	11.3	4.9	9.0	
TAWNH2690T	□	□	26.9	16.2	11.3	4.9	9.0	
TAWNH2700T	●	□	27.0	16.1	11.2	4.9	9.0	
TAWNH2710T	□	□	27.1	16.1	11.2	4.9	9.0	
TAWNH2720T	□	□	27.2	16.1	11.2	4.9	9.0	
TAWNH2730T	□	□	27.3	16.2	11.2	5.0	9.0	
TAWNH2740T	□	□	27.4	16.2	11.2	5.0	9.0	
TAWNH2750T	●	□	27.5	17.3	12.3	5.0	10.0	TAWSN 2800S32
TAWNH2760T	□	□	27.6	17.3	12.3	5.0	10.0	
TAWNH2770T	□	□	27.7	17.3	12.3	5.0	10.0	
TAWNH2780T	□	□	27.8	17.4	12.3	5.1	10.0	
TAWNH2790T	□	□	27.9	17.4	12.3	5.1	10.0	
TAWNH2800T	●	□	28.0	17.3	12.2	5.1	10.0	
TAWNH2810T	□	□	28.1	17.3	12.2	5.1	10.0	
TAWNH2820T	□	□	28.2	17.3	12.2	5.1	10.0	
TAWNH2830T	□	□	28.3	17.4	12.2	5.2	10.0	
TAWNH2840T	□	□	28.4	17.4	12.2	5.2	10.0	

Обозначение	Наличие		Размеры (мм)					Применяемый корпус
	VP15TF	VP10H	CDI	INSL	LF	PL	S	
TAWNH2850T	●	□	28.5	17.3	12.1	5.2	10.0	TAWSN 2900S32
TAWNH2860T	□	□	28.6	17.3	12.1	5.2	10.0	
TAWNH2870T	□	□	28.7	17.3	12.1	5.2	10.0	
TAWNH2880T	□	□	28.8	17.3	12.1	5.2	10.0	
TAWNH2890T	□	□	28.9	17.4	12.1	5.3	10.0	
TAWNH2900T	●	□	29.0	17.3	12.0	5.3	10.0	
TAWNH2910T	□	□	29.1	17.3	12.0	5.3	10.0	
TAWNH2920T	□	□	29.2	17.3	12.0	5.3	10.0	
TAWNH2930T	□	□	29.3	17.3	12.0	5.3	10.0	
TAWNH2940T	□	□	29.4	17.4	12.0	5.4	10.0	
TAWNH2950T	●	□	29.5	17.3	11.9	5.4	10.0	TAWSN 3000S32
TAWNH2960T	□	□	29.6	17.3	11.9	5.4	10.0	
TAWNH2970T	□	□	29.7	17.3	11.9	5.4	10.0	
TAWNH2980T	□	□	29.8	17.3	11.9	5.4	10.0	
TAWNH2990T	□	□	29.9	17.3	11.9	5.4	10.0	
TAWNH3000T	●	□	30.0	17.3	11.8	5.5	10.0	
TAWNH3010T	□	□	30.1	17.3	11.8	5.5	10.0	
TAWNH3020T	□	□	30.2	17.3	11.8	5.5	10.0	
TAWNH3030T	□	□	30.3	17.3	11.8	5.5	10.0	
TAWNH3040T	□	□	30.4	17.3	11.8	5.5	10.0	

● : Есть на складе. □ : Нет на складе, выпускается исключительно под заказ.

(Примечание : 1 пластина в наборе)

РЕЖИМЫ РЕЗАНИЯ > M157

РЕКОМЕНДАЦИИ > M158

ЗАПАСНЫЕ ЧАСТИ > N001

ТЕХНИЧЕСКИЕ ДАННЫЕ > P001

РЕКОМЕНДУЕМЫЕ РЕЖИМЫ РЕЗАНИЯ

Обрабатываемый материал	Диаметр сверла Условия Твердость	φ 18.5—φ 21.4		φ 21.5—φ 24.4	
		Скорость резания (м/мин)	Подача (мм/об)	Скорость резания (м/мин)	Подача (мм/об)
P Малоуглеродистые стали	≤180НВ	90 (70—110)	0.25 (0.20—0.30)	100 (80—120)	0.30 (0.25—0.35)
	180—280НВ	80 (60—100)	0.25 (0.20—0.30)	90 (70—110)	0.30 (0.25—0.35)
	280—350НВ	70 (50—90)	0.20 (0.15—0.25)	80 (60—100)	0.25 (0.20—0.30)
M Нержавеющая сталь	≤200НВ	60 (50—70)	0.20 (0.15—0.22)	60 (50—70)	0.20 (0.15—0.22)
K Чугун	Предел прочности ≤350МПа	120 (60—140)	0.25 (0.20—0.30)	130 (80—150)	0.35 (0.25—0.40)
	Предел прочности ≤450МПа	80 (60—90)	0.25 (0.20—0.30)	90 (60—100)	0.30 (0.25—0.35)

Обрабатываемый материал	Диаметр сверла Условия Твердость	φ 24.5—φ 27.4		φ 27.5—φ 30.4	
		Скорость резания (м/мин)	Подача (мм/об)	Скорость резания (м/мин)	Подача (мм/об)
P Малоуглеродистые стали	≤180НВ	110 (80—120)	0.30 (0.25—0.35)	110 (80—120)	0.30 (0.25—0.35)
	180—280НВ	100 (80—120)	0.30 (0.25—0.35)	100 (80—120)	0.30 (0.25—0.35)
	280—350НВ	90 (70—110)	0.25 (0.20—0.30)	90 (70—110)	0.25 (0.20—0.30)
M Нержавеющая сталь	≤200НВ	70 (60—80)	0.25 (0.20—0.28)	70 (60—80)	0.25 (0.20—0.28)
K Чугун	Предел прочности ≤350МПа	140 (90—160)	0.35 (0.25—0.40)	140 (90—160)	0.40 (0.30—0.45)
	Предел прочности ≤450МПа	100 (80—110)	0.30 (0.25—0.35)	100 (80—110)	0.30 (0.25—0.35)

Примечание 1) Для обработки низкоуглеродистой и нержавеющей стали мы рекомендуем использовать хонингование типа Н.

Примечание 2) Рекомендовано для использования только при высокой жесткости станка и крепления. Используйте систему внутреннего охлаждения при обработке нержавеющей стали. (Не рекомендуется обработка с масляным туманом).

ИНСТРУМЕНТ ДЛЯ СВЕРЛЕНИЯ (СВЕРЛА СО СМЕННЫМИ ПЛАСТИНАМИ)

ТВЕРДЫЙ СПЛАВ

MVX

- Идеальное сочетание внешней пластины CVD и внутренней пластины PVD.
- Корпус высокой жесткости позволяет выполнять обработку глубоких отверстий L/D=6.

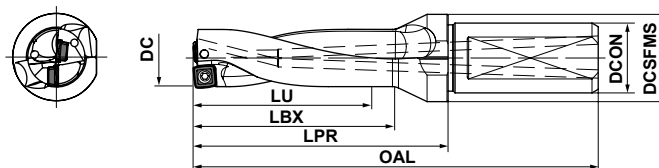

M

ИНСТРУМЕНТ ДЛЯ СВЕРЛЕНИЯ

Максимальное смещение при токарной обработке

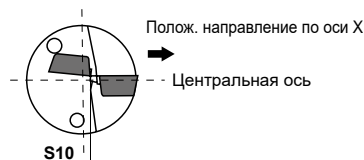

L/D	Допуск на мех. обработку(ориентировочный) (мм)		
	ø14.0-ø33.0	ø33.5-ø47.0	ø48.0-ø63.0
2D, 3D	0 +0.25	0 +0.3	0 +0.3
4D, 5D	0 +0.35	0 +0.4	0 +0.45
6D	0 +0.45	0 +0.6	

DC (мм)	Глубина отверстия (L/D)	Обозначение	Наличие	Зубья	Размеры (мм)						S10 (мм)	Insert	Винт	Ключ
					LU	LBX	LPR	OAL	DCON	DCSFMS				
NEW 14.0	2	MVX1400X2F20	●	2	28	35	50	93	20	25	0.6	SOX05	TPS20-1	TIP06F
	3	MVX1400X3F20	●	2	42	49	64	107	20	25	0.6	SOX05	TPS20-1	TIP06F
	4	MVX1400X4F20	●	2	56	63	78	121	20	25	0.6	SOX05	TPS20-1	TIP06F
	5	MVX1400X5F20	●	2	70	77	92	135	20	25	0.6	SOX05	TPS20-1	TIP06F
NEW 14.5	2	MVX1450X2F20	●	2	29	36	51	94	20	25	0.5	SOX05	TPS20-1	TIP06F
	3	MVX1450X3F20	●	2	43.5	50.5	65.5	108.5	20	25	0.5	SOX05	TPS20-1	TIP06F
	4	MVX1450X4F20	●	2	58	65	80	123	20	25	0.5	SOX05	TPS20-1	TIP06F
	5	MVX1450X5F20	●	2	72.5	79.5	94.5	137.5	20	25	0.5	SOX05	TPS20-1	TIP06F
NEW 15.0	2	MVX1500X2F20	●	2	30	37	52	95	20	25	0.35	SOX05	TPS20-1	TIP06F
	3	MVX1500X3F20	●	2	45	52	67	110	20	25	0.35	SOX05	TPS20-1	TIP06F
	4	MVX1500X4F20	●	2	60	67	82	125	20	25	0.35	SOX05	TPS20-1	TIP06F
	5	MVX1500X5F20	●	2	75	82	97	140	20	25	0.35	SOX05	TPS20-1	TIP06F
NEW 15.5	2	MVX1550X2F20	●	2	31	38	53	96	20	25	0.3	SOX05	TPS20-1	TIP06F
	3	MVX1550X3F20	●	2	46.5	53.5	68.5	111.5	20	25	0.3	SOX05	TPS20-1	TIP06F
	4	MVX1550X4F20	●	2	62	69	84	127	20	25	0.3	SOX05	TPS20-1	TIP06F
	5	MVX1550X5F20	●	2	77.5	84.5	99.5	142.5	20	25	0.3	SOX05	TPS20-1	TIP06F
NEW 16.0	2	MVX1600X2F20	●	2	32	39	54	97	20	25	0.25	SOX05	TPS20-1	TIP06F
	3	MVX1600X3F20	●	2	48	55	70	113	20	25	0.25	SOX05	TPS20-1	TIP06F
	4	MVX1600X4F20	●	2	64	71	86	129	20	25	0.25	SOX05	TPS20-1	TIP06F
	5	MVX1600X5F20	●	2	80	87	102	145	20	25	0.25	SOX05	TPS20-1	TIP06F
NEW 16.5	2	MVX1650X2F20	●	2	33	40	55	98	20	25	0.25	SOX05	TPS20-1	TIP06F
	3	MVX1650X3F20	●	2	49.5	56.5	71.5	114.5	20	25	0.25	SOX05	TPS20-1	TIP06F
	4	MVX1650X4F20	●	2	66	73	88	131	20	25	0.25	SOX05	TPS20-1	TIP06F
	5	MVX1650X5F20	●	2	82.5	89.5	104.5	147.5	20	25	0.25	SOX05	TPS20-1	TIP06F
17.0	2	MVX1700X2F20	●	2	34	41	56	99	20	25	0.5	SOX06	TPS25	TIP07F
	3	MVX1700X3F20	●	2	51	58	73	116	20	25	0.5	SOX06	TPS25	TIP07F
	4	MVX1700X4F20	●	2	68	75	90	133	20	25	0.5	SOX06	TPS25	TIP07F
	5	MVX1700X5F20	●	2	85	92	107	150	20	25	0.5	SOX06	TPS25	TIP07F
	6	MVX1700X6F20	●	2	102	109	124	167	20	25	0.5	SOX06	TPS25	TIP07F

* Момент затяжки (N • м) : TPS20-1=0.6, TPS25=1.0

● : Есть на складе.

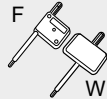
DC (мм)	Глубина отверстия (L/D)	Обозначение	Наличие	Зубья	Размеры (мм)						S10 (мм)	Insert		
					LU	LBX	LPR	OAL	DCON	DCSFMS				
17.5	2	MVX1750X2F25	●	2	35	42	62	112	25	32	0.45	SOX06	TPS25	TIP07F
	3	MVX1750X3F25	●	2	52.5	59.5	79.5	129.5	25	32	0.45	SOX06	TPS25	TIP07F
	4	MVX1750X4F25	●	2	70	77	97	147	25	32	0.45	SOX06	TPS25	TIP07F
	5	MVX1750X5F25	●	2	87.5	94.5	114.5	164.5	25	32	0.45	SOX06	TPS25	TIP07F
	6	MVX1750X6F25	●	2	105	112	132	182	25	32	0.45	SOX06	TPS25	TIP07F
18.0	2	MVX1800X2F25	●	2	36	43	63	113	25	32	0.4	SOX06	TPS25	TIP07F
	3	MVX1800X3F25	●	2	54	61	81	131	25	32	0.4	SOX06	TPS25	TIP07F
	4	MVX1800X4F25	●	2	72	79	99	149	25	32	0.4	SOX06	TPS25	TIP07F
	5	MVX1800X5F25	●	2	90	97	117	167	25	32	0.4	SOX06	TPS25	TIP07F
	6	MVX1800X6F25	●	2	108	115	135	185	25	32	0.4	SOX06	TPS25	TIP07F
18.5	2	MVX1850X2F25	●	2	37	44	64	114	25	32	0.35	SOX06	TPS25	TIP07F
	3	MVX1850X3F25	●	2	55.5	62.5	82.5	132.5	25	32	0.35	SOX06	TPS25	TIP07F
	4	MVX1850X4F25	●	2	74	81	101	151	25	32	0.35	SOX06	TPS25	TIP07F
	5	MVX1850X5F25	●	2	92.5	99.5	119.5	169.5	25	32	0.35	SOX06	TPS25	TIP07F
	6	MVX1850X6F25	●	2	111	118	138	188	25	32	0.35	SOX06	TPS25	TIP07F
19.0	2	MVX1900X2F25	●	2	38	45	65	115	25	32	0.3	SOX06	TPS25	TIP07F
	3	MVX1900X3F25	●	2	57	64	84	134	25	32	0.3	SOX06	TPS25	TIP07F
	4	MVX1900X4F25	●	2	76	83	103	153	25	32	0.3	SOX06	TPS25	TIP07F
	5	MVX1900X5F25	●	2	95	102	122	172	25	32	0.3	SOX06	TPS25	TIP07F
	6	MVX1900X6F25	●	2	114	121	141	191	25	32	0.3	SOX06	TPS25	TIP07F
19.5	2	MVX1950X2F25	●	2	39	46	66	116	25	32	0.25	SOX06	TPS25	TIP07F
	3	MVX1950X3F25	●	2	58.5	65.5	85.5	135.5	25	32	0.25	SOX06	TPS25	TIP07F
	4	MVX1950X4F25	●	2	78	85	105	155	25	32	0.25	SOX06	TPS25	TIP07F
	5	MVX1950X5F25	●	2	97.5	104.5	124.5	174.5	25	32	0.25	SOX06	TPS25	TIP07F
	6	MVX1950X6F25	●	2	117	124	144	194	25	32	0.25	SOX06	TPS25	TIP07F
20.0	2	MVX2000X2F25	●	2	40	47	67	117	25	32	0.6	SOX07	TPS3	TIP10W
	3	MVX2000X3F25	●	2	60	67	87	137	25	32	0.6	SOX07	TPS3	TIP10W
	4	MVX2000X4F25	●	2	80	87	107	157	25	32	0.6	SOX07	TPS3	TIP10W
	5	MVX2000X5F25	●	2	100	107	127	177	25	32	0.6	SOX07	TPS3	TIP10W
	6	MVX2000X6F25	●	2	120	127	147	197	25	32	0.6	SOX07	TPS3	TIP10W
20.5	2	MVX2050X2F25	●	2	41	48	68	118	25	32	0.55	SOX07	TPS3	TIP10W
	3	MVX2050X3F25	●	2	61.5	68.5	88.5	138.5	25	32	0.55	SOX07	TPS3	TIP10W
21.0	2	MVX2100X2F25	●	2	42	49	69	119	25	32	0.5	SOX07	TPS3	TIP10W
	3	MVX2100X3F25	●	2	63	70	90	140	25	32	0.5	SOX07	TPS3	TIP10W
	4	MVX2100X4F25	●	2	84	91	111	161	25	32	0.5	SOX07	TPS3	TIP10W
	5	MVX2100X5F25	●	2	105	112	132	182	25	32	0.5	SOX07	TPS3	TIP10W
	6	MVX2100X6F25	●	2	126	133	153	203	25	32	0.5	SOX07	TPS3	TIP10W
21.5	2	MVX2150X2F25	●	2	43	50	70	120	25	32	0.45	SOX07	TPS3	TIP10W
	3	MVX2150X3F25	●	2	64.5	71.5	91.5	141.5	25	32	0.45	SOX07	TPS3	TIP10W
22.0	2	MVX2200X2F25	●	2	44	51	71	121	25	32	0.4	SOX07	TPS3	TIP10W
	3	MVX2200X3F25	●	2	66	73	93	143	25	32	0.4	SOX07	TPS3	TIP10W
	4	MVX2200X4F25	●	2	88	95	115	165	25	32	0.4	SOX07	TPS3	TIP10W
	5	MVX2200X5F25	●	2	110	117	137	187	25	32	0.4	SOX07	TPS3	TIP10W
	6	MVX2200X6F25	●	2	132	139	159	209	25	32	0.4	SOX07	TPS3	TIP10W
22.5	2	MVX2250X2F25	●	2	45	52	72	122	25	32	0.35	SOX07	TPS3	TIP10W
	3	MVX2250X3F25	●	2	67.5	74.5	94.5	144.5	25	32	0.35	SOX07	TPS3	TIP10W

* Момент затяжки (N • м) : TPS25=1.0, TPS3=2.0



ИНСТРУМЕНТ ДЛЯ СВЕРЛЕНИЯ (СВЕРЛА СО СМЕННЫМИ ПЛАСТИНАМИ)

MVX

ТВЕРДЫЙ
СПЛАВ



M

ИНСТРУМЕНТ ДЛЯ
СВЕРЛЕНИЯ

DC (мм)	Глубина отверстия (L/D)	Обозначение	Наличие	Зубья	Размеры (мм)						S10 (мм)	Insert		
					LU	LBX	LPR	OAL	DCON	DCSFMS				
23.0	2	MVX2300X2F25	●	2	46	53	73	123	25	32	0.8	SOX08	TPS351	TIP10W
	3	MVX2300X3F25	●	2	69	76	96	146	25	32	0.8	SOX08	TPS351	TIP10W
	4	MVX2300X4F25	●	2	92	99	119	169	25	32	0.8	SOX08	TPS351	TIP10W
	5	MVX2300X5F25	●	2	115	122	142	192	25	32	0.8	SOX08	TPS351	TIP10W
	6	MVX2300X6F25	●	2	138	145	165	215	25	32	0.8	SOX08	TPS351	TIP10W
23.5	2	MVX2350X2F25	●	2	47	54	74	124	25	32	0.75	SOX08	TPS351	TIP10W
	3	MVX2350X3F25	●	2	70.5	77.5	97.5	147.5	25	32	0.75	SOX08	TPS351	TIP10W
24.0	2	MVX2400X2F25	●	2	48	55	75	125	25	32	0.7	SOX08	TPS351	TIP10W
	3	MVX2400X3F25	●	2	72	79	99	149	25	32	0.7	SOX08	TPS351	TIP10W
	4	MVX2400X4F25	●	2	96	103	123	173	25	32	0.7	SOX08	TPS351	TIP10W
	5	MVX2400X5F25	●	2	120	127	147	197	25	32	0.7	SOX08	TPS351	TIP10W
	6	MVX2400X6F25	●	2	144	151	171	221	25	32	0.7	SOX08	TPS351	TIP10W
24.5	2	MVX2450X2F25	●	2	49	56	76	126	25	32	0.65	SOX08	TPS351	TIP10W
	3	MVX2450X3F25	●	2	73.5	80.5	100.5	150.5	25	32	0.65	SOX08	TPS351	TIP10W
25.0	2	MVX2500X2F25	●	2	50	57	77	127	25	32	0.6	SOX08	TPS351	TIP10W
	3	MVX2500X3F25	●	2	75	82	102	152	25	32	0.6	SOX08	TPS351	TIP10W
	4	MVX2500X4F25	●	2	100	107	127	177	25	32	0.6	SOX08	TPS351	TIP10W
	5	MVX2500X5F25	●	2	125	132	152	202	25	32	0.6	SOX08	TPS351	TIP10W
	6	MVX2500X6F25	●	2	150	157	177	227	25	32	0.6	SOX08	TPS351	TIP10W
25.5	2	MVX2550X2F25	●	2	51	58	78	128	25	32	0.6	SOX08	TPS351	TIP10W
	3	MVX2550X3F25	●	2	76.5	83.5	103.5	153.5	25	32	0.6	SOX08	TPS351	TIP10W
26.0	2	MVX2600X2F32	●	2	52	59	79	134	32	42	0.5	SOX08	TPS351	TIP10W
	3	MVX2600X3F32	●	2	78	85	105	160	32	42	0.5	SOX08	TPS351	TIP10W
	4	MVX2600X4F32	●	2	104	111	131	186	32	42	0.5	SOX08	TPS351	TIP10W
	5	MVX2600X5F32	●	2	130	137	157	212	32	42	0.5	SOX08	TPS351	TIP10W
	6	MVX2600X6F32	●	2	156	163	183	238	32	42	0.5	SOX08	TPS351	TIP10W
26.5	2	MVX2650X2F32	●	2	53	60	80	135	32	42	0.5	SOX08	TPS351	TIP10W
	3	MVX2650X3F32	●	2	79.5	86.5	106.5	161.5	32	42	0.5	SOX08	TPS351	TIP10W
27.0	2	MVX2700X2F32	●	2	54	61	81	136	32	42	0.45	SOX08	TPS351	TIP10W
	3	MVX2700X3F32	●	2	81	88	108	163	32	42	0.45	SOX08	TPS351	TIP10W
	4	MVX2700X4F32	●	2	108	115	135	190	32	42	0.45	SOX08	TPS351	TIP10W
	5	MVX2700X5F32	●	2	135	142	162	217	32	42	0.45	SOX08	TPS351	TIP10W
	6	MVX2700X6F32	●	2	162	169	189	244	32	42	0.45	SOX08	TPS351	TIP10W
27.5	2	MVX2750X2F32	●	2	55	62	82	137	32	42	0.4	SOX08	TPS351	TIP10W
	3	MVX2750X3F32	●	2	82.5	89.5	109.5	164.5	32	42	0.4	SOX08	TPS351	TIP10W
28.0	2	MVX2800X2F32	●	2	56	63	83	138	32	42	0.85	SOX09	TPS4	TIP15W
	3	MVX2800X3F32	●	2	84	91	111	166	32	42	0.85	SOX09	TPS4	TIP15W
	4	MVX2800X4F32	●	2	112	119	139	194	32	42	0.85	SOX09	TPS4	TIP15W
	5	MVX2800X5F32	●	2	140	147	167	222	32	42	0.85	SOX09	TPS4	TIP15W
	6	MVX2800X6F32	●	2	168	175	195	250	32	42	0.85	SOX09	TPS4	TIP15W
28.5	2	MVX2850X2F32	●	2	57	64	84	139	32	42	0.8	SOX09	TPS4	TIP15W
	3	MVX2850X3F32	●	2	85.5	92.5	112.5	167.5	32	42	0.8	SOX09	TPS4	TIP15W
29.0	2	MVX2900X2F32	●	2	58	65	85	140	32	42	0.75	SOX09	TPS4	TIP15W
	3	MVX2900X3F32	●	2	87	94	114	169	32	42	0.75	SOX09	TPS4	TIP15W
	4	MVX2900X4F32	●	2	116	123	143	198	32	42	0.75	SOX09	TPS4	TIP15W
	5	MVX2900X5F32	●	2	145	152	172	227	32	42	0.75	SOX09	TPS4	TIP15W
	6	MVX2900X6F32	●	2	174	181	201	256	32	42	0.75	SOX09	TPS4	TIP15W
29.5	2	MVX2950X2F32	●	2	59	66	86	141	32	42	0.7	SOX09	TPS4	TIP15W
	3	MVX2950X3F32	●	2	88.5	95.5	115.5	170.5	32	42	0.7	SOX09	TPS4	TIP15W

* Момент затяжки (N • м) : TPS351=2.5, TPS4=3.5

● : Есть на складе.

DC (мм)	Глубина отверстия (L/D)	Обозначение	Наличие зубья	Размеры (мм)						S10 (мм)	Insert				
				LU	LBX	LPR	OAL	DCON	DCSFMS					Винт	Ключ
30.0	2	MVX3000X2F32	●	2	60	67	87	142	32	42	0.65	SOX09	TPS4	TIP15W	
	3	MVX3000X3F32	●	2	90	97	117	172	32	42	0.65	SOX09	TPS4	TIP15W	
	4	MVX3000X4F32	●	2	120	127	147	202	32	42	0.65	SOX09	TPS4	TIP15W	
	5	MVX3000X5F32	●	2	150	157	177	232	32	42	0.65	SOX09	TPS4	TIP15W	
	6	MVX3000X6F32	●	2	180	187	207	262	32	42	0.65	SOX09	TPS4	TIP15W	
30.5	3	MVX3050X3F32	●	2	91.5	98.5	118.5	173.5	32	42	0.6	SOX09	TPS4	TIP15W	
31.0	2	MVX3100X2F32	●	2	62	69	89	144	32	42	0.55	SOX09	TPS4	TIP15W	
	3	MVX3100X3F32	●	2	93	100	120	175	32	42	0.55	SOX09	TPS4	TIP15W	
	4	MVX3100X4F32	●	2	124	131	151	206	32	42	0.55	SOX09	TPS4	TIP15W	
	2	MVX3100X2F40	●	2	62	69	89	154	40	50	0.55	SOX09	TPS4	TIP15W	
	3	MVX3100X3F40	●	2	93	100	120	185	40	50	0.55	SOX09	TPS4	TIP15W	
	4	MVX3100X4F40	●	2	124	131	151	216	40	50	0.55	SOX09	TPS4	TIP15W	
31.5	5	MVX3100X5F40	●	2	155	162	182	247	40	50	0.55	SOX09	TPS4	TIP15W	
	6	MVX3100X6F40	●	2	186	193	213	278	40	50	0.55	SOX09	TPS4	TIP15W	
	3	MVX3150X3F40	●	2	94.5	101.5	121.5	186.5	40	50	0.55	SOX09	TPS4	TIP15W	
	32.0	2	MVX3200X2F32	●	2	64	71	91	146	32	42	0.45	SOX09	TPS4	TIP15W
		3	MVX3200X3F32	●	2	96	103	123	178	32	42	0.45	SOX09	TPS4	TIP15W
		4	MVX3200X4F32	●	2	128	135	155	210	32	42	0.45	SOX09	TPS4	TIP15W
2		MVX3200X2F40	●	2	64	71	91	156	40	50	0.45	SOX09	TPS4	TIP15W	
3		MVX3200X3F40	●	2	96	103	123	188	40	50	0.45	SOX09	TPS4	TIP15W	
4		MVX3200X4F40	●	2	128	135	155	220	40	50	0.45	SOX09	TPS4	TIP15W	
32.5	5	MVX3200X5F40	●	2	160	167	187	252	40	50	0.45	SOX09	TPS4	TIP15W	
	6	MVX3200X6F40	●	2	192	199	219	284	40	50	0.45	SOX09	TPS4	TIP15W	
	3	MVX3250X3F40	●	2	97.5	104.5	124.5	189.5	40	50	0.45	SOX09	TPS4	TIP15W	
	33.0	2	MVX3300X2F32	●	2	66	73	93	148	32	42	0.4	SOX09	TPS4	TIP15W
		3	MVX3300X3F32	●	2	99	106	126	181	32	42	0.4	SOX09	TPS4	TIP15W
		4	MVX3300X4F32	●	2	132	139	159	214	32	42	0.4	SOX09	TPS4	TIP15W
2		MVX3300X2F40	●	2	66	73	93	158	40	50	0.4	SOX09	TPS4	TIP15W	
3		MVX3300X3F40	●	2	99	106	126	191	40	50	0.4	SOX09	TPS4	TIP15W	
4		MVX3300X4F40	●	2	132	139	159	224	40	50	0.4	SOX09	TPS4	TIP15W	
33.5	5	MVX3300X5F40	●	2	165	172	192	257	40	50	0.4	SOX09	TPS4	TIP15W	
	6	MVX3300X6F40	●	2	198	205	225	290	40	50	0.4	SOX09	TPS4	TIP15W	
	3	MVX3350X3F40	●	2	100.5	107.5	127.5	192.5	40	50	1.15	SOX11	TPS43	TIP15W	
	34.0	2	MVX3400X2F40	●	2	68	75	105	170	40	50	1.11	SOX11	TPS43	TIP15W
		3	MVX3400X3F40	●	2	102	109	139	204	40	50	1.11	SOX11	TPS43	TIP15W
		4	MVX3400X4F40	●	2	136	143	173	238	40	50	1.11	SOX11	TPS43	TIP15W
5		MVX3400X5F40	●	2	170	177	207	272	40	50	1.11	SOX11	TPS43	TIP15W	
6		MVX3400X6F40	●	2	204	211	241	306	40	50	1.1	SOX11	TPS43	TIP15W	
3		MVX3450X3F40	●	2	103.5	110.5	140.5	205.5	40	50	1.08	SOX11	TPS43	TIP15W	
35.0	2	MVX3500X2F40	●	2	70	77	107	172	40	50	1.03	SOX11	TPS43	TIP15W	
	3	MVX3500X3F40	●	2	105	112	142	207	40	50	1.03	SOX11	TPS43	TIP15W	
	4	MVX3500X4F40	●	2	140	147	177	242	40	50	1.03	SOX11	TPS43	TIP15W	
	5	MVX3500X5F40	●	2	175	182	212	277	40	50	1.03	SOX11	TPS43	TIP15W	
	6	MVX3500X6F40	●	2	210	217	247	312	40	50	1.02	SOX11	TPS43	TIP15W	
	3	MVX3550X3F40	●	2	106.5	113.5	143.5	208.5	40	50	0.99	SOX11	TPS43	TIP15W	
36.0	2	MVX3600X2F40	●	2	72	79	109	174	40	50	0.95	SOX11	TPS43	TIP15W	
	3	MVX3600X3F40	●	2	108	115	145	210	40	50	0.95	SOX11	TPS43	TIP15W	
	4	MVX3600X4F40	●	2	144	151	181	246	40	50	0.95	SOX11	TPS43	TIP15W	
	5	MVX3600X5F40	●	2	180	187	217	282	40	50	0.95	SOX11	TPS43	TIP15W	
	6	MVX3600X6F40	●	2	216	223	253	318	40	50	0.94	SOX11	TPS43	TIP15W	

* Момент затяжки (N • м) : TPS4=3.5, TPS43=3.5

ОПИСАНИЕ ПЛАСТИН > M168
РЕЖИМЫ РЕЗАНИЯ > M169
ТОЧНАЯ ПЕРЕХОДНАЯ ВТУЛКА > M172

РЕКОМЕНДАЦИИ > M173
ЗАПАСНЫЕ ЧАСТИ > N001
ТЕХНИЧЕСКИЕ ДАННЫЕ > P001



ИНСТРУМЕНТ ДЛЯ СВЕРЛЕНИЯ (СВЕРЛА СО СМЕННЫМИ ПЛАСТИНАМИ)

MVX

ТВЕРДЫЙ
СПЛАВ



M

ИНСТРУМЕНТ ДЛЯ
СВЕРЛЕНИЯ

DC (мм)	Глубина отверстия (L/D)	Обозначение	Наличие	Зубья	Размеры (мм)						S10 (мм)	Insert		
					LU	LBX	LPR	OAL	DCON	DCSFMS				
37.0	2	MVX3700X2F40	●	2	74	81	111	176	40	50	0.87	SOX11	TPS43	TIP15W
	3	MVX3700X3F40	●	2	111	118	148	213	40	50	0.87	SOX11	TPS43	TIP15W
	4	MVX3700X4F40	●	2	148	155	185	250	40	50	0.87	SOX11	TPS43	TIP15W
	5	MVX3700X5F40	●	2	185	192	222	287	40	50	0.87	SOX11	TPS43	TIP15W
	6	MVX3700X6F40	●	2	222	229	259	324	40	50	0.86	SOX11	TPS43	TIP15W
38.0	2	MVX3800X2F40	●	2	76	83	113	178	40	50	0.79	SOX11	TPS43	TIP15W
	3	MVX3800X3F40	●	2	114	121	151	216	40	50	0.79	SOX11	TPS43	TIP15W
	4	MVX3800X4F40	●	2	152	159	189	254	40	50	0.79	SOX11	TPS43	TIP15W
	5	MVX3800X5F40	●	2	190	197	227	292	40	50	0.79	SOX11	TPS43	TIP15W
	6	MVX3800X6F40	●	2	228	235	265	330	40	50	0.78	SOX11	TPS43	TIP15W
39.0	2	MVX3900X2F40	●	2	78	85	115	180	40	50	0.71	SOX11	TPS43	TIP15W
	3	MVX3900X3F40	●	2	117	124	154	219	40	50	0.71	SOX11	TPS43	TIP15W
	4	MVX3900X4F40	●	2	156	163	193	258	40	50	0.71	SOX11	TPS43	TIP15W
	5	MVX3900X5F40	●	2	195	202	232	297	40	50	0.71	SOX11	TPS43	TIP15W
	6	MVX3900X6F40	●	2	234	241	271	336	40	50	0.7	SOX11	TPS43	TIP15W
40.0	2	MVX4000X2F40	●	2	80	87	117	182	40	50	1.46	SOX13	TPS43	TIP15W
	3	MVX4000X3F40	●	2	120	127	157	222	40	50	1.46	SOX13	TPS43	TIP15W
	4	MVX4000X4F40	●	2	160	167	197	262	40	50	1.46	SOX13	TPS43	TIP15W
	5	MVX4000X5F40	●	2	200	207	237	302	40	50	1.46	SOX13	TPS43	TIP15W
	6	MVX4000X6F40	●	2	240	247	277	342	40	50	1.45	SOX13	TPS43	TIP15W
41.0	2	MVX4100X2F40	●	2	82	89	119	184	40	50	1.36	SOX13	TPS43	TIP15W
	3	MVX4100X3F40	●	2	123	130	160	225	40	50	1.36	SOX13	TPS43	TIP15W
	4	MVX4100X4F40	●	2	164	171	201	266	40	50	1.36	SOX13	TPS43	TIP15W
	5	MVX4100X5F40	●	2	205	212	242	307	40	50	1.36	SOX13	TPS43	TIP15W
	6	MVX4100X6F40	●	2	246	253	283	348	40	50	1.35	SOX13	TPS43	TIP15W
42.0	2	MVX4200X2F40	●	2	84	91	121	186	40	50	1.27	SOX13	TPS43	TIP15W
	3	MVX4200X3F40	●	2	126	133	163	228	40	50	1.27	SOX13	TPS43	TIP15W
	4	MVX4200X4F40	●	2	168	175	205	270	40	63	1.27	SOX13	TPS43	TIP15W
	5	MVX4200X5F40	●	2	210	217	247	312	40	63	1.27	SOX13	TPS43	TIP15W
	6	MVX4200X6F40	●	2	252	259	289	354	40	63	1.27	SOX13	TPS43	TIP15W
	4	MVX4200X4F50	★	2	168	175	205	280	50	63	1.27	SOX13	TPS43	TIP15W
	5	MVX4200X5F50	★	2	210	217	247	322	50	63	1.27	SOX13	TPS43	TIP15W
6	MVX4200X6F50	★	2	252	259	289	364	50	63	1.26	SOX13	TPS43	TIP15W	
43.0	2	MVX4300X2F40	●	2	86	93	123	188	40	50	1.18	SOX13	TPS43	TIP15W
	3	MVX4300X3F40	●	2	129	136	166	231	40	50	1.18	SOX13	TPS43	TIP15W
	4	MVX4300X4F40	●	2	172	179	209	274	40	63	1.18	SOX13	TPS43	TIP15W
	5	MVX4300X5F40	●	2	215	222	252	317	40	63	1.18	SOX13	TPS43	TIP15W
	6	MVX4300X6F40	●	2	258	265	295	360	40	63	1.17	SOX13	TPS43	TIP15W
	4	MVX4300X4F50	★	2	172	179	209	284	50	63	1.18	SOX13	TPS43	TIP15W
	5	MVX4300X5F50	★	2	215	222	252	327	50	63	1.18	SOX13	TPS43	TIP15W
6	MVX4300X6F50	★	2	258	265	295	370	50	63	1.17	SOX13	TPS43	TIP15W	
44.0	2	MVX4400X2F40	●	2	88	95	125	190	40	50	1.08	SOX13	TPS43	TIP15W
	3	MVX4400X3F40	●	2	132	139	169	234	40	50	1.08	SOX13	TPS43	TIP15W
	4	MVX4400X4F40	●	2	176	183	213	278	40	63	1.08	SOX13	TPS43	TIP15W
	5	MVX4400X5F40	●	2	220	227	257	322	40	63	1.08	SOX13	TPS43	TIP15W
	4	MVX4400X4F50	★	2	176	183	213	288	50	63	1.08	SOX13	TPS43	TIP15W
5	MVX4400X5F50	★	2	220	227	257	332	50	63	1.08	SOX13	TPS43	TIP15W	

* Момент затяжки (N · м) : TPS43=3.5

● : Есть на складе. ★ : Со склада в Японии.

DC (мм)	Глубина отверстия (L/D)	Обозначение	Наличие зубья	Размеры (мм)						S10 (мм)	Insert			
				LU	LBX	LPR	OAL	DCON	DCSFMS					Винт
45.0	2	MVX4500X2F40	●	2	90	97	127	192	40	50	0.99	SOX13	TPS43	TIP15W
	3	MVX4500X3F40	●	2	135	142	172	237	40	50	0.99	SOX13	TPS43	TIP15W
	4	MVX4500X4F40	●	2	180	187	217	282	40	63	0.99	SOX13	TPS43	TIP15W
	5	MVX4500X5F40	●	2	225	232	262	327	40	63	0.99	SOX13	TPS43	TIP15W
	4	MVX4500X4F50	★	2	180	187	217	292	50	63	0.99	SOX13	TPS43	TIP15W
	5	MVX4500X5F50	★	2	225	232	262	337	50	63	0.99	SOX13	TPS43	TIP15W
46.0	2	MVX4600X2F40	●	2	92	99	129	194	40	50	0.89	SOX13	TPS43	TIP15W
	3	MVX4600X3F40	●	2	138	145	175	240	40	50	0.89	SOX13	TPS43	TIP15W
	4	MVX4600X4F40	●	2	184	191	221	286	40	63	0.89	SOX13	TPS43	TIP15W
	5	MVX4600X5F40	●	2	230	237	267	332	40	63	0.89	SOX13	TPS43	TIP15W
	4	MVX4600X4F50	★	2	184	191	221	296	50	63	0.89	SOX13	TPS43	TIP15W
	5	MVX4600X5F50	★	2	230	237	267	342	50	63	0.89	SOX13	TPS43	TIP15W
47.0	2	MVX4700X2F40	●	2	94	101	141	206	40	63	1.9	SOX16	TPS54	TIP25D
	3	MVX4700X3F40	●	2	141	148	188	253	40	63	1.9	SOX16	TPS54	TIP25D
	4	MVX4700X4F40	●	2	188	195	235	300	40	63	1.9	SOX16	TPS54	TIP25D
	5	MVX4700X5F40	●	2	235	242	282	347	40	63	1.9	SOX16	TPS54	TIP25D
	4	MVX4700X4F50	★	2	188	195	235	310	50	63	1.9	SOX16	TPS54	TIP25D
	5	MVX4700X5F50	★	2	235	242	282	357	50	63	1.9	SOX16	TPS54	TIP25D
48.0	2	MVX4800X2F40	●	2	96	103	143	208	40	63	1.8	SOX16	TPS54	TIP25D
	3	MVX4800X3F40	●	2	144	151	191	256	40	63	1.8	SOX16	TPS54	TIP25D
	4	MVX4800X4F40	●	2	192	199	239	304	40	63	1.8	SOX16	TPS54	TIP25D
	5	MVX4800X5F40	●	2	240	247	287	352	40	63	1.8	SOX16	TPS54	TIP25D
	4	MVX4800X4F50	★	2	192	199	239	314	50	63	1.8	SOX16	TPS54	TIP25D
	5	MVX4800X5F50	★	2	240	247	287	362	50	63	1.8	SOX16	TPS54	TIP25D
49.0	2	MVX4900X2F40	●	2	98	105	145	210	40	63	1.7	SOX16	TPS54	TIP25D
	3	MVX4900X3F40	●	2	147	154	194	259	40	63	1.7	SOX16	TPS54	TIP25D
	4	MVX4900X4F40	●	2	196	203	243	308	40	63	1.7	SOX16	TPS54	TIP25D
	5	MVX4900X5F40	●	2	245	252	292	357	40	63	1.7	SOX16	TPS54	TIP25D
	4	MVX4900X4F50	★	2	196	203	243	318	50	63	1.7	SOX16	TPS54	TIP25D
	5	MVX4900X5F50	★	2	245	252	292	367	50	63	1.7	SOX16	TPS54	TIP25D
50.0	2	MVX5000X2F40	●	2	100	107	147	212	40	63	1.6	SOX16	TPS54	TIP25D
	3	MVX5000X3F40	●	2	150	157	197	262	40	63	1.6	SOX16	TPS54	TIP25D
	4	MVX5000X4F40	●	2	200	207	247	312	40	63	1.6	SOX16	TPS54	TIP25D
	5	MVX5000X5F40	●	2	250	257	297	362	40	63	1.6	SOX16	TPS54	TIP25D
	4	MVX5000X4F50	★	2	200	207	247	322	50	63	1.6	SOX16	TPS54	TIP25D
	5	MVX5000X5F50	★	2	250	257	297	372	50	63	1.6	SOX16	TPS54	TIP25D
51.0	2	MVX5100X2F40	●	2	102	109	149	214	40	63	1.5	SOX16	TPS54	TIP25D
	3	MVX5100X3F40	●	2	153	160	200	265	40	63	1.5	SOX16	TPS54	TIP25D
	4	MVX5100X4F40	●	2	204	211	251	316	40	63	1.5	SOX16	TPS54	TIP25D
	5	MVX5100X5F40	●	2	255	262	302	367	40	63	1.5	SOX16	TPS54	TIP25D
	4	MVX5100X4F50	★	2	204	211	251	326	50	63	1.5	SOX16	TPS54	TIP25D
	5	MVX5100X5F50	★	2	255	262	302	377	50	63	1.5	SOX16	TPS54	TIP25D
52.0	2	MVX5200X2F40	●	2	104	111	151	216	40	63	1.39	SOX16	TPS54	TIP25D
	3	MVX5200X3F40	●	2	156	163	203	268	40	63	1.39	SOX16	TPS54	TIP25D
	4	MVX5200X4F40	●	2	208	215	255	320	40	63	1.39	SOX16	TPS54	TIP25D
	5	MVX5200X5F40	●	2	260	267	307	372	40	63	1.39	SOX16	TPS54	TIP25D
	4	MVX5200X4F50	★	2	208	215	255	330	50	63	1.39	SOX16	TPS54	TIP25D
	5	MVX5200X5F50	★	2	260	267	307	382	50	63	1.39	SOX16	TPS54	TIP25D

* Момент затяжки (N • м) : TPS43=3.5, TPS54=7.5



ИНСТРУМЕНТ ДЛЯ СВЕРЛЕНИЯ (СВЕРЛА СО СМЕННЫМИ ПЛАСТИНАМИ)

MVX

ТВЕРДЫЙ
СПЛАВ



M

ИНСТРУМЕНТ ДЛЯ
СВЕРЛЕНИЯ

DC (мм)	Глубина отверстия (L/D)	Обозначение	Наличие	Зубья	Размеры (мм)						S10 (мм)	Insert		
					LU	LBX	LPR	OAL	DCON	DCSFMS				
53.0	2	MVX5300X2F40	●	2	106	113	153	218	40	63	1.29	SOX16	TPS54	TIP25D
	3	MVX5300X3F40	●	2	159	166	206	271	40	63	1.29	SOX16	TPS54	TIP25D
	4	MVX5300X4F40	●	2	212	219	259	324	40	63	1.29	SOX16	TPS54	TIP25D
	5	MVX5300X5F40	●	2	265	272	312	377	40	63	1.29	SOX16	TPS54	TIP25D
	4	MVX5300X4F50	★	2	212	219	259	334	50	63	1.29	SOX16	TPS54	TIP25D
	5	MVX5300X5F50	★	2	265	272	312	387	50	63	1.29	SOX16	TPS54	TIP25D
54.0	2	MVX5400X2F40	●	2	108	115	155	220	40	63	1.19	SOX16	TPS54	TIP25D
	3	MVX5400X3F40	●	2	162	169	209	274	40	63	1.19	SOX16	TPS54	TIP25D
	4	MVX5400X4F40	●	2	216	223	263	328	40	63	1.19	SOX16	TPS54	TIP25D
	5	MVX5400X5F40	●	2	270	277	317	382	40	63	1.19	SOX16	TPS54	TIP25D
	4	MVX5400X4F50	★	2	216	223	263	338	50	63	1.19	SOX16	TPS54	TIP25D
	5	MVX5400X5F50	★	2	270	277	317	392	50	63	1.19	SOX16	TPS54	TIP25D
55.0	2	MVX5500X2F40	●	2	110	117	157	222	40	63	1.08	SOX16	TPS54	TIP25D
	3	MVX5500X3F40	●	2	165	172	212	277	40	63	1.08	SOX16	TPS54	TIP25D
	4	MVX5500X4F40	●	2	220	227	267	332	40	63	1.08	SOX16	TPS54	TIP25D
	5	MVX5500X5F40	●	2	275	282	322	387	40	63	1.08	SOX16	TPS54	TIP25D
	4	MVX5500X4F50	★	2	220	227	267	342	50	63	1.08	SOX16	TPS54	TIP25D
	5	MVX5500X5F50	●	2	275	282	322	397	50	63	1.08	SOX16	TPS54	TIP25D
56.0	2	MVX5600X2F40	●	2	112	119	159	224	40	63	0.98	SOX16	TPS54	TIP25D
	3	MVX5600X3F40	●	2	168	175	215	280	40	63	0.98	SOX16	TPS54	TIP25D
	4	MVX5600X4F40	●	2	224	231	271	336	40	63	0.98	SOX16	TPS54	TIP25D
	5	MVX5600X5F40	●	2	280	287	327	392	40	63	0.98	SOX16	TPS54	TIP25D
	4	MVX5600X4F50	★	2	224	231	271	346	50	63	0.98	SOX16	TPS54	TIP25D
	5	MVX5600X5F50	★	2	280	287	327	402	50	63	0.98	SOX16	TPS54	TIP25D
57.0	2	MVX5700X2F40	●	2	114	121	161	226	40	68	1.47	SOX18	TPS54	TIP25D
	3	MVX5700X3F40	●	2	171	178	218	283	40	68	1.47	SOX18	TPS54	TIP25D
	4	MVX5700X4F40	●	2	228	235	275	340	40	68	1.47	SOX18	TPS54	TIP25D
	5	MVX5700X5F40	●	2	285	292	332	397	40	68	1.47	SOX18	TPS54	TIP25D
	4	MVX5700X4F50	★	2	228	235	275	350	50	68	1.47	SOX18	TPS54	TIP25D
	5	MVX5700X5F50	★	2	285	292	332	407	50	68	1.47	SOX18	TPS54	TIP25D
58.0	2	MVX5800X2F40	●	2	116	123	163	228	40	68	1.37	SOX18	TPS54	TIP25D
	3	MVX5800X3F40	●	2	174	181	221	286	40	68	1.37	SOX18	TPS54	TIP25D
	4	MVX5800X4F40	●	2	232	239	279	344	40	68	1.37	SOX18	TPS54	TIP25D
	5	MVX5800X5F40	●	2	290	297	337	402	40	68	1.37	SOX18	TPS54	TIP25D
	4	MVX5800X4F50	★	2	232	239	279	354	50	68	1.37	SOX18	TPS54	TIP25D
	5	MVX5800X5F50	★	2	290	297	337	412	50	68	1.37	SOX18	TPS54	TIP25D
59.0	2	MVX5900X2F40	●	2	118	125	165	230	40	68	1.26	SOX18	TPS54	TIP25D
	3	MVX5900X3F40	●	2	177	184	224	289	40	68	1.26	SOX18	TPS54	TIP25D
	4	MVX5900X4F40	●	2	236	243	283	348	40	68	1.26	SOX18	TPS54	TIP25D
	5	MVX5900X5F40	●	2	295	302	342	407	40	68	1.26	SOX18	TPS54	TIP25D
	4	MVX5900X4F50	★	2	236	243	283	358	50	68	1.26	SOX18	TPS54	TIP25D
	5	MVX5900X5F50	★	2	295	302	342	417	50	68	1.26	SOX18	TPS54	TIP25D
60.0	2	MVX6000X2F40	●	2	120	127	167	232	40	68	1.16	SOX18	TPS54	TIP25D
	3	MVX6000X3F40	●	2	180	187	227	292	40	68	1.16	SOX18	TPS54	TIP25D
	4	MVX6000X4F40	●	2	240	247	287	352	40	68	1.16	SOX18	TPS54	TIP25D
	5	MVX6000X5F40	●	2	300	307	347	412	40	68	1.16	SOX18	TPS54	TIP25D
	4	MVX6000X4F50	★	2	240	247	287	362	50	68	1.16	SOX18	TPS54	TIP25D
	5	MVX6000X5F50	★	2	300	307	347	422	50	68	1.16	SOX18	TPS54	TIP25D

* Момент затяжки (N • м) : TPS54=7.5

● : Есть на складе. ★ : Со склада в Японии.

DC (мм)	Глубина отверстия (L/D)	Обозначение	Наличие	Зубья	Размеры (мм)						S10 (мм)	Insert		D 
					LU	LBX	LPR	OAL	DCON	DCSFMS				
61.0	2	MVX6100X2F40	●	2	122	129	169	234	40	68	1.05	SOX18	TPS54	TIP25D
	3	MVX6100X3F40	●	2	183	190	230	295	40	68	1.05	SOX18	TPS54	TIP25D
	4	MVX6100X4F40	●	2	244	251	291	356	40	68	1.05	SOX18	TPS54	TIP25D
	5	MVX6100X5F40	●	2	305	312	352	417	40	68	1.05	SOX18	TPS54	TIP25D
	4	MVX6100X4F50	★	2	244	251	291	366	50	68	1.05	SOX18	TPS54	TIP25D
	5	MVX6100X5F50	★	2	305	312	352	427	50	68	1.05	SOX18	TPS54	TIP25D
62.0	2	MVX6200X2F40	●	2	124	131	171	236	40	68	0.95	SOX18	TPS54	TIP25D
	3	MVX6200X3F40	●	2	186	193	233	298	40	68	0.95	SOX18	TPS54	TIP25D
	4	MVX6200X4F40	●	2	248	255	295	360	40	68	0.95	SOX18	TPS54	TIP25D
	5	MVX6200X5F40	●	2	310	317	357	422	40	68	0.95	SOX18	TPS54	TIP25D
	4	MVX6200X4F50	★	2	248	255	295	370	50	68	0.95	SOX18	TPS54	TIP25D
	5	MVX6200X5F50	★	2	310	317	357	432	50	68	0.95	SOX18	TPS54	TIP25D
63.0	2	MVX6300X2F40	●	2	126	133	173	238	40	68	0.85	SOX18	TPS54	TIP25D
	3	MVX6300X3F40	●	2	189	196	236	301	40	68	0.85	SOX18	TPS54	TIP25D
	4	MVX6300X4F40	●	2	252	259	299	364	40	68	0.85	SOX18	TPS54	TIP25D
	5	MVX6300X5F40	●	2	315	322	362	427	40	68	0.85	SOX18	TPS54	TIP25D
	4	MVX6300X4F50	★	2	252	259	299	374	50	68	0.85	SOX18	TPS54	TIP25D
	5	MVX6300X5F50	★	2	315	322	362	437	50	68	0.85	SOX18	TPS54	TIP25D

* Момент затяжки (N • м) : TPS54=7.5

M









ИНСТРУМЕНТ ДЛЯ
СВЕРЛЕНИЯ

ИНСТРУМЕНТ ДЛЯ СВЕРЛЕНИЯ (СВЕРЛА СО СМЕННЫМИ ПЛАСТИНАМИ)

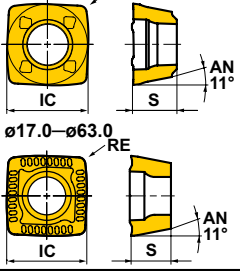
MVX

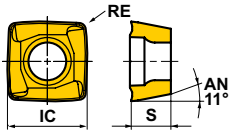

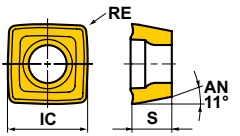

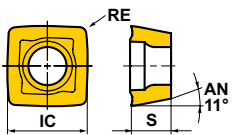







ТВЕРДЫЙ СПЛАВ

ПЛАСТИНЫ

Стружколом	Диаметр сверления	Номер пластины	Размеры (мм)			С покрытием				Твёрдый сплав		Геометрия
			IC	S	RE	VP15TF	MC1020	MC5020	DP8020	TF15		
  Для общего применения (для внутренней и внешней режущей кромки)	UM	NEW SOMX052704-UM	5.0	2.7	0.4	●	●	●				
		SOMX063005-UM	6.0	3.0	0.5	●	●	●				
		SOMX073505-UM	7.0	3.5	0.5	●	●	●				
		SOMX084005-UM	8.3	4.0	0.5	●	●	●				
		SOMX094506-UM	9.7	4.5	0.6	●	●	●				
		SOMX115506-UM	11.6	5.5	0.6	●	●	●				
		SOMX136008-UM	13.8	6.0	0.8	●	●	●				
		SOMX166508-UM	16.5	6.5	0.8	●	●	●				
	SOMX187008-UM	18.2	7.0	0.8	●	●	●					
 Для нержавеющей стали и внутренней кромки	US	SOMX063005-US	6.0	3.0	0.5	●						
		SOMX073505-US	7.0	3.5	0.5	●						
		SOMX084005-US	8.0	4.0	0.5	●						
		SOMX094506-US	9.0	4.5	0.6	●						
		SOMX115506-US	11.6	5.5	0.6	●						
		SOMX136008-US	13.8	6.0	0.8	●						
		SOMX166508-US	16.5	6.5	0.8	●						
	SOMX187008-US	18.2	7.0	0.8	●							
 Тип с прочной режущей кромкой (для внутренней режущей кромки)	UH	SOMX062905-UH	6.0	2.9	0.5				●			
		SOMX073405-UH	7.0	3.4	0.5				●			
		SOMX083905-UH	8.3	3.9	0.5				●			
		SOMX094406-UH	9.7	4.4	0.6				●			
		SOMX115406-UH	11.6	5.4	0.6				●			
		SOMX135908-UH	13.8	5.9	0.8				●			
		SOMX166408-UH	16.5	6.4	0.8				●			
	SOMX186908-UH	18.2	6.9	0.8				●				
 Для алюминиевых сплавов (для внутренней и внешней режущей кромки)	UN	SOGX063005-UN	6.0	3.0	0.5					●		
		SOGX073505-UN	7.0	3.5	0.5					●		
		SOGX084005-UN	8.3	4.0	0.5					●		
		SOGX094506-UN	9.7	4.5	0.6					●		
		SOGX115506-UN	11.6	5.5	0.6					●		
		SOGX136008-UN	13.8	6.0	0.8					●		
		SOGX166508-UN	16.5	6.5	0.8					●		
	SOGX187008-UN	18.2	7.0	0.8					●			

Примечание 1) MC1020 и MC5020 предназначены исключительно для использования в качестве внешней пластины. DP8020 предназначены исключительно для использования в качестве внутренней пластины.

РЕКОМЕНДАЦИИ ПО ПРИМЕНЕНИЮ ПЛАСТИН

	1-я рекомендация		При поломке внешней пластины	
	Внешняя пластина	Внутренняя пластина	Внешняя пластина	Внутренняя пластина
P Никотитовая сталь, легированная сталь	MC1020 	VP15TF 	VP15TF 	VP15TF 
	Стружколом UM	Стружколом UM	Стружколом UM	Стружколом UM
M Нержавеющая сталь	MC1020 	VP15TF 	VP15TF 	VP15TF 
	Стружколом UM	Стружколом US	Стружколом UM	Стружколом US
K Чугун	MC5020 	VP15TF 	VP15TF 	VP15TF 
	Стружколом UM	Стружколом UM	Стружколом UM	Стружколом UM

	1-я рекомендация		При поломке внешней пластины	
	Внешняя пластина	Внутренняя пластина	Внешняя пластина	Внутренняя пластина
H Закаленная сталь	MC1020 	DP8020 	VP15TF 	DP8020 
	Стружколом UM	Стружколом UH	Стружколом UM	Стружколом UH
N Алюминиевые сплавы	TF15 	TF15 		
	Стружколом UN	Стружколом UN		

РЕКОМЕНДУЕМЫЕ РЕЖИМЫ РЕЗАНИЯ

Обрабатываемый материал	Твердость	Vc (м/мин)	Внутр. стружколом	φ14—φ16.5			
				fr (мм/об)			
				L/D=2, 3	4	5	
P	Низкоуглеродистая сталь (C15, Ck15)	≤180HB	200 (180—235)	UM	0.05 (0.04—0.06)	0.05 (0.04—0.06)	0.05 (0.04—0.06)
				UH	—	—	—
	Углеродистая сталь, Легированная сталь (Ck45, 41CrMo4)	180—280HB	140 (115—180)	UM	0.08 (0.06—0.14)	0.08 (0.06—0.09)	0.08 (0.06—0.09)
				UH	—	—	—
	Углеродистая сталь, Легированная сталь (100Cr6)	280—350HB	100 (75—140)	UM	0.08 (0.06—0.14)	0.08 (0.06—0.09)	0.08 (0.06—0.09)
				UH	—	—	—
	Легированная инструментальная сталь (X210Cr12)	≤350HB	135 (100—170)	UM	0.08 (0.06—0.14)	0.08 (0.06—0.09)	0.08 (0.06—0.09)
				UH	—	—	—
M	Нержавеющая аустенитная сталь (X5CrNi18-10, X5CrNiMo17-12-2)	≤200HB	130 (80—180)	US	—	—	—
				UM	0.06 (0.04—0.08)	0.05 (0.04—0.06)	0.05 (0.04—0.06)
	Нержавеющая аустенитная сталь (X2CrNi18-9, X5CrNiMoN17-11-2)	>200HB	130 (80—180)	US	—	—	—
				UM	0.06 (0.04—0.08)	0.05 (0.04—0.06)	0.05 (0.04—0.06)
	Ферритная и мартенситная нержавеющая сталь (X12Cr13, X6Cr17)	≤200HB	120 (80—165)	US	—	—	—
				UM	0.06 (0.04—0.08)	0.05 (0.04—0.06)	0.05 (0.04—0.06)
	Ферритная и мартенситная нержавеющая сталь (X17CrNi16-2, X30Cr13)	>200HB	120 (80—165)	US	—	—	—
				UM	0.06 (0.04—0.08)	0.05 (0.04—0.06)	0.05 (0.04—0.06)
K	Чугун (GG25, GG30)	≤350МПа	160 (130—195)	UM	0.10 (0.06—0.14)	0.08 (0.06—0.10)	0.08 (0.06—0.10)
	Ковкий чугун (GG40)	≤450МПа	100 (80—135)	UM	0.10 (0.06—0.14)	0.08 (0.06—0.10)	0.08 (0.06—0.10)
	Ковкий чугун (GGG70)	≤800HB	100 (70—125)	UM	0.08 (0.06—0.12)	0.07 (0.06—0.08)	0.07 (0.06—0.08)
N	Алюминиевый сплав (A6061, A7075)	Si<5%	200 (100-350)	UN	—	—	—
	Алюминиевый сплав (AC4B)	5%≤Si≤10%	150 (100-200)	UN	—	—	—
	Алюминиевый сплав (ADC12, A390)	Si>10%	150 (100-200)	UN	—	—	—
H	Закаленная сталь (X40CrMoV51, 55NiCrMoV6)	38 - 45HRC	50 (30-80)	UH	—	—	—

Примечание 1) Уменьшите скорость резания на 30% при использовании VP15TF в качестве внешней пластины.

Примечание 2) L/D=3 — рекомендованная максимальная глубина резания при использовании только наружной подачи СОЖ.

Примечание 3) Внутренняя подача СОЖ необходима при сверлении нержавеющей стали.

РЕКОМЕНДАЦИИ > M173
 ЗАПАСНЫЕ ЧАСТИ > N001
 ТЕХНИЧЕСКИЕ ДАННЫЕ > P001

ИНСТРУМЕНТ ДЛЯ СВЕРЛЕНИЯ (СВЕРЛА СО СМЕННЫМИ ПЛАСТИНАМИ)

MVX

ТВЕРДЫЙ
СПЛАВ

РЕКОМЕНДУЕМЫЕ РЕЖИМЫ РЕЗАНИЯ

Обрабатываемый материал	Твердость	Vc (м/мин)	Внутр. стружколом	φ17—φ19.5					
				fr (мм/об)					
				L/D=2, 3	4	5	6		
P	Низкоуглеродистая сталь (C15, Ck15)	≤180HB	200 (180—235)	UM	0.05 (0.04—0.06)	0.05 (0.04—0.06)	0.05 (0.04—0.06)	0.04 (0.04—0.05)	
			UH						
	Углеродистая сталь, Легированная сталь (Ck45, 41CrMo4)	180—280HB	140 (115—180)	UM	0.08 (0.06—0.14)	0.08 (0.06—0.09)	0.08 (0.06—0.09)	0.05 (0.04—0.06)	
				UH					
	Углеродистая сталь, Легированная сталь (100Cr6)	280—350HB	100 (75—140)	UM	0.08 (0.06—0.14)	0.08 (0.06—0.09)	0.08 (0.06—0.09)	0.05 (0.04—0.06)	
				UH					
	Легированная инструментальная сталь (X210Cr12)	≤350HB	135 (100—170)	UM	0.08 (0.06—0.14)	0.08 (0.06—0.09)	0.08 (0.06—0.09)	0.05 (0.04—0.06)	
				UH					
M	Нержавеющая аустенитная сталь (X5CrNi18-10, X5CrNiMo17-12-2)	≤200HB	130 (80—180)	US	0.08 (0.06—0.12)	0.06 (0.04—0.08)	0.06 (0.04—0.08)	0.05 (0.04—0.06)	
			UM	0.06 (0.04—0.08)	0.05 (0.04—0.06)	0.05 (0.04—0.06)	0.04 (0.04—0.05)		
	Нержавеющая аустенитная сталь (X2CrNiN18-9, X5CrNiMoN17-11-2)	>200HB	130 (80—180)	US	0.08 (0.06—0.12)	0.06 (0.04—0.08)	0.06 (0.04—0.08)	0.05 (0.04—0.06)	
				UM	0.06 (0.04—0.08)	0.05 (0.04—0.06)	0.05 (0.04—0.06)	0.04 (0.04—0.05)	
	Ферритная и мартенситная нержавеющая сталь (X12Cr13, X6Cr17)	≤200HB	120 (80—165)	US	0.08 (0.06—0.12)	0.06 (0.04—0.08)	0.06 (0.04—0.08)	0.05 (0.04—0.06)	
				UM	0.06 (0.04—0.08)	0.05 (0.04—0.06)	0.05 (0.04—0.06)	0.04 (0.04—0.05)	
	Ферритная и мартенситная нержавеющая сталь (X17CrNi16-2, X30Cr13)	>200HB	120 (80—165)	US	0.08 (0.06—0.12)	0.06 (0.04—0.08)	0.06 (0.04—0.08)	0.05 (0.04—0.06)	
				UM	0.06 (0.04—0.08)	0.05 (0.04—0.06)	0.05 (0.04—0.06)	0.04 (0.04—0.05)	
	K	Чугун (GG25, GG30)	≤350МПа	160 (130—195)	UM	0.11 (0.08—0.14)	0.09 (0.08—0.10)	0.09 (0.08—0.10)	0.05 (0.04—0.06)
		Ковкий чугун (GG40)	≤450МПа	100 (80—135)	UM	0.11 (0.08—0.14)	0.09 (0.08—0.10)	0.09 (0.08—0.10)	0.05 (0.04—0.06)
Ковкий чугун (GGG70)		≤800HB	100 (70—125)	UM	0.11 (0.08—0.14)	0.09 (0.08—0.10)	0.09 (0.08—0.10)	0.05 (0.04—0.06)	
N	Алюминиевый сплав (A6061, A7075)	Si<5%	200 (100-350)	UN	0.12 (0.05—0.18)	0.12 (0.05—0.18)	0.12 (0.05—0.18)	0.08 (0.05—0.12)	
	Алюминиевый сплав (AC4B)	5%≤Si≤10%	150 (100-200)	UN	0.12 (0.05—0.18)	0.12 (0.05—0.18)	0.12 (0.05—0.18)	0.08 (0.05—0.12)	
	Алюминиевый сплав (ADC12, A390)	Si>10%	150 (100-200)	UN	0.12 (0.05—0.18)	0.12 (0.05—0.18)	0.12 (0.05—0.18)	0.08 (0.05—0.12)	
H	Закаленная сталь (X40CrMoV51, 55NiCrMoV6)	38 - 45HRC	50 (30-80)	UH	0.08 (0.04—0.12)	0.06 (0.04—0.09)	—	—	

Примечание 1) Уменьшите скорость резания на 30% при использовании VP15TF в качестве внешней пластины.

Примечание 2) L/D=3 — рекомендованная максимальная глубина резания при использовании только наружной подачи СОЖ.

Примечание 3) Внутренняя подача СОЖ необходима при сверлении нержавеющей стали.

	φ20—φ23.5				φ24—φ29.5				φ30—φ63			
	fr (мм/об)				fr (мм/об)				fr (мм/об)			
	L/D=2, 3	4	5	6	L/D=2, 3	4	5	6	L/D=2, 3	4	5	6
	0.06 (0.04—0.08)	0.06 (0.04—0.07)	0.06 (0.04—0.07)	0.04 (0.04—0.05)	0.07 (0.04—0.08)	0.06 (0.04—0.07)	0.06 (0.04—0.07)	0.05 (0.04—0.06)	0.08 (0.06—0.10)	0.07 (0.06—0.08)	0.07 (0.06—0.08)	0.06 (0.06—0.07)
	0.10 (0.06—0.18)	0.09 (0.06—0.12)	0.09 (0.06—0.12)	0.07 (0.06—0.08)	0.12 (0.08—0.18)	0.10 (0.08—0.12)	0.10 (0.08—0.12)	0.09 (0.08—0.10)	0.14 (0.08—0.20)	0.12 (0.08—0.16)	0.12 (0.08—0.16)	0.11 (0.10—0.12)
	0.10 (0.06—0.18)	0.09 (0.06—0.12)	0.09 (0.06—0.12)	0.07 (0.06—0.08)	0.12 (0.08—0.18)	0.10 (0.08—0.12)	0.10 (0.08—0.12)	0.09 (0.08—0.10)	0.14 (0.08—0.20)	0.12 (0.08—0.16)	0.12 (0.08—0.16)	0.11 (0.10—0.12)
	0.10 (0.06—0.18)	0.09 (0.06—0.12)	0.09 (0.06—0.12)	0.07 (0.06—0.08)	0.12 (0.08—0.18)	0.10 (0.08—0.12)	0.10 (0.08—0.12)	0.09 (0.08—0.10)	0.14 (0.08—0.20)	0.12 (0.08—0.16)	0.12 (0.08—0.16)	0.10 (0.08—0.12)
	0.10 (0.06—0.14)	0.07 (0.06—0.08)	0.07 (0.06—0.08)	0.06 (0.06—0.07)	0.10 (0.06—0.14)	0.08 (0.06—0.10)	0.08 (0.06—0.10)	0.07 (0.06—0.08)	0.10 (0.06—0.14)	0.09 (0.06—0.12)	0.09 (0.06—0.12)	0.07 (0.06—0.10)
	0.08 (0.06—0.12)	0.07 (0.06—0.08)	0.07 (0.06—0.08)	0.06 (0.06—0.07)	0.09 (0.06—0.12)	0.07 (0.06—0.09)	0.07 (0.06—0.09)	0.06 (0.06—0.08)	0.09 (0.06—0.12)	0.08 (0.06—0.10)	0.08 (0.06—0.10)	0.07 (0.06—0.08)
	0.10 (0.06—0.14)	0.07 (0.06—0.08)	0.07 (0.06—0.08)	0.06 (0.06—0.07)	0.10 (0.06—0.14)	0.08 (0.06—0.10)	0.08 (0.06—0.10)	0.07 (0.06—0.08)	0.10 (0.06—0.14)	0.09 (0.06—0.12)	0.09 (0.06—0.12)	0.07 (0.06—0.10)
	0.08 (0.06—0.12)	0.07 (0.06—0.08)	0.07 (0.06—0.08)	0.06 (0.06—0.07)	0.09 (0.06—0.12)	0.07 (0.06—0.09)	0.07 (0.06—0.09)	0.06 (0.06—0.08)	0.09 (0.06—0.12)	0.08 (0.06—0.10)	0.08 (0.06—0.10)	0.07 (0.06—0.08)
	0.10 (0.06—0.14)	0.07 (0.06—0.08)	0.07 (0.06—0.08)	0.06 (0.06—0.07)	0.10 (0.06—0.14)	0.08 (0.06—0.10)	0.08 (0.06—0.10)	0.07 (0.06—0.08)	0.10 (0.06—0.14)	0.09 (0.06—0.12)	0.09 (0.06—0.12)	0.07 (0.06—0.10)
	0.08 (0.06—0.12)	0.07 (0.06—0.08)	0.07 (0.06—0.08)	0.06 (0.06—0.07)	0.09 (0.06—0.12)	0.07 (0.06—0.09)	0.07 (0.06—0.09)	0.06 (0.06—0.08)	0.09 (0.06—0.12)	0.08 (0.06—0.10)	0.08 (0.06—0.10)	0.07 (0.06—0.08)
	0.14 (0.10—0.18)	0.10 (0.10—0.12)	0.10 (0.10—0.12)	0.07 (0.06—0.08)	0.15 (0.10—0.20)	0.11 (0.10—0.13)	0.11 (0.10—0.13)	0.09 (0.08—0.10)	0.15 (0.10—0.20)	0.12 (0.10—0.13)	0.12 (0.10—0.13)	0.11 (0.10—0.12)
	0.13 (0.10—0.16)	0.10 (0.10—0.11)	0.10 (0.10—0.11)	0.07 (0.06—0.08)	0.14 (0.10—0.18)	0.11 (0.10—0.12)	0.11 (0.10—0.12)	0.09 (0.08—0.10)	0.15 (0.10—0.20)	0.12 (0.10—0.13)	0.12 (0.10—0.13)	0.11 (0.10—0.12)
	0.13 (0.10—0.16)	0.10 (0.10—0.11)	0.10 (0.10—0.11)	0.07 (0.06—0.08)	0.14 (0.10—0.18)	0.11 (0.10—0.12)	0.11 (0.10—0.12)	0.09 (0.08—0.10)	0.15 (0.10—0.20)	0.12 (0.10—0.13)	0.12 (0.10—0.13)	0.11 (0.10—0.12)
	0.12 (0.05—0.18)	0.12 (0.05—0.18)	0.12 (0.05—0.18)	0.08 (0.05—0.12)	0.12 (0.05—0.18)	0.12 (0.05—0.18)	0.12 (0.05—0.18)	0.08 (0.05—0.12)	0.12 (0.05—0.20)	0.12 (0.05—0.18)	0.12 (0.05—0.18)	0.08 (0.05—0.12)
	0.12 (0.05—0.18)	0.12 (0.05—0.18)	0.12 (0.05—0.18)	0.08 (0.05—0.12)	0.12 (0.05—0.18)	0.12 (0.05—0.18)	0.12 (0.05—0.18)	0.08 (0.05—0.12)	0.12 (0.05—0.20)	0.12 (0.05—0.18)	0.12 (0.05—0.18)	0.08 (0.05—0.12)
	0.12 (0.05—0.18)	0.12 (0.05—0.18)	0.12 (0.05—0.18)	0.08 (0.05—0.12)	0.12 (0.05—0.18)	0.12 (0.05—0.18)	0.12 (0.05—0.18)	0.08 (0.05—0.12)	0.12 (0.05—0.20)	0.12 (0.05—0.18)	0.12 (0.05—0.18)	0.08 (0.05—0.12)
	0.09 (0.06—0.14)	0.07 (0.06—0.09)	—	—	0.09 (0.06—0.14)	0.07 (0.06—0.09)	—	—	0.11 (0.06—0.16)	0.09 (0.06—0.12)	—	—

ТОЧНАЯ ПЕРЕХОДНАЯ ВТУЛКА [JFS]

- Втулка спроектирована для универсальности применения сверл типа MVX и позволяет увеличивать диаметр сверления с припуском 0.1 мм.

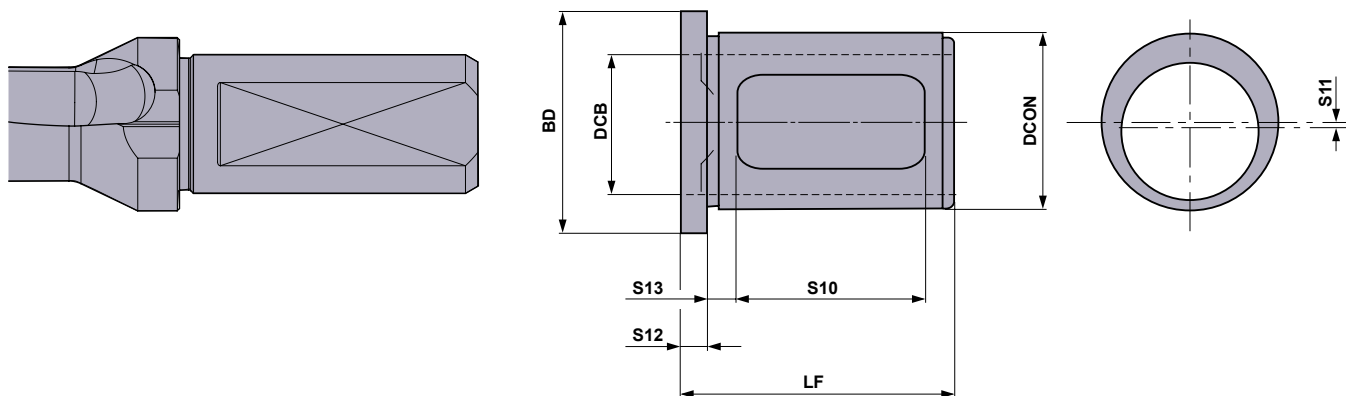

Обозначение комплекта	Обозначение втулки	Наличие	Размеры (мм)							★Увеличение (S11×2)	Подходящее сверло типа MVX
			BD	DCON	DCB	LF	S10	S12	S13		
JFS-1	JFS2520-10	●	33	25	20	43	30	5	5	0.1	MVX1700 X ØF20
	JFS2520-20	●	33	25	20	43	30	5	5	0.2	
	JFS2520-30	●	33	25	20	43	30	5	5	0.3	
	JFS2520-40	●	33	25	20	43	30	5	5	0.4	
	JFS2520-50	●	33	25	20	43	30	5	5	0.5	
JFS-2	JFS3225-10	●	40	32	25	50	34	5	5	0.1	MVX1750 X ØF25 MVX2550 X ØF25
	JFS3225-20	●	40	32	25	50	34	5	5	0.2	
	JFS3225-30	●	40	32	25	50	34	5	5	0.3	
	JFS3225-40	●	40	32	25	50	34	5	5	0.4	
	JFS3225-50	●	40	32	25	50	34	5	5	0.5	
JFS-3	JFS4032-10	●	48	40	32	55	40	5	5	0.1	MVX2600 X ØF32 MVX3000 X ØF32
	JFS4032-20	●	48	40	32	55	40	5	5	0.2	
	JFS4032-30	●	48	40	32	55	40	5	5	0.3	
	JFS4032-40	●	48	40	32	55	40	5	5	0.4	
	JFS4032-50	●	48	40	32	55	40	5	5	0.5	
JFS-4	JFS5040-10	★	68	50	40	65	50	5	5	0.1	MVX3100 X ØF40 MVX6300 X ØF40
	JFS5040-20	★	68	50	40	65	50	5	5	0.2	
	JFS5040-30	★	68	50	40	65	50	5	5	0.3	
	JFS5040-40	★	68	50	40	65	50	5	5	0.4	
	JFS5040-50	★	68	50	40	65	50	5	5	0.5	

Не подходит для сверл с диаметром хвостовика ø50 мм.

★ Увеличение: размер приращения диаметра обработки.

УКАЗАНИЯ ПО ВЫБОРУ ТОЧНОЙ ПЕРЕХОДНОЙ ВТУЛКИ

Требуемый диаметр = (φ сверла + увеличение JFS) + 0.1 мм

(Пример) Требуемый диаметр равен 20.3 мм (припуск принимается как 0.1 мм)

$$\phi 20.3 = (\text{MVX2000 X } \phi F25 + \text{JFS3225-20}) + 0.1$$

↓ сверло ø20 мм ↓ Использовано увеличение JFS равное 0.2 мм ↓ Припуск

<Выбранный инструмент>
Сверла : MVX2000 X ØF25
Точная Переходная Втулка [JFS]
: JFS3225-20

Примечание 1) Припуск может быть различным в зависимости от используемых режимов резания. Пожалуйста, используйте приведенную выше информацию как справочную.

ЗАКАЗ ТОЧНОЙ ПЕРЕХОДНОЙ ВТУЛКИ

1-й метод приобретения.

Припуск может быть различным в зависимости от используемых режимов резания. Поэтому рекомендуется заказывать комплект втулок. При размещении заказа, пожалуйста, укажите обозначение комплекта (5 втулок в комплекте).

2-й метод приобретения.

Возможен заказ одной или нескольких втулок. При размещении заказа, пожалуйста, укажите обозначение втулки.

● : Есть на складе. ★ : Со склада в Японии.

■ ПРИМЕНЕНИЕ ТОЧНОЙ ПЕРЕХОДНОЙ ВТУЛКИ

1. При установке сверла в оправку, проследите чтобы V-образная канавка на внешней боковой стороне фланца сверла совпала с круглым отверстием на внешней боковой части втулки и с винтами на боковой стороне оправки. (Если сверло не имеет V-образной канавки, выровняйте лыску на хвостовике сверла и круглые отверстия на втулке.)

2. Для крепления сверла вставьте винт А оправки для боковой фиксации непосредственно через открытую зону муфты. Затяните винт В настолько, насколько это возможно без повреждения муфты.

(Примечание)

- Хорошая настройка не может быть выполнена диаметром втулки.
- Не может использоваться со сборными зажимными оправками.

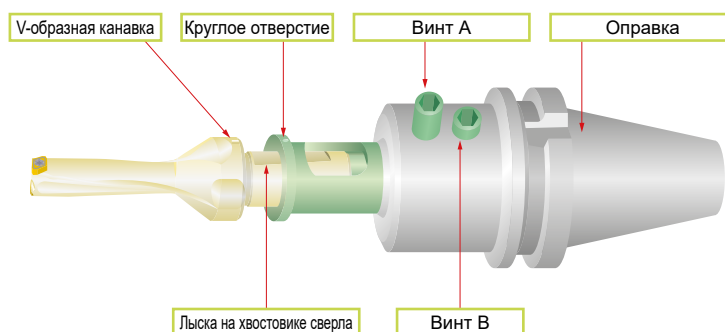

■ ПРИМЕНЕНИЕ СВЕРЛА MVX

● Использование на токарном станке

(1) Внешняя пластина и ось X станка должны располагаться параллельно. Сверло разработано таким образом, чтобы центр внутренней пластины находился на 0-0,15мм ниже при совмещении центра сверла и центра шпинделя станка.

*Может произойти поломка внутренней пластины, если высота центра внутренней пластины будет превышать высоту оси X станка.

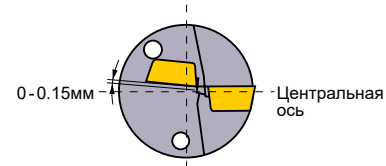

(2) Чтобы отрегулировать диаметр отверстия при помощи смещения сверла, сместите сверло в положительном направлении по оси X (увеличивая диаметр отверстия). См. список с размерами держателя для получения информации о максимальном диапазоне регулировки каждого держателя.

*Не рекомендуется выполнять регулировку в отрицательном направлении по оси X (уменьшая диаметр отверстия), т.к. это может привести к наложению отверстия и держателя.

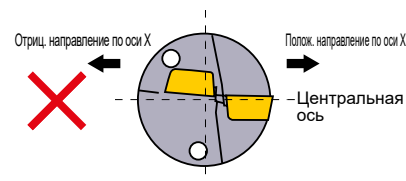

(3) При сверлении сквозных отверстий на токарном станке диск может выпасть из высверленного отверстия обрабатываемой детали с высокой скоростью. Настоятельно рекомендуется использовать защитную экипировку во избежание травм и повреждения оборудования.

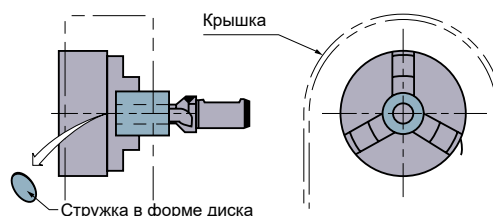

СВЕРЛА VIOLET

VAPDS

Короткая длина рабочей части, высокая точность



DC<2

DC≥2

P

M

K

N

S

H

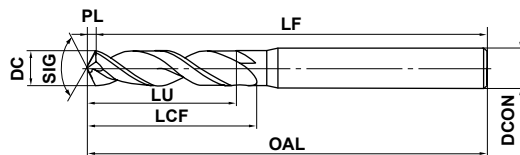

*LU = LCF-2DC (не более 3×DC)

0.5≤DC≤3	3<DC≤6	6<DC≤10	10<DC≤13
0 -0.014	0 -0.018	0 -0.022	0 -0.027



* Все сверла за исключением сверл с диаметром кратным 0.1 мм и диаметром свыше 2.0 мм имеют допуск 0—0.009 мм.

ИНСТРУМЕНТ ДЛЯ СВЕРЛЕНИЯ

M

● Благодаря новому покрытию Violet удалось повысить эффективность сверления и улучшить стойкость инструмента.

DC (мм)	Обозначение	Размеры (мм)					Наличие
		LCF	OAL	LF	PL	DCON	
0.50	VAPDSD0050	3.2	50.2	50	0.15	3	●
0.51	VAPDSD0051	3.2	50.2	50	0.15	3	★
0.52	VAPDSD0052	3.2	50.2	50	0.16	3	★
0.53	VAPDSD0053	3.2	50.2	50	0.16	3	★
0.54	VAPDSD0054	3.2	50.2	50	0.16	3	★
0.55	VAPDSD0055	3.2	50.2	50	0.17	3	★
0.56	VAPDSD0056	4.2	50.2	50	0.17	3	★
0.57	VAPDSD0057	4.2	50.2	50	0.17	3	★
0.58	VAPDSD0058	4.2	50.2	50	0.17	3	★
0.59	VAPDSD0059	4.2	50.2	50	0.18	3	★
0.60	VAPDSD0060	5.2	50.2	50	0.18	3	★
0.61	VAPDSD0061	5.2	50.2	50	0.18	3	★
0.62	VAPDSD0062	5.2	50.2	50	0.19	3	★
0.63	VAPDSD0063	5.2	50.2	50	0.19	3	★
0.64	VAPDSD0064	5.2	50.2	50	0.19	3	★
0.65	VAPDSD0065	5.2	50.2	50	0.20	3	★
0.66	VAPDSD0066	5.2	50.2	50	0.20	3	★
0.67	VAPDSD0067	5.2	50.2	50	0.20	3	★
0.68	VAPDSD0068	5.2	50.2	50	0.20	3	★
0.69	VAPDSD0069	5.2	50.2	50	0.21	3	★
0.70	VAPDSD0070	5.2	50.2	50	0.21	3	★
0.71	VAPDSD0071	5.2	50.2	50	0.21	3	★
0.72	VAPDSD0072	5.2	50.2	50	0.22	3	★
0.73	VAPDSD0073	5.2	50.2	50	0.22	3	★
0.74	VAPDSD0074	5.2	50.2	50	0.22	3	★
0.75	VAPDSD0075	5.2	50.2	50	0.23	3	★
0.76	VAPDSD0076	5.2	50.2	50	0.23	3	★
0.77	VAPDSD0077	5.2	50.2	50	0.23	3	★
0.78	VAPDSD0078	5.2	50.2	50	0.23	3	★
0.79	VAPDSD0079	5.2	50.2	50	0.24	3	★
0.80	VAPDSD0080	5.2	50.2	50	0.24	3	★
0.81	VAPDSD0081	5.2	50.2	50	0.24	3	★
0.82	VAPDSD0082	5.3	50.3	50	0.25	3	★

DC (мм)	Обозначение	Размеры (мм)					Наличие
		LCF	OAL	LF	PL	DCON	
0.83	VAPDSD0083	5.3	50.3	50	0.25	3	★
0.84	VAPDSD0084	5.3	50.3	50	0.25	3	★
0.85	VAPDSD0085	5.3	50.3	50	0.26	3	★
0.86	VAPDSD0086	6.3	50.3	50	0.26	3	★
0.87	VAPDSD0087	6.3	50.3	50	0.26	3	★
0.88	VAPDSD0088	6.3	50.3	50	0.26	3	★
0.89	VAPDSD0089	6.3	50.3	50	0.27	3	★
0.90	VAPDSD0090	6.3	50.3	50	0.27	3	★
0.91	VAPDSD0091	6.3	50.3	50	0.27	3	★
0.92	VAPDSD0092	6.3	50.3	50	0.28	3	★
0.93	VAPDSD0093	6.3	50.3	50	0.28	3	★
0.94	VAPDSD0094	6.3	50.3	50	0.28	3	★
0.95	VAPDSD0095	6.3	50.3	50	0.29	3	★
0.96	VAPDSD0096	6.3	50.3	50	0.29	3	★
0.97	VAPDSD0097	6.3	50.3	50	0.29	3	★
0.98	VAPDSD0098	6.3	50.3	50	0.29	3	★
0.99	VAPDSD0099	6.3	50.3	50	0.30	3	★
1.00	VAPDSD0100	6.3	50.3	50	0.3	3	●
1.01	VAPDSD0101	6.3	50.3	50	0.3	3	★
1.02	VAPDSD0102	6.3	50.3	50	0.3	3	★
1.03	VAPDSD0103	6.3	50.3	50	0.3	3	★
1.04	VAPDSD0104	6.3	50.3	50	0.3	3	★
1.05	VAPDSD0105	6.3	50.3	50	0.3	3	★
1.06	VAPDSD0106	6.3	50.3	50	0.3	3	★
1.07	VAPDSD0107	8.3	55.3	55	0.3	3	★
1.08	VAPDSD0108	8.3	55.3	55	0.3	3	★
1.09	VAPDSD0109	8.3	55.3	55	0.3	3	★
1.10	VAPDSD0110	8.3	55.3	55	0.3	3	★
1.11	VAPDSD0111	8.3	55.3	55	0.3	3	★
1.12	VAPDSD0112	8.3	55.3	55	0.3	3	★
1.13	VAPDSD0113	8.3	55.3	55	0.3	3	★
1.14	VAPDSD0114	8.3	55.3	55	0.3	3	★
1.15	VAPDSD0115	8.4	55.4	55	0.4	3	★

● : Есть на складе. ★ : Со склада в Японии.

DC (мм)	Обозначение	Размеры (мм)					Наличие
		LCF	OAL	LF	PL	DCON	
1.16	VAPDSD0116	8.4	55.4	55	0.4	3	★
1.17	VAPDSD0117	8.4	55.4	55	0.4	3	★
1.18	VAPDSD0118	8.4	55.4	55	0.4	3	★
1.19	VAPDSD0119	8.4	55.4	55	0.4	3	★
1.20	VAPDSD0120	8.4	55.4	55	0.4	3	★
1.21	VAPDSD0121	8.4	55.4	55	0.4	3	★
1.22	VAPDSD0122	8.4	55.4	55	0.4	3	★
1.23	VAPDSD0123	8.4	55.4	55	0.4	3	★
1.24	VAPDSD0124	8.4	55.4	55	0.4	3	★
1.25	VAPDSD0125	8.4	55.4	55	0.4	3	★
1.26	VAPDSD0126	8.4	55.4	55	0.4	3	★
1.27	VAPDSD0127	8.4	55.4	55	0.4	3	★
1.28	VAPDSD0128	8.4	55.4	55	0.4	3	★
1.29	VAPDSD0129	8.4	55.4	55	0.4	3	★
1.30	VAPDSD0130	9.4	55.4	55	0.4	3	★
1.31	VAPDSD0131	9.4	55.4	55	0.4	3	★
1.32	VAPDSD0132	9.4	55.4	55	0.4	3	★
1.33	VAPDSD0133	9.4	55.4	55	0.4	3	★
1.34	VAPDSD0134	9.4	55.4	55	0.4	3	★
1.35	VAPDSD0135	9.4	55.4	55	0.4	3	★
1.36	VAPDSD0136	9.4	55.4	55	0.4	3	★
1.37	VAPDSD0137	9.4	55.4	55	0.4	3	★
1.38	VAPDSD0138	9.4	55.4	55	0.4	3	★
1.39	VAPDSD0139	9.4	55.4	55	0.4	3	★
1.40	VAPDSD0140	9.4	55.4	55	0.4	3	★
1.41	VAPDSD0141	9.4	55.4	55	0.4	3	★
1.42	VAPDSD0142	9.4	55.4	55	0.4	3	★
1.43	VAPDSD0143	9.4	55.4	55	0.4	3	★
1.44	VAPDSD0144	9.4	55.4	55	0.4	3	★
1.45	VAPDSD0145	9.4	55.4	55	0.4	3	★
1.46	VAPDSD0146	9.4	55.4	55	0.4	3	★
1.47	VAPDSD0147	9.4	55.4	55	0.4	3	★
1.48	VAPDSD0148	9.4	55.4	55	0.4	3	★
1.49	VAPDSD0149	9.5	55.5	55	0.5	3	★
1.50	VAPDSD0150	9.5	55.5	55	0.5	3	●
1.51	VAPDSD0151	11.5	55.5	55	0.5	3	★
1.52	VAPDSD0152	11.5	55.5	55	0.5	3	★
1.53	VAPDSD0153	11.5	55.5	55	0.5	3	★
1.54	VAPDSD0154	11.5	55.5	55	0.5	3	★
1.55	VAPDSD0155	11.5	55.5	55	0.5	3	★
1.56	VAPDSD0156	11.5	55.5	55	0.5	3	★
1.57	VAPDSD0157	11.5	55.5	55	0.5	3	★
1.58	VAPDSD0158	11.5	55.5	55	0.5	3	★
1.59	VAPDSD0159	11.5	55.5	55	0.5	3	★
1.60	VAPDSD0160	11.5	55.5	55	0.5	3	★
1.61	VAPDSD0161	11.5	55.5	55	0.5	3	★
1.62	VAPDSD0162	11.5	55.5	55	0.5	3	★
1.63	VAPDSD0163	11.5	55.5	55	0.5	3	★
1.64	VAPDSD0164	11.5	55.5	55	0.5	3	★
1.65	VAPDSD0165	11.5	55.5	55	0.5	3	★

DC (мм)	Обозначение	Размеры (мм)					Наличие
		LCF	OAL	LF	PL	DCON	
1.66	VAPDSD0166	11.5	55.5	55	0.5	3	★
1.67	VAPDSD0167	11.5	55.5	55	0.5	3	★
1.68	VAPDSD0168	11.5	55.5	55	0.5	3	★
1.69	VAPDSD0169	11.5	55.5	55	0.5	3	★
1.70	VAPDSD0170	11.5	55.5	55	0.5	3	★
1.71	VAPDSD0171	11.5	55.5	55	0.5	3	★
1.72	VAPDSD0172	11.5	55.5	55	0.5	3	★
1.73	VAPDSD0173	11.5	55.5	55	0.5	3	★
1.74	VAPDSD0174	11.5	55.5	55	0.5	3	★
1.75	VAPDSD0175	11.5	55.5	55	0.5	3	★
1.76	VAPDSD0176	11.5	55.5	55	0.5	3	★
1.77	VAPDSD0177	11.5	55.5	55	0.5	3	★
1.78	VAPDSD0178	11.5	55.5	55	0.5	3	★
1.79	VAPDSD0179	11.5	55.5	55	0.5	3	★
1.80	VAPDSD0180	11.5	55.5	55	0.5	3	★
1.81	VAPDSD0181	11.5	55.5	55	0.5	3	★
1.82	VAPDSD0182	11.6	55.6	55	0.6	3	★
1.83	VAPDSD0183	11.6	55.6	55	0.6	3	★
1.84	VAPDSD0184	11.6	55.6	55	0.6	3	★
1.85	VAPDSD0185	11.6	55.6	55	0.6	3	★
1.86	VAPDSD0186	11.6	55.6	55	0.6	3	★
1.87	VAPDSD0187	11.6	55.6	55	0.6	3	★
1.88	VAPDSD0188	11.6	55.6	55	0.6	3	★
1.89	VAPDSD0189	11.6	55.6	55	0.6	3	★
1.90	VAPDSD0190	12.6	55.6	55	0.6	3	★
1.91	VAPDSD0191	12.6	60.6	60	0.6	3	★
1.92	VAPDSD0192	12.6	60.6	60	0.6	3	★
1.93	VAPDSD0193	12.6	60.6	60	0.6	3	★
1.94	VAPDSD0194	12.6	60.6	60	0.6	3	★
1.95	VAPDSD0195	12.6	60.6	60	0.6	3	★
1.96	VAPDSD0196	12.6	60.6	60	0.6	3	★
1.97	VAPDSD0197	12.6	60.6	60	0.6	3	★
1.98	VAPDSD0198	12.6	60.6	60	0.6	3	★
1.99	VAPDSD0199	12.6	60.6	60	0.6	3	★
2.00	VAPDSD0200	12.4	60.4	60	0.4	3	●
2.05	VAPDSD0205	12.4	60.4	60	0.4	3	★
2.10	VAPDSD0210	12.4	60.4	60	0.4	3	★
2.15	VAPDSD0215	12.5	60.5	60	0.5	3	★
2.20	VAPDSD0220	12.5	60.5	60	0.5	3	★
2.25	VAPDSD0225	12.5	60.5	60	0.5	3	★
2.30	VAPDSD0230	13.5	60.5	60	0.5	3	★
2.35	VAPDSD0235	13.5	60.5	60	0.5	3	★
2.40	VAPDSD0240	13.5	60.5	60	0.5	3	★
2.45	VAPDSD0245	13.5	60.5	60	0.5	3	★
2.50	VAPDSD0250	13.5	60.5	60	0.5	3	●
2.55	VAPDSD0255	13.5	60.5	60	0.5	3	★
2.60	VAPDSD0260	15.5	60.5	60	0.5	3	★
2.65	VAPDSD0265	15.6	60.6	60	0.6	3	★
2.70	VAPDSD0270	15.6	60.6	60	0.6	3	★
2.75	VAPDSD0275	15.6	60.6	60	0.6	3	★

М
ИНСТРУМЕНТ ДЛЯ
СВЕРЛЕНИЯ

VAPDS

Короткая длина рабочей части, высокая точность

Быстрорежущая
сталь

ИНСТРУМЕНТ ДЛЯ
СВЕРЛЕНИЯ

M

DC (мм)	Обозначение	Размеры (мм)					Наличие
		LCF	OAL	LF	PL	DCON	
2.80	VAPDSD0280	15.6	60.6	60	0.6	3	★
2.85	VAPDSD0285	15.6	60.6	60	0.6	3	★
2.90	VAPDSD0290	15.6	60.6	60	0.6	3	★
2.95	VAPDSD0295	15.6	60.6	60	0.6	3	★
3.00	VAPDSD0300	15.6	60.6	60	0.6	3	●
3.05	VAPDSD0305	17.6	70.6	70	0.6	4	★
3.10	VAPDSD0310	17.6	70.6	70	0.6	4	★
3.15	VAPDSD0315	17.7	70.7	70	0.7	4	★
3.20	VAPDSD0320	17.7	70.7	70	0.7	4	★
3.25	VAPDSD0325	17.7	70.7	70	0.7	4	★
3.30	VAPDSD0330	19.7	70.7	70	0.7	4	★
3.35	VAPDSD0335	19.7	70.7	70	0.7	4	★
3.40	VAPDSD0340	19.7	70.7	70	0.7	4	★
3.45	VAPDSD0345	19.7	70.7	70	0.7	4	★
3.50	VAPDSD0350	19.7	70.7	70	0.7	4	●
3.55	VAPDSD0355	19.7	70.7	70	0.7	4	★
3.60	VAPDSD0360	21.8	70.8	70	0.8	4	★
3.65	VAPDSD0365	21.8	70.8	70	0.8	4	★
3.70	VAPDSD0370	21.8	70.8	70	0.8	4	★
3.75	VAPDSD0375	21.8	70.8	70	0.8	4	★
3.80	VAPDSD0380	21.8	70.8	70	0.8	4	★
3.85	VAPDSD0385	21.8	70.8	70	0.8	4	★
3.90	VAPDSD0390	21.8	70.8	70	0.8	4	★
3.95	VAPDSD0395	21.8	70.8	70	0.8	4	★
4.00	VAPDSD0400	21.8	70.8	70	0.8	4	●
4.05	VAPDSD0405	21.8	80.8	80	0.8	6	★
4.10	VAPDSD0410	21.9	80.9	80	0.9	6	★
4.15	VAPDSD0415	21.9	80.9	80	0.9	6	★
4.20	VAPDSD0420	21.9	80.9	80	0.9	6	★
4.25	VAPDSD0425	21.9	80.9	80	0.9	6	★
4.30	VAPDSD0430	23.9	80.9	80	0.9	6	★
4.35	VAPDSD0435	23.9	80.9	80	0.9	6	★
4.40	VAPDSD0440	23.9	80.9	80	0.9	6	★
4.45	VAPDSD0445	23.9	80.9	80	0.9	6	★
4.50	VAPDSD0450	23.9	80.9	80	0.9	6	●
4.55	VAPDSD0455	23.9	80.9	80	0.9	6	★
4.60	VAPDSD0460	26.0	81.0	80	1.0	6	★
4.65	VAPDSD0465	26.0	81.0	80	1.0	6	★
4.70	VAPDSD0470	26.0	81.0	80	1.0	6	★
4.75	VAPDSD0475	26.0	81.0	80	1.0	6	★
4.80	VAPDSD0480	26.0	81.0	80	1.0	6	★
4.85	VAPDSD0485	26.0	81.0	80	1.0	6	★
4.90	VAPDSD0490	26.0	81.0	80	1.0	6	★
4.95	VAPDSD0495	26.0	81.0	80	1.0	6	★
5.00	VAPDSD0500	26.0	81.0	80	1.0	6	●
5.05	VAPDSD0505	26.1	81.1	80	1.1	6	★
5.10	VAPDSD0510	26.1	81.1	80	1.1	6	★
5.15	VAPDSD0515	26.1	81.1	80	1.1	6	★
5.20	VAPDSD0520	26.1	81.1	80	1.1	6	★
5.25	VAPDSD0525	26.1	81.1	80	1.1	6	★

DC (мм)	Обозначение	Размеры (мм)					Наличие
		LCF	OAL	LF	PL	DCON	
5.30	VAPDSD0530	26.1	81.1	80	1.1	6	★
5.35	VAPDSD0535	28.1	81.1	80	1.1	6	★
5.40	VAPDSD0540	28.1	81.1	80	1.1	6	★
5.45	VAPDSD0545	28.1	81.1	80	1.1	6	★
5.50	VAPDSD0550	28.1	81.1	80	1.1	6	●
5.55	VAPDSD0555	28.2	81.2	80	1.2	6	★
5.60	VAPDSD0560	28.2	81.2	80	1.2	6	★
5.65	VAPDSD0565	28.2	81.2	80	1.2	6	★
5.70	VAPDSD0570	28.2	81.2	80	1.2	6	★
5.75	VAPDSD0575	28.2	81.2	80	1.2	6	★
5.80	VAPDSD0580	28.2	81.2	80	1.2	6	★
5.85	VAPDSD0585	28.2	81.2	80	1.2	6	★
5.90	VAPDSD0590	28.2	81.2	80	1.2	6	★
5.95	VAPDSD0595	28.2	81.2	80	1.2	6	★
6.00	VAPDSD0600	28.2	81.2	80	1.2	6	●
6.05	VAPDSD0605	31.3	81.3	80	1.3	8	★
6.10	VAPDSD0610	31.3	81.3	80	1.3	8	★
6.15	VAPDSD0615	31.3	81.3	80	1.3	8	★
6.20	VAPDSD0620	31.3	81.3	80	1.3	8	★
6.25	VAPDSD0625	31.3	81.3	80	1.3	8	★
6.30	VAPDSD0630	31.3	81.3	80	1.3	8	★
6.35	VAPDSD0635	31.3	81.3	80	1.3	8	★
6.40	VAPDSD0640	31.3	81.3	80	1.3	8	★
6.45	VAPDSD0645	31.3	81.3	80	1.3	8	★
6.50	VAPDSD0650	31.4	81.4	80	1.4	8	●
6.55	VAPDSD0655	31.4	81.4	80	1.4	8	★
6.60	VAPDSD0660	31.4	81.4	80	1.4	8	★
6.65	VAPDSD0665	31.4	81.4	80	1.4	8	★
6.70	VAPDSD0670	31.4	81.4	80	1.4	8	★
6.75	VAPDSD0675	33.4	81.4	80	1.4	8	★
6.80	VAPDSD0680	33.4	81.4	80	1.4	8	★
6.85	VAPDSD0685	33.4	81.4	80	1.4	8	★
6.90	VAPDSD0690	33.4	81.4	80	1.4	8	★
6.95	VAPDSD0695	33.4	81.4	80	1.4	8	★
7.00	VAPDSD0700	33.5	81.5	80	1.5	8	●
7.05	VAPDSD0705	33.5	81.5	80	1.5	8	★
7.10	VAPDSD0710	33.5	81.5	80	1.5	8	★
7.15	VAPDSD0715	33.5	81.5	80	1.5	8	★
7.20	VAPDSD0720	33.5	81.5	80	1.5	8	★
7.25	VAPDSD0725	33.5	81.5	80	1.5	8	★
7.30	VAPDSD0730	33.5	81.5	80	1.5	8	★
7.35	VAPDSD0735	33.5	81.5	80	1.5	8	★
7.40	VAPDSD0740	33.5	81.5	80	1.5	8	★
7.45	VAPDSD0745	33.5	81.5	80	1.5	8	★
7.50	VAPDSD0750	33.6	81.6	80	1.6	8	●
7.55	VAPDSD0755	36.6	86.6	85	1.6	8	★
7.60	VAPDSD0760	36.6	86.6	85	1.6	8	★
7.65	VAPDSD0765	36.6	86.6	85	1.6	8	★
7.70	VAPDSD0770	36.6	86.6	85	1.6	8	★
7.75	VAPDSD0775	36.6	86.6	85	1.6	8	★

● : Есть на складе. ★ : Со склада в Японии.

DC (мм)	Обозначение	Размеры (мм)					Наличие
		LCF	OAL	LF	PL	DCON	
7.80	VAPDSD0780	36.6	86.6	85	1.6	8	★
7.85	VAPDSD0785	36.6	86.6	85	1.6	8	★
7.90	VAPDSD0790	36.6	86.6	85	1.6	8	★
7.95	VAPDSD0795	36.7	86.7	85	1.7	8	★
8.00	VAPDSD0800	36.7	86.7	85	1.7	8	●
8.05	VAPDSD0805	36.7	91.7	90	1.7	10	★
8.10	VAPDSD0810	36.7	91.7	90	1.7	10	★
8.15	VAPDSD0815	36.7	91.7	90	1.7	10	★
8.20	VAPDSD0820	36.7	91.7	90	1.7	10	★
8.25	VAPDSD0825	36.7	91.7	90	1.7	10	★
8.30	VAPDSD0830	36.7	91.7	90	1.7	10	★
8.35	VAPDSD0835	36.7	91.7	90	1.7	10	★
8.40	VAPDSD0840	36.7	91.7	90	1.7	10	★
8.45	VAPDSD0845	36.8	91.8	90	1.8	10	★
8.50	VAPDSD0850	36.8	91.8	90	1.8	10	●
8.55	VAPDSD0855	39.8	94.8	93	1.8	10	★
8.60	VAPDSD0860	39.8	94.8	93	1.8	10	★
8.65	VAPDSD0865	39.8	94.8	93	1.8	10	★
8.70	VAPDSD0870	39.8	94.8	93	1.8	10	★
8.75	VAPDSD0875	39.8	94.8	93	1.8	10	★
8.80	VAPDSD0880	39.8	94.8	93	1.8	10	★
8.85	VAPDSD0885	39.8	94.8	93	1.8	10	★
8.90	VAPDSD0890	39.8	94.8	93	1.8	10	★
8.95	VAPDSD0895	39.9	94.9	93	1.9	10	★
9.00	VAPDSD0900	39.9	94.9	93	1.9	10	●
9.10	VAPDSD0910	39.9	94.9	93	1.9	10	★
9.20	VAPDSD0920	39.9	94.9	93	1.9	10	★
9.30	VAPDSD0930	39.9	94.9	93	1.9	10	★
9.40	VAPDSD0940	40.0	95.0	93	2.0	10	★
9.50	VAPDSD0950	40.0	95.0	93	2.0	10	●
9.60	VAPDSD0960	43.0	98.0	96	2.0	10	★
9.70	VAPDSD0970	43.0	98.0	96	2.0	10	★
9.80	VAPDSD0980	43.0	98.0	96	2.0	10	★
9.90	VAPDSD0990	43.1	98.1	96	2.1	10	★
10.00	VAPDSD1000	43.1	98.1	96	2.1	10	●
10.10	VAPDSD1010	43.1	103.1	101	2.1	12	★
10.20	VAPDSD1020	43.1	103.1	101	2.1	12	★
10.30	VAPDSD1030	43.1	103.1	101	2.1	12	★
10.40	VAPDSD1040	43.2	103.2	101	2.2	12	★
10.50	VAPDSD1050	43.2	103.2	101	2.2	12	●
10.60	VAPDSD1060	43.2	103.2	101	2.2	12	★
10.70	VAPDSD1070	47.2	107.2	105	2.2	12	★
10.80	VAPDSD1080	47.2	107.2	105	2.2	12	★
10.90	VAPDSD1090	47.3	107.3	105	2.3	12	★
11.00	VAPDSD1100	47.3	107.3	105	2.3	12	●
11.10	VAPDSD1110	47.3	107.3	105	2.3	12	★
11.20	VAPDSD1120	47.3	107.3	105	2.3	12	★
11.30	VAPDSD1130	47.3	107.3	105	2.3	12	★
11.40	VAPDSD1140	47.4	107.4	105	2.4	12	★
11.50	VAPDSD1150	47.4	107.4	105	2.4	12	★

DC (мм)	Обозначение	Размеры (мм)					Наличие
		LCF	OAL	LF	PL	DCON	
11.60	VAPDSD1160	47.4	107.4	105	2.4	12	★
11.70	VAPDSD1170	47.4	107.4	105	2.4	12	★
11.80	VAPDSD1180	47.4	107.4	105	2.4	12	★
11.90	VAPDSD1190	51.5	111.5	109	2.5	12	★
12.00	VAPDSD1200	51.5	111.5	109	2.5	12	●
12.10	VAPDSD1210	51.5	111.5	109	2.5	12	★
12.20	VAPDSD1220	51.5	111.5	109	2.5	12	★
12.30	VAPDSD1230	51.6	111.6	109	2.6	12	★
12.40	VAPDSD1240	51.6	111.6	109	2.6	12	★
12.50	VAPDSD1250	51.6	111.6	109	2.6	12	●
12.60	VAPDSD1260	51.6	111.6	109	2.6	12	★
12.70	VAPDSD1270	51.6	111.6	109	2.6	12	★
12.80	VAPDSD1280	51.7	111.7	109	2.7	12	★
12.90	VAPDSD1290	51.7	111.7	109	2.7	12	★
13.00	VAPDSD1300	51.7	111.7	109	2.7	12	★

M

ИНСТРУМЕНТ ДЛЯ
СВЕРЛЕНИЯ

РЕКОМЕНДУЕМЫЕ РЕЖИМЫ РЕЗАНИЯ

Обработываемый материал	P		P	K	P	M	P	M
	Конструкционная сталь	Углеродистая сталь S _k 55 Легированная сталь 070M55 Чугун	Легированная инструментальная сталь X210Cr12 (Материалы низкой твердости) Ферритная нержавеющая сталь X10CrAl18, X10CrAl13 Мартенситная нержавеющая сталь X20Cr13, X10CrAl13	Легированная инструментальная сталь X40CrMoV51 (-40HRC) Нержавеющая сталь с дисперсионным упрочнением X7CrNiAl177				
Диам. сверла DC (мм)	Частота вращения (мин ⁻¹)	Подача (мм/об)	Частота вращения (мин ⁻¹)	Подача (мм/об)	Частота вращения (мин ⁻¹)	Подача (мм/об)	Частота вращения (мин ⁻¹)	Подача (мм/об)
0.5	18000	0.02	16000	0.02	9000	0.02	8200	0.02
1.0	12000	0.05	10000	0.05	6300	0.05	5500	0.04
2.0	6400	0.09	5500	0.09	3200	0.09	2900	0.05
3.0	4300	0.13	3700	0.13	2100	0.13	1900	0.06
4.0	3200	0.15	2800	0.15	1600	0.15	1400	0.08
5.0	2600	0.18	2200	0.18	1300	0.18	1100	0.10
6.0	2100	0.19	1800	0.19	1100	0.20	950	0.11
8.0	1600	0.24	1400	0.24	800	0.22	720	0.13
10.0	1300	0.28	1100	0.28	640	0.25	570	0.15
12.0	1100	0.34	930	0.34	530	0.30	480	0.17
13.0	980	0.36	860	0.36	490	0.32	440	0.19

Примечание 1) Пожалуйста, снизьте обороты и подачу при недостаточной жесткости закрепленной детали или ограничениях станка.

Примечание 2) Пожалуйста, используйте сверлильную или фрезерную оправку цангового типа.

Примечание 3) Используйте достаточное количество СОЖ.

Примечание 4) При сверлении отверстий глубиной более 4 x DC сверла, используйте подачу с периодическим выводом сверла из отверстия.

Примечание 5) Вышеупомянутые режимы резания указаны для обработки с СОЖ.

Пожалуйста, снизьте обороты при обработке без СОЖ.

M

**ИНСТРУМЕНТ ДЛЯ
СВЕРЛЕНИЯ**

VAPDM

Средняя длина рабочей части, высокая точность



Быстрорежущая
сталь

DC<2

DC≥2

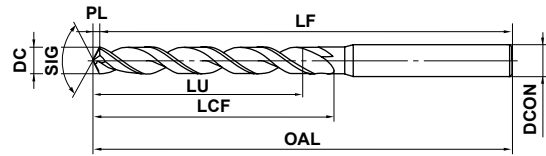

*LU = LCF-2DC (не более 5×DC)



0.5≤DC≤3	3<DC≤6	6<DC≤10	10<DC≤18	18<DC≤30	30<DC≤32
0 -0.014	0 -0.018	0 -0.022	0 -0.027	0 -0.033	0 -0.039

- Благодаря новому покрытию Violet удалось повысить эффективность сверления и улучшить стойкость инструмента.

DC (мм)	Обозначение	Размеры (мм)					Наличие
		LCF	OAL	LF	PL	DCON	
0.50	VAPDMD0050	6.2	50.2	50	0.15	3	●
0.55	VAPDMD0055	6.2	50.2	50	0.17	3	★
0.60	VAPDMD0060	8.2	50.2	50	0.18	3	★
0.65	VAPDMD0065	8.2	50.2	50	0.20	3	★
0.70	VAPDMD0070	10.2	50.2	50	0.21	3	★
0.75	VAPDMD0075	10.2	50.2	50	0.23	3	★
0.80	VAPDMD0080	10.2	50.2	50	0.24	3	★
0.85	VAPDMD0085	10.3	50.3	50	0.26	3	★
0.90	VAPDMD0090	12.3	50.3	50	0.27	3	★
0.95	VAPDMD0095	12.3	50.3	50	0.29	3	★
1.00	VAPDMD0100	12.3	60.3	60	0.3	3	●
1.05	VAPDMD0105	12.3	60.3	60	0.3	3	★
1.10	VAPDMD0110	16.3	60.3	60	0.3	3	★
1.15	VAPDMD0115	16.4	60.4	60	0.4	3	★
1.20	VAPDMD0120	16.4	60.4	60	0.4	3	★
1.25	VAPDMD0125	16.4	60.4	60	0.4	3	★
1.30	VAPDMD0130	16.4	60.4	60	0.4	3	★
1.35	VAPDMD0135	18.4	60.4	60	0.4	3	★
1.40	VAPDMD0140	18.4	60.4	60	0.4	3	★
1.45	VAPDMD0145	18.4	60.4	60	0.4	3	★
1.50	VAPDMD0150	18.5	60.5	60	0.5	3	●
1.55	VAPDMD0155	20.5	60.5	60	0.5	3	★
1.60	VAPDMD0160	20.5	60.5	60	0.5	3	★
1.65	VAPDMD0165	20.5	60.5	60	0.5	3	★
1.70	VAPDMD0170	20.5	60.5	60	0.5	3	★
1.75	VAPDMD0175	20.5	60.5	60	0.5	3	★
1.80	VAPDMD0180	22.5	60.5	60	0.5	3	★
1.85	VAPDMD0185	22.6	60.6	60	0.6	3	★
1.90	VAPDMD0190	22.6	60.6	60	0.6	3	★
1.95	VAPDMD0195	23.6	60.6	60	0.6	3	★
2.00	VAPDMD0200	23.4	70.4	70	0.4	3	●
2.05	VAPDMD0205	23.4	70.4	70	0.4	3	★
2.10	VAPDMD0210	23.4	70.4	70	0.4	3	★

DC (мм)	Обозначение	Размеры (мм)					Наличие
		LCF	OAL	LF	PL	DCON	
2.15	VAPDMD0215	23.5	70.5	70	0.5	3	★
2.20	VAPDMD0220	26.5	70.5	70	0.5	3	★
2.25	VAPDMD0225	26.5	70.5	70	0.5	3	★
2.30	VAPDMD0230	26.5	70.5	70	0.5	3	★
2.35	VAPDMD0235	26.5	70.5	70	0.5	3	★
2.40	VAPDMD0240	29.5	70.5	70	0.5	3	★
2.45	VAPDMD0245	29.5	70.5	70	0.5	3	★
2.50	VAPDMD0250	29.5	70.5	70	0.5	3	●
2.55	VAPDMD0255	29.5	70.5	70	0.5	3	★
2.60	VAPDMD0260	29.5	70.5	70	0.5	3	★
2.65	VAPDMD0265	29.6	70.6	70	0.6	3	★
2.70	VAPDMD0270	32.6	70.6	70	0.6	3	★
2.75	VAPDMD0275	32.6	70.6	70	0.6	3	★
2.80	VAPDMD0280	32.6	70.6	70	0.6	3	★
2.85	VAPDMD0285	32.6	70.6	70	0.6	3	★
2.90	VAPDMD0290	32.6	70.6	70	0.6	3	★
2.95	VAPDMD0295	32.6	70.6	70	0.6	3	★
3.00	VAPDMD0300	32.6	70.6	70	0.6	3	●
3.05	VAPDMD0305	35.6	85.6	85	0.6	4	★
3.10	VAPDMD0310	35.6	85.6	85	0.6	4	★
3.15	VAPDMD0315	35.7	85.7	85	0.7	4	★
3.20	VAPDMD0320	35.7	85.7	85	0.7	4	★
3.25	VAPDMD0325	35.7	85.7	85	0.7	4	★
3.30	VAPDMD0330	35.7	85.7	85	0.7	4	★
3.35	VAPDMD0335	35.7	85.7	85	0.7	4	★
3.40	VAPDMD0340	38.7	85.7	85	0.7	4	★
3.45	VAPDMD0345	38.7	85.7	85	0.7	4	★
3.50	VAPDMD0350	38.7	85.7	85	0.7	4	●
3.55	VAPDMD0355	38.7	85.7	85	0.7	4	★
3.60	VAPDMD0360	38.8	85.8	85	0.8	4	★
3.65	VAPDMD0365	38.8	85.8	85	0.8	4	★
3.70	VAPDMD0370	38.8	85.8	85	0.8	4	★
3.75	VAPDMD0375	42.8	85.8	85	0.8	4	★

М
ИНСТРУМЕНТ ДЛЯ
СВЕРЛЕНИЯ

● : Есть на складе. ★ : Со склада в Японии.

РЕЖИМЫ РЕЗАНИЯ > M182
ТЕХНИЧЕСКИЕ ДАННЫЕ > P001

M179

VAPDM

Средняя длина рабочей части, высокая точность

Быстрорежущая
сталь

M

ИНСТРУМЕНТ ДЛЯ
СВЕРЛЕНИЯ

DC (мм)	Обозначение	Размеры (мм)					Наличие
		LCF	OAL	LF	PL	DCON	
3.80	VAPDMD0380	42.8	85.8	85	0.8	4	★
3.85	VAPDMD0385	42.8	85.8	85	0.8	4	★
3.90	VAPDMD0390	42.8	85.8	85	0.8	4	★
3.95	VAPDMD0395	42.8	85.8	85	0.8	4	★
4.00	VAPDMD0400	42.8	85.8	85	0.8	4	●
4.05	VAPDMD0405	42.8	100.8	100	0.8	6	★
4.10	VAPDMD0410	42.9	100.9	100	0.9	6	★
4.15	VAPDMD0415	42.9	100.9	100	0.9	6	★
4.20	VAPDMD0420	42.9	100.9	100	0.9	6	★
4.25	VAPDMD0425	46.9	100.9	100	0.9	6	★
4.30	VAPDMD0430	46.9	100.9	100	0.9	6	★
4.35	VAPDMD0435	46.9	100.9	100	0.9	6	★
4.40	VAPDMD0440	46.9	100.9	100	0.9	6	★
4.45	VAPDMD0445	46.9	100.9	100	0.9	6	★
4.50	VAPDMD0450	46.9	100.9	100	0.9	6	●
4.55	VAPDMD0455	46.9	100.9	100	0.9	6	★
4.60	VAPDMD0460	47.0	101.0	100	1.0	6	★
4.65	VAPDMD0465	47.0	101.0	100	1.0	6	★
4.70	VAPDMD0470	47.0	101.0	100	1.0	6	★
4.75	VAPDMD0475	47.0	101.0	100	1.0	6	★
4.80	VAPDMD0480	52.0	101.0	100	1.0	6	★
4.85	VAPDMD0485	52.0	101.0	100	1.0	6	★
4.90	VAPDMD0490	52.0	101.0	100	1.0	6	★
4.95	VAPDMD0495	52.0	101.0	100	1.0	6	★
5.00	VAPDMD0500	52.0	101.0	100	1.0	6	●
5.05	VAPDMD0505	52.1	101.1	100	1.1	6	★
5.10	VAPDMD0510	52.1	101.1	100	1.1	6	★
5.15	VAPDMD0515	52.1	101.1	100	1.1	6	★
5.20	VAPDMD0520	52.1	101.1	100	1.1	6	★
5.25	VAPDMD0525	52.1	101.1	100	1.1	6	★
5.30	VAPDMD0530	52.1	101.1	100	1.1	6	★
5.35	VAPDMD0535	57.1	107.1	106	1.1	6	★
5.40	VAPDMD0540	57.1	107.1	106	1.1	6	★
5.45	VAPDMD0545	57.1	107.1	106	1.1	6	★
5.50	VAPDMD0550	57.1	107.1	106	1.1	6	●
5.55	VAPDMD0555	57.2	107.2	106	1.2	6	★
5.60	VAPDMD0560	57.2	107.2	106	1.2	6	★
5.65	VAPDMD0565	57.2	107.2	106	1.2	6	★
5.70	VAPDMD0570	57.2	107.2	106	1.2	6	★
5.75	VAPDMD0575	57.2	107.2	106	1.2	6	★
5.80	VAPDMD0580	57.2	107.2	106	1.2	6	★
5.85	VAPDMD0585	57.2	107.2	106	1.2	6	★
5.90	VAPDMD0590	57.2	107.2	106	1.2	6	★
5.95	VAPDMD0595	57.2	107.2	106	1.2	6	★
6.00	VAPDMD0600	57.2	107.2	106	1.2	6	●
6.05	VAPDMD0605	63.3	113.3	112	1.3	8	★
6.10	VAPDMD0610	63.3	113.3	112	1.3	8	★
6.15	VAPDMD0615	63.3	113.3	112	1.3	8	★
6.20	VAPDMD0620	63.3	113.3	112	1.3	8	★
6.25	VAPDMD0625	63.3	113.3	112	1.3	8	★

DC (мм)	Обозначение	Размеры (мм)					Наличие
		LCF	OAL	LF	PL	DCON	
6.30	VAPDMD0630	63.3	113.3	112	1.3	8	★
6.35	VAPDMD0635	63.3	113.3	112	1.3	8	★
6.40	VAPDMD0640	63.3	113.3	112	1.3	8	★
6.45	VAPDMD0645	63.3	113.3	112	1.3	8	★
6.50	VAPDMD0650	63.4	113.4	112	1.4	8	●
6.55	VAPDMD0655	63.4	113.4	112	1.4	8	★
6.60	VAPDMD0660	63.4	113.4	112	1.4	8	★
6.65	VAPDMD0665	63.4	113.4	112	1.4	8	★
6.70	VAPDMD0670	63.4	113.4	112	1.4	8	★
6.75	VAPDMD0675	68.4	118.4	117	1.4	8	★
6.80	VAPDMD0680	68.4	118.4	117	1.4	8	★
6.85	VAPDMD0685	68.4	118.4	117	1.4	8	★
6.90	VAPDMD0690	68.4	118.4	117	1.4	8	★
6.95	VAPDMD0695	68.4	118.4	117	1.4	8	★
7.00	VAPDMD0700	68.5	118.5	117	1.5	8	●
7.05	VAPDMD0705	68.5	118.5	117	1.5	8	★
7.10	VAPDMD0710	68.5	118.5	117	1.5	8	★
7.15	VAPDMD0715	68.5	118.5	117	1.5	8	★
7.20	VAPDMD0720	68.5	118.5	117	1.5	8	★
7.25	VAPDMD0725	68.5	118.5	117	1.5	8	★
7.30	VAPDMD0730	68.5	118.5	117	1.5	8	★
7.35	VAPDMD0735	68.5	118.5	117	1.5	8	★
7.40	VAPDMD0740	68.5	118.5	117	1.5	8	★
7.45	VAPDMD0745	68.5	118.5	117	1.5	8	★
7.50	VAPDMD0750	68.6	118.6	117	1.6	8	●
7.55	VAPDMD0755	74.6	124.6	123	1.6	8	★
7.60	VAPDMD0760	74.6	124.6	123	1.6	8	★
7.65	VAPDMD0765	74.6	124.6	123	1.6	8	★
7.70	VAPDMD0770	74.6	124.6	123	1.6	8	★
7.75	VAPDMD0775	74.6	124.6	123	1.6	8	★
7.80	VAPDMD0780	74.6	124.6	123	1.6	8	★
7.85	VAPDMD0785	74.6	124.6	123	1.6	8	★
7.90	VAPDMD0790	74.6	124.6	123	1.6	8	★
7.95	VAPDMD0795	74.7	124.7	123	1.7	8	★
8.00	VAPDMD0800	74.7	124.7	123	1.7	8	●
8.05	VAPDMD0805	74.7	129.7	128	1.7	10	★
8.10	VAPDMD0810	74.7	129.7	128	1.7	10	★
8.15	VAPDMD0815	74.7	129.7	128	1.7	10	★
8.20	VAPDMD0820	74.7	129.7	128	1.7	10	★
8.25	VAPDMD0825	74.7	129.7	128	1.7	10	★
8.30	VAPDMD0830	74.7	129.7	128	1.7	10	★
8.35	VAPDMD0835	74.7	129.7	128	1.7	10	★
8.40	VAPDMD0840	74.7	129.7	128	1.7	10	★
8.45	VAPDMD0845	74.8	129.8	128	1.8	10	★
8.50	VAPDMD0850	74.8	129.8	128	1.8	10	●
8.55	VAPDMD0855	80.8	135.8	134	1.8	10	★
8.60	VAPDMD0860	80.8	135.8	134	1.8	10	★
8.65	VAPDMD0865	80.8	135.8	134	1.8	10	★
8.70	VAPDMD0870	80.8	135.8	134	1.8	10	★
8.75	VAPDMD0875	80.8	135.8	134	1.8	10	★

● : Есть на складе. ★ : Со склада в Японии.

DC (мм)	Обозначение	Размеры (мм)					Наличие
		LCF	OAL	LF	PL	DCON	
8.80	VAPDMD0880	80.8	135.8	134	1.8	10	★
8.85	VAPDMD0885	80.8	135.8	134	1.8	10	★
8.90	VAPDMD0890	80.8	135.8	134	1.8	10	★
8.95	VAPDMD0895	80.9	135.9	134	1.9	10	★
9.00	VAPDMD0900	80.9	135.9	134	1.9	10	●
9.10	VAPDMD0910	80.9	135.9	134	1.9	10	★
9.20	VAPDMD0920	80.9	135.9	134	1.9	10	★
9.30	VAPDMD0930	80.9	135.9	134	1.9	10	★
9.40	VAPDMD0940	81.0	136.0	134	2.0	10	★
9.50	VAPDMD0950	81.0	136.0	134	2.0	10	●
9.60	VAPDMD0960	87.0	142.0	140	2.0	10	★
9.70	VAPDMD0970	87.0	142.0	140	2.0	10	★
9.80	VAPDMD0980	87.0	142.0	140	2.0	10	★
9.90	VAPDMD0990	87.1	142.1	140	2.1	10	★
10.00	VAPDMD1000	87.1	142.1	140	2.1	10	●
10.10	VAPDMD1010	87.1	147.1	145	2.1	12	★
10.20	VAPDMD1020	87.1	147.1	145	2.1	12	★
10.30	VAPDMD1030	87.1	147.1	145	2.1	12	★
10.40	VAPDMD1040	87.2	147.2	145	2.2	12	★
10.50	VAPDMD1050	87.2	147.2	145	2.2	12	●
10.60	VAPDMD1060	87.2	147.2	145	2.2	12	★
10.70	VAPDMD1070	94.2	154.2	152	2.2	12	★
10.80	VAPDMD1080	94.2	154.2	152	2.2	12	★
10.90	VAPDMD1090	94.3	154.3	152	2.3	12	★
11.00	VAPDMD1100	94.3	154.3	152	2.3	12	●
11.10	VAPDMD1110	94.3	154.3	152	2.3	12	★
11.20	VAPDMD1120	94.3	154.3	152	2.3	12	★
11.30	VAPDMD1130	94.3	154.3	152	2.3	12	★
11.40	VAPDMD1140	94.4	154.4	152	2.4	12	★
11.50	VAPDMD1150	94.4	154.4	152	2.4	12	●
11.60	VAPDMD1160	94.4	154.4	152	2.4	12	★
11.70	VAPDMD1170	94.4	154.4	152	2.4	12	★
11.80	VAPDMD1180	94.4	154.4	152	2.4	12	★
11.90	VAPDMD1190	101.5	161.5	159	2.5	12	★
12.00	VAPDMD1200	101.5	161.5	159	2.5	12	●
12.10	VAPDMD1210	101.5	161.5	159	2.5	12	★
12.20	VAPDMD1220	101.5	161.5	159	2.5	12	★
12.30	VAPDMD1230	101.6	161.6	159	2.6	12	★
12.40	VAPDMD1240	101.6	161.6	159	2.6	12	★
12.50	VAPDMD1250	101.6	161.6	159	2.6	12	●
12.60	VAPDMD1260	101.6	161.6	159	2.6	12	★
12.70	VAPDMD1270	101.6	161.6	159	2.6	12	★
12.80	VAPDMD1280	101.7	161.7	159	2.7	12	★
12.90	VAPDMD1290	101.7	161.7	159	2.7	12	★
13.00	VAPDMD1300	101.7	161.7	159	2.7	12	●
13.50	VAPDMD1350	102.8	162.8	160	2.8	16	●
14.00	VAPDMD1400	102.9	162.9	160	2.9	16	●
14.10	VAPDMD1410	107.9	167.9	165	2.9	16	★
14.20	VAPDMD1420	107.9	167.9	165	2.9	16	★
14.50	VAPDMD1450	108.0	168.0	165	3.0	16	●
15.00	VAPDMD1500	108.1	168.1	165	3.1	16	●

DC (мм)	Обозначение	Размеры (мм)					Наличие
		LCF	OAL	LF	PL	DCON	
15.50	VAPDMD1550	113.2	173.2	170	3.2	16	★
15.60	VAPDMD1560	113.2	173.2	170	3.2	16	★
15.70	VAPDMD1570	113.3	173.3	170	3.3	16	★
16.00	VAPDMD1600	113.3	173.3	170	3.3	16	●
16.50	VAPDMD1650	113.4	178.4	175	3.4	20	●
17.00	VAPDMD1700	113.5	178.5	175	3.5	20	●
17.50	VAPDMD1750	118.6	183.6	180	3.6	20	●
17.60	VAPDMD1760	118.7	183.7	180	3.7	20	★
17.70	VAPDMD1770	118.7	183.7	180	3.7	20	★
18.00	VAPDMD1800	118.7	183.7	180	3.7	20	●
18.50	VAPDMD1850	123.8	188.8	185	3.8	20	★
19.00	VAPDMD1900	123.9	188.9	185	3.9	20	★
19.50	VAPDMD1950	124.0	189.0	185	4.0	20	★
19.60	VAPDMD1960	124.1	189.1	185	4.1	20	★
19.70	VAPDMD1970	124.1	189.1	185	4.1	20	★
20.00	VAPDMD2000	124.1	189.1	185	4.1	20	★
20.50	VAPDMD2050	129.3	204.3	200	4.3	25	●
21.00	VAPDMD2100	129.4	204.4	200	4.4	25	●
21.10	VAPDMD2110	129.4	204.4	200	4.4	25	★
21.20	VAPDMD2120	129.4	204.4	200	4.4	25	★
21.50	VAPDMD2150	129.5	204.5	200	4.5	25	★
22.00	VAPDMD2200	129.6	204.6	200	4.6	25	●
22.50	VAPDMD2250	134.7	209.7	205	4.7	25	★
23.00	VAPDMD2300	134.8	209.8	205	4.8	25	●
23.50	VAPDMD2350	134.9	209.9	205	4.9	25	★
24.00	VAPDMD2400	140.0	215.0	210	5.0	25	★
24.50	VAPDMD2450	140.1	215.1	210	5.1	25	★
25.00	VAPDMD2500	140.2	215.2	210	5.2	25	★
25.50	VAPDMD2550	145.3	225.3	220	5.3	32	●
26.00	VAPDMD2600	145.4	225.4	220	5.4	32	★
26.50	VAPDMD2650	145.5	225.5	220	5.5	32	★
27.00	VAPDMD2700	145.6	225.6	220	5.6	32	★
28.00	VAPDMD2800	145.8	225.8	220	5.8	32	★
29.00	VAPDMD2900	151.0	231.0	225	6.0	32	★
30.00	VAPDMD3000	151.2	231.2	225	6.2	32	★
31.00	VAPDMD3100	156.4	236.4	230	6.4	32	★
32.00	VAPDMD3200	161.6	241.6	235	6.6	32	★

M

ИНСТРУМЕНТ ДЛЯ
СВЕРЛЕНИЯ

РЕКОМЕНДУЕМЫЕ РЕЖИМЫ РЕЗАНИЯ (Стандартная глубина сверления : равна 5 диаметрам сверла или меньше)

Обработываемый материал	P		P	K	P	M	P	M
	Конструкционная сталь		Углеродистая сталь S _k 55 Легированная сталь 070M55 Чугун		Легированная инструментальная сталь X210Cr12 (Материалы низкой твердости) Ферритная нержавеющая сталь X10CrAl18, X10CrAl13 Мартенситная нержавеющая сталь X20Cr13, X10CrAl13		Легированная инструментальная сталь X40CrMoV51 (-40HRC) Нержавеющая сталь с дисперсионным упрочнением X7CrNiAl177	
Диам. сверла DC (мм)	Частота вращения (мин ⁻¹)	Подача (мм/об)	Частота вращения (мин ⁻¹)	Подача (мм/об)	Частота вращения (мин ⁻¹)	Подача (мм/об)	Частота вращения (мин ⁻¹)	Подача (мм/об)
0.5	17000	0.01	12800	0.01	8000	0.01	6600	0.01
1.0	11000	0.05	8300	0.05	5000	0.05	4100	0.04
2.0	6400	0.09	4800	0.09	2900	0.06	2400	0.05
3.0	4300	0.13	3200	0.13	1900	0.10	1600	0.06
4.0	3200	0.15	2400	0.15	1400	0.10	1200	0.08
5.0	2600	0.18	1900	0.18	1100	0.13	950	0.10
6.0	2100	0.19	1600	0.20	950	0.15	800	0.11
8.0	1600	0.24	1200	0.22	720	0.18	600	0.13
10.0	1300	0.28	950	0.25	570	0.21	480	0.15
12.0	1100	0.34	800	0.30	480	0.25	400	0.17
14.0	910	0.39	680	0.35	410	0.30	340	0.21
15.0	850	0.40	640	0.36	380	0.31	320	0.22
16.0	800	0.42	600	0.38	360	0.32	300	0.23
18.0	710	0.44	530	0.40	320	0.34	270	0.24
20.0	570	0.44	450	0.40	250	0.34	220	0.24
22.0	520	0.46	410	0.42	230	0.36	200	0.25
24.0	480	0.48	370	0.44	210	0.37	190	0.26
26.0	440	0.51	340	0.46	200	0.39	170	0.28
28.0	410	0.53	320	0.48	180	0.41	160	0.29
30.0	380	0.55	300	0.50	170	0.43	150	0.30
32.0	360	0.55	280	0.50	160	0.43	140	0.30

Примечание 1) Пожалуйста, снизьте обороты и подачу при недостаточной жесткости закрепленной детали или ограничениях станка.

Примечание 2) Пожалуйста, используйте сверлильную или фрезерную оправку цангового типа.

Примечание 3) Используйте достаточное количество СОЖ.

Примечание 4) При сверлении отверстий глубиной более 4 x DC сверла, используйте подачу с периодическим выводом сверла из отверстия.

Примечание 5) Вышеупомянутые режимы резания указаны для обработки с СОЖ.

Пожалуйста, снизьте обороты при обработке без СОЖ.

M

ИНСТРУМЕНТ ДЛЯ
СВЕРЛЕНИЯ



DC<0.7

DC≥0.7

DC<2

DC≥2

P M K N S H

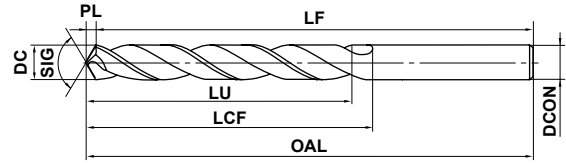

*LU = LCF-2DC



0.5≤DC≤1	1≤DC≤3	3<DC≤6	6<DC≤10	10<DC≤13
0 -0.010	0 -0.014	0 -0.018	0 -0.022	0 -0.027

DC (мм)	Обозначение	Размеры (мм)					Наличие
		LCF	OAL	LF	PL	DCON	
0.5	VSDD0050	6.2	27.2	27	0.18	0.5	★
0.6	VSDD0060	7.2	30.2	30	0.21	0.6	●
0.7	VSDD0070	9.2	32.2	32	0.21	0.7	●
0.8	VSDD0080	10.2	34.2	34	0.24	0.8	●
0.9	VSDD0090	11.3	36.3	36	0.27	0.9	●
1.0	VSDD0100	12.3	40.3	40	0.3	1.0	●
1.1	VSDD0110	14.3	42.3	42	0.3	1.1	●
1.2	VSDD0120	16.4	42.4	42	0.4	1.2	●
1.3	VSDD0130	16.4	45.4	45	0.4	1.3	●
1.4	VSDD0140	18.4	48.4	48	0.4	1.4	●
1.5	VSDD0150	18.5	48.5	48	0.5	1.5	●
1.6	VSDD0160	20.5	50.5	50	0.5	1.6	●
1.7	VSDD0170	20.5	50.5	50	0.5	1.7	★
1.8	VSDD0180	22.5	52.5	52	0.5	1.8	●
1.9	VSDD0190	22.6	52.6	52	0.6	1.9	●
2.0	VSDD0200	23.6	55.6	55	0.6	2.0	●
2.1	VSDD0210	23.6	55.6	55	0.6	2.1	●
2.2	VSDD0220	26.7	58.7	58	0.7	2.2	●
2.3	VSDD0230	26.7	58.7	58	0.7	2.3	★
2.4	VSDD0240	29.7	61.7	61	0.7	2.4	★
2.5	VSDD0250	29.8	61.8	61	0.8	2.5	●
2.6	VSDD0260	29.8	64.8	64	0.8	2.6	★
2.7	VSDD0270	32.8	64.8	64	0.8	2.7	★
2.8	VSDD0280	32.8	67.8	67	0.8	2.8	●
2.9	VSDD0290	32.9	71.9	71	0.9	2.9	★
3.0	VSDD0300	32.9	71.9	71	0.9	3.0	●
3.1	VSDD0310	35.9	71.9	71	0.9	3.1	●
3.2	VSDD0320	36.0	72.0	71	1.0	3.2	●
3.3	VSDD0330	36.0	74.0	73	1.0	3.3	●
3.4	VSDD0340	39.0	74.0	73	1.0	3.4	●
3.5	VSDD0350	39.1	74.1	73	1.1	3.5	●
3.6	VSDD0360	39.1	77.1	76	1.1	3.6	★
3.7	VSDD0370	39.1	77.1	76	1.1	3.7	★
3.8	VSDD0380	43.1	77.1	76	1.1	3.8	★
3.9	VSDD0390	43.2	80.2	79	1.2	3.9	★
4.0	VSDD0400	43.2	84.2	83	1.2	4.0	●
4.1	VSDD0410	43.2	84.2	83	1.2	4.1	●
4.2	VSDD0420	43.3	84.3	83	1.3	4.2	●
4.3	VSDD0430	47.3	84.3	83	1.3	4.3	●
4.4	VSDD0440	47.3	87.3	86	1.3	4.4	★

DC (мм)	Обозначение	Размеры (мм)					Наличие
		LCF	OAL	LF	PL	DCON	
4.5	VSDD0450	47.4	87.4	86	1.4	4.5	●
4.6	VSDD0460	47.4	87.4	86	1.4	4.6	★
4.7	VSDD0470	47.4	90.4	89	1.4	4.7	★
4.8	VSDD0480	52.4	90.4	89	1.4	4.8	●
4.9	VSDD0490	52.5	93.5	92	1.5	4.9	★
5.0	VSDD0500	52.5	93.5	92	1.5	5.0	●
5.1	VSDD0510	52.5	93.5	92	1.5	5.1	●
5.2	VSDD0520	52.6	96.6	95	1.6	5.2	●
5.3	VSDD0530	52.6	96.6	95	1.6	5.3	★
5.4	VSDD0540	57.6	96.6	95	1.6	5.4	★
5.5	VSDD0550	57.7	96.7	95	1.7	5.5	●
5.6	VSDD0560	57.7	99.7	98	1.7	5.6	★
5.7	VSDD0570	57.7	99.7	98	1.7	5.7	★
5.8	VSDD0580	57.7	99.7	98	1.7	5.8	★
5.9	VSDD0590	57.8	99.8	98	1.8	5.9	●
6.0	VSDD0600	57.8	103.8	102	1.8	6.0	●
6.1	VSDD0610	63.8	103.8	102	1.8	6.1	★
6.2	VSDD0620	63.9	103.9	102	1.9	6.2	●
6.3	VSDD0630	63.9	103.9	102	1.9	6.3	●
6.4	VSDD0640	63.9	106.9	105	1.9	6.4	★
6.5	VSDD0650	64.0	107.0	105	2.0	6.5	●
6.6	VSDD0660	64.0	107.0	105	2.0	6.6	★
6.7	VSDD0670	64.0	107.0	105	2.0	6.7	★
6.8	VSDD0680	69.0	107.0	105	2.0	6.8	●
6.9	VSDD0690	69.1	107.1	105	2.1	6.9	★
7.0	VSDD0700	69.1	107.1	105	2.1	7.0	●
7.1	VSDD0710	69.1	110.1	108	2.1	7.1	★
7.2	VSDD0720	69.2	110.2	108	2.2	7.2	★
7.3	VSDD0730	69.2	110.2	108	2.2	7.3	●
7.4	VSDD0740	69.2	113.2	111	2.2	7.4	★
7.5	VSDD0750	69.3	113.3	111	2.3	7.5	★
7.6	VSDD0760	75.3	113.3	111	2.3	7.6	★
7.7	VSDD0770	75.3	116.3	114	2.3	7.7	★
7.8	VSDD0780	75.3	116.3	114	2.3	7.8	★
7.9	VSDD0790	75.4	116.4	114	2.4	7.9	●
8.0	VSDD0800	75.4	116.4	114	2.4	8.0	●
8.1	VSDD0810	75.4	119.4	117	2.4	8.1	★
8.2	VSDD0820	75.5	119.5	117	2.5	8.2	★
8.3	VSDD0830	75.5	119.5	117	2.5	8.3	★
8.4	VSDD0840	75.5	123.5	121	2.5	8.4	★

Примечание 1) Менее ø5-ø1,9 мм: 5 шт. в упаковке, больше ø2 мм: 1 шт. в упаковке.

● : Есть на складе. ★ : Со склада в Японии.

DC (мм)	Обозначение	Размеры (мм)					Наличие
		LCF	OAL	LF	PL	DCON	
8.5	VSDD0850	75.6	123.6	121	2.6	8.5	●
8.6	VSDD0860	81.6	123.6	121	2.6	8.6	●
8.7	VSDD0870	81.6	123.6	121	2.6	8.7	●
8.8	VSDD0880	81.6	126.6	124	2.6	8.8	★
8.9	VSDD0890	81.7	126.7	124	2.7	8.9	★
9.0	VSDD0900	81.7	126.7	124	2.7	9.0	●
9.1	VSDD0910	81.7	126.7	124	2.7	9.1	★
9.2	VSDD0920	81.8	129.8	127	2.8	9.2	★
9.3	VSDD0930	81.8	129.8	127	2.8	9.3	★
9.4	VSDD0940	81.8	129.8	127	2.8	9.4	★
9.5	VSDD0950	81.9	129.9	127	2.9	9.5	●
9.6	VSDD0960	87.9	132.9	130	2.9	9.6	★
9.7	VSDD0970	87.9	132.9	130	2.9	9.7	★
9.8	VSDD0980	87.9	132.9	130	2.9	9.8	★
9.9	VSDD0990	88.0	133.0	130	3.0	9.9	★
10.0	VSDD1000	88.0	133.0	130	3.0	10.0	●
10.1	VSDD1010	88.0	136.0	133	3.0	10.1	★
10.2	VSDD1020	88.1	136.1	133	3.1	10.2	●
10.3	VSDD1030	88.1	136.1	133	3.1	10.3	●
10.4	VSDD1040	88.1	136.1	133	3.1	10.4	★
10.5	VSDD1050	88.2	140.2	137	3.2	10.5	●
10.6	VSDD1060	88.2	140.2	137	3.2	10.6	★
10.7	VSDD1070	95.2	140.2	137	3.2	10.7	★

DC (мм)	Обозначение	Размеры (мм)					Наличие
		LCF	OAL	LF	PL	DCON	
10.8	VSDD1080	95.2	143.2	140	3.2	10.8	★
10.9	VSDD1090	95.3	143.3	140	3.3	10.9	★
11.0	VSDD1100	95.3	143.3	140	3.3	11.0	●
11.1	VSDD1110	95.3	143.3	140	3.3	11.1	★
11.2	VSDD1120	95.4	146.4	143	3.4	11.2	★
11.3	VSDD1130	95.4	146.4	143	3.4	11.3	★
11.4	VSDD1140	95.4	146.4	143	3.4	11.4	★
11.5	VSDD1150	95.5	146.5	143	3.5	11.5	★
11.6	VSDD1160	95.5	149.5	146	3.5	11.6	★
11.7	VSDD1170	95.5	149.5	146	3.5	11.7	★
11.8	VSDD1180	95.5	149.5	146	3.5	11.8	★
11.9	VSDD1190	102.6	149.6	146	3.6	11.9	★
12.0	VSDD1200	102.6	152.6	149	3.6	12.0	●
12.1	VSDD1210	102.6	152.6	149	3.6	12.1	★
12.2	VSDD1220	102.7	152.7	149	3.7	12.2	★
12.3	VSDD1230	102.7	152.7	149	3.7	12.3	★
12.4	VSDD1240	102.7	155.7	152	3.7	12.4	★
12.5	VSDD1250	102.8	155.8	152	3.8	12.5	★
12.6	VSDD1260	102.8	155.8	152	3.8	12.6	★
12.7	VSDD1270	102.8	155.8	152	3.8	12.7	★
12.8	VSDD1280	102.8	155.8	152	3.8	12.8	★
12.9	VSDD1290	102.9	155.9	152	3.9	12.9	★
13.0	VSDD1300	102.9	155.9	152	3.9	13.0	●

РЕКОМЕНДУЕМЫЕ РЕЖИМЫ РЕЗАНИЯ

Обрабатываемый материал	P		M		P		M	
	Конструкционная сталь		Углеродистая сталь Ck55		Нержавеющая сталь X20Cr13		Нержавеющая сталь X5CrNi1810 Инструментальная сталь X210Cr12 (Материалы низкой твердости) Термообработанные стали X40CrMoV51 (-40HRC)	
Скорость резания	40м/мин		30м/мин		20м/мин		10-14м/мин	
Диам. сверла DC (мм)	Частота вращения (мин ⁻¹)	Подача (мм/об)	Частота вращения (мин ⁻¹)	Подача (мм/об)	Частота вращения (мин ⁻¹)	Подача (мм/об)	Частота вращения (мин ⁻¹)	Подача (мм/об)
0.5	15000	0.01	11250	0.01	7500	0.01	5620	0.01
1.0	10000	0.02	7500	0.02	5000	0.02	3750	0.02
1.5	8200	0.03	6150	0.03	4100	0.03	2800	0.03
2.0	6370	0.05	4780	0.05	3180	0.05	2200	0.04
3.0	4250	0.10	3180	0.10	2120	0.07	1400	0.06
4.0	3180	0.13	2390	0.13	1590	0.09	1100	0.08
5.0	2550	0.15	1910	0.15	1270	0.11	860	0.10
6.0	2120	0.18	1590	0.18	1060	0.13	720	0.11
7.0	1820	0.20	1360	0.20	910	0.14	610	0.12
8.0	1590	0.22	1190	0.21	800	0.15	540	0.13
9.0	1420	0.24	1060	0.22	710	0.17	480	0.14
10.0	1270	0.26	960	0.23	640	0.18	430	0.15
11.0	1160	0.28	870	0.24	580	0.19	390	0.16
12.0	1060	0.30	800	0.25	530	0.20	360	0.17
13.0	980	0.30	730	0.26	490	0.20	330	0.17

Примечание 1) Пожалуйста, снизьте обороты при недостаточной жесткости закрепленной детали.

Примечание 2) Вышеупомянутые режимы резания указаны для обработки с СОЖ.

Пожалуйста, снизьте обороты при обработке без СОЖ.

VAPDSCB

Короткая длина рабочей части, высокая точность, для зенкования



Быстрорежущая
сталь

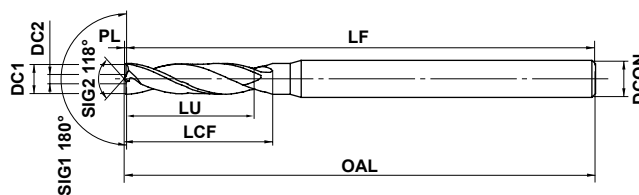

*LU = LCF - 2DC (не более 3×DC)



DC ≤ 3	3 < DC ≤ 6	6 < DC ≤ 10	10 < DC ≤ 18	18 < DC ≤ 30	30 < DC ≤ 32
0	0	0	0	0	0
-0.014	-0.018	-0.022	-0.027	-0.033	-0.039

- Уникальная геометрия для высокоэффективного рассверливания. Хорошее стружкодробление и качество поверхности после рассверливания.

DC1 (мм)	Обозначение	Размеры (мм)						Наличие
		DC2	LCF	OAL	LF	PL	DCON	
2.0	VAPDSCBD0200	0.7	12	60.2	60	0.2	3	★
2.1	VAPDSCBD0210	0.7	12	60.2	60	0.2	3	★
2.2	VAPDSCBD0220	0.7	12	60.2	60	0.2	3	★
2.3	VAPDSCBD0230	0.7	13	60.2	60	0.2	3	★
2.4	VAPDSCBD0240	0.7	13	60.2	60	0.2	3	★
2.5	VAPDSCBD0250	0.7	13	60.2	60	0.2	3	★
2.6	VAPDSCBD0260	0.8	15	60.2	60	0.2	3	★
2.7	VAPDSCBD0270	0.8	15	60.2	60	0.2	3	★
2.8	VAPDSCBD0280	0.8	15	60.2	60	0.2	3	★
2.9	VAPDSCBD0290	0.8	15	60.2	60	0.2	3	★
3.0	VAPDSCBD0300	0.8	15	60.2	60	0.2	3	★
3.1	VAPDSCBD0310	0.8	17	70.2	70	0.2	4	★
3.2	VAPDSCBD0320	0.8	17	70.2	70	0.2	4	★
3.3	VAPDSCBD0330	0.8	19	70.2	70	0.2	4	★
3.4	VAPDSCBD0340	0.8	19	70.2	70	0.2	4	★
3.5	VAPDSCBD0350	0.8	19	70.2	70	0.2	4	★
3.6	VAPDSCBD0360	1.0	21	70.2	70	0.2	4	★
3.7	VAPDSCBD0370	1.0	21	70.2	70	0.2	4	★
3.8	VAPDSCBD0380	1.0	21	70.2	70	0.2	4	★
3.9	VAPDSCBD0390	1.0	21	70.2	70	0.2	4	★
4.0	VAPDSCBD0400	1.0	21	70.3	70	0.3	4	★
4.1	VAPDSCBD0410	1.0	21	80.3	80	0.3	6	★
4.2	VAPDSCBD0420	1.0	21	80.3	80	0.3	6	★
4.3	VAPDSCBD0430	1.0	23	80.3	80	0.3	6	★
4.4	VAPDSCBD0440	1.0	23	80.3	80	0.3	6	★
4.5	VAPDSCBD0450	1.0	23	80.3	80	0.3	6	★
4.6	VAPDSCBD0460	1.4	25	80.3	80	0.3	6	★
4.7	VAPDSCBD0470	1.4	25	80.3	80	0.3	6	★
4.8	VAPDSCBD0480	1.4	25	80.3	80	0.3	6	★
4.9	VAPDSCBD0490	1.4	25	80.3	80	0.3	6	★
5.0	VAPDSCBD0500	1.4	25	80.4	80	0.4	6	★
5.1	VAPDSCBD0510	1.4	25	80.4	80	0.4	6	★
5.2	VAPDSCBD0520	1.4	25	80.4	80	0.4	6	★
5.3	VAPDSCBD0530	1.4	25	80.4	80	0.4	6	★
5.4	VAPDSCBD0540	1.4	27	80.4	80	0.4	6	★
5.5	VAPDSCBD0550	1.4	27	80.4	80	0.4	6	★
5.6	VAPDSCBD0560	1.4	27	80.4	80	0.4	6	★
5.7	VAPDSCBD0570	1.4	27	80.4	80	0.4	6	★
5.8	VAPDSCBD0580	1.4	27	80.4	80	0.4	6	★
5.9	VAPDSCBD0590	1.4	27	80.4	80	0.4	6	★

DC1 (мм)	Обозначение	Размеры (мм)						Наличие
		DC2	LCF	OAL	LF	PL	DCON	
6.0	VAPDSCBD0600	1.4	27	80.4	80	0.4	6	★
6.1	VAPDSCBD0610	1.4	30	80.4	80	0.4	8	★
6.2	VAPDSCBD0620	1.4	30	80.4	80	0.4	8	★
6.3	VAPDSCBD0630	1.4	30	80.4	80	0.4	8	★
6.4	VAPDSCBD0640	1.4	30	80.4	80	0.4	8	★
6.5	VAPDSCBD0650	1.4	30	80.4	80	0.4	8	★
6.6	VAPDSCBD0660	1.8	30	80.4	80	0.4	8	★
6.7	VAPDSCBD0670	1.8	30	80.4	80	0.4	8	★
6.8	VAPDSCBD0680	1.8	32	80.4	80	0.4	8	★
6.9	VAPDSCBD0690	1.8	32	80.4	80	0.4	8	★
7.0	VAPDSCBD0700	1.8	32	80.6	80	0.6	8	★
7.1	VAPDSCBD0710	1.8	32	80.6	80	0.6	8	★
7.2	VAPDSCBD0720	1.8	32	80.6	80	0.6	8	★
7.3	VAPDSCBD0730	1.8	32	80.6	80	0.6	8	★
7.4	VAPDSCBD0740	1.8	32	80.6	80	0.6	8	★
7.5	VAPDSCBD0750	1.8	32	80.6	80	0.6	8	★
7.6	VAPDSCBD0760	2.0	35	85.6	85	0.6	8	★
7.7	VAPDSCBD0770	2.0	35	85.6	85	0.6	8	★
7.8	VAPDSCBD0780	2.0	35	85.6	85	0.6	8	★
7.9	VAPDSCBD0790	2.0	35	85.6	85	0.6	8	★
8.0	VAPDSCBD0800	2.0	35	85.6	85	0.6	8	★
8.1	VAPDSCBD0810	2.0	35	90.6	90	0.6	10	★
8.5	VAPDSCBD0850	2.0	35	90.6	90	0.6	10	★
8.6	VAPDSCBD0860	2.8	38	93.6	93	0.6	10	★
8.8	VAPDSCBD0880	2.8	38	93.6	93	0.6	10	★
9.0	VAPDSCBD0900	2.8	38	93.8	93	0.8	10	★
9.1	VAPDSCBD0910	2.8	38	93.8	93	0.8	10	★
9.5	VAPDSCBD0950	2.8	38	93.8	93	0.8	10	★
9.6	VAPDSCBD0960	3.2	41	96.8	96	0.8	10	★
9.8	VAPDSCBD0980	3.2	41	96.8	96	0.8	10	★
10.0	VAPDSCBD1000	3.2	41	96.9	96	0.9	10	★
10.1	VAPDSCBD1010	3.2	41	101.9	101	0.9	12	★
10.3	VAPDSCBD1030	3.2	41	101.9	101	0.9	12	★
10.5	VAPDSCBD1050	3.2	41	101.9	101	0.9	12	★
10.8	VAPDSCBD1080	3.7	45	105.9	105	0.9	12	★
11.0	VAPDSCBD1100	3.7	45	105.9	105	0.9	12	★
11.1	VAPDSCBD1110	3.7	45	105.9	105	0.9	12	★
11.5	VAPDSCBD1150	3.7	45	105.9	105	0.9	12	★
11.8	VAPDSCBD1180	3.7	45	105.9	105	0.9	12	★
12.0	VAPDSCBD1200	3.7	49	109.9	109	0.9	12	★

М
ИНСТРУМЕНТ ДЛЯ
СВЕРЛЕНИЯ

★ : Со склада в Японии.

РЕЖИМЫ РЕЗАНИЯ > M187
ТЕХНИЧЕСКИЕ ДАННЫЕ > P001

M185

VAPDSCB

Короткая длина рабочей части, высокая точность, для зенкования

Быстрорежущая
сталь

M

ИНСТРУМЕНТ ДЛЯ
СВЕРЛЕНИЯ

DC1 (мм)	Обозначение	Размеры (мм)						Наличие
		DC2	LCF	OAL	LF	PL	DCON	
12.5	VAPDSCBD1250	3.7	49	109.9	109	0.9	12	★
13.0	VAPDSCBD1300	4.2	49	110.1	109	1.1	12	★
13.5	VAPDSCBD1350	4.2	51	122.1	121	1.1	16	★
13.8	VAPDSCBD1380	4.2	51	122.1	121	1.1	16	★
14.0	VAPDSCBD1400	4.2	51	122.1	121	1.1	16	★
14.1	VAPDSCBD1410	5.5	58	124.1	123	1.1	16	★
14.2	VAPDSCBD1420	5.5	58	124.1	123	1.1	16	★
14.5	VAPDSCBD1450	5.5	58	124.1	123	1.1	16	★
14.8	VAPDSCBD1480	5.5	58	124.1	123	1.1	16	★
15.0	VAPDSCBD1500	5.5	58	124.3	123	1.3	16	★
15.5	VAPDSCBD1550	5.5	60	126.3	125	1.3	16	★
15.7	VAPDSCBD1570	5.5	60	126.3	125	1.3	16	★
15.8	VAPDSCBD1580	5.5	60	126.3	125	1.3	16	★
16.0	VAPDSCBD1600	5.5	60	126.3	125	1.3	16	★
17.0	VAPDSCBD1700	5.5	62	133.3	132	1.3	20	★
17.5	VAPDSCBD1750	5.5	63	134.6	133	1.6	20	★
17.6	VAPDSCBD1760	6.5	63	134.6	133	1.6	20	★
17.7	VAPDSCBD1770	6.5	63	134.6	133	1.6	20	★
17.8	VAPDSCBD1780	6.5	63	134.6	133	1.6	20	★
18.0	VAPDSCBD1800	6.5	63	134.6	133	1.6	20	★
18.1	VAPDSCBD1810	6.5	65	136.6	135	1.6	20	★
19.0	VAPDSCBD1900	6.5	65	136.6	135	1.6	20	★
19.8	VAPDSCBD1980	7.5	67	138.6	137	1.6	20	★
20.0	VAPDSCBD2000	7.5	67	138.8	137	1.8	20	★
20.1	VAPDSCBD2010	7.5	67	138.8	137	1.8	20	★
21.0	VAPDSCBD2100	7.5	75	166.8	165	1.8	25	★
22.0	VAPDSCBD2200	7.5	75	166.8	165	1.8	25	★
23.0	VAPDSCBD2300	7.5	80	171.8	170	1.8	25	★
24.0	VAPDSCBD2400	8.5	80	172.2	170	2.2	25	★
25.0	VAPDSCBD2500	8.5	85	182.2	180	2.2	25	★
26.0	VAPDSCBD2600	9.0	85	182.2	180	2.2	32	★
27.0	VAPDSCBD2700	9.0	95	192.2	190	2.2	32	★
28.0	VAPDSCBD2800	10.0	95	192.6	190	2.6	32	★
29.0	VAPDSCBD2900	10.0	100	197.6	195	2.6	32	★
30.0	VAPDSCBD3000	11.0	100	197.6	195	2.6	32	★
31.0	VAPDSCBD3100	11.0	105	202.6	200	2.6	32	★
32.0	VAPDSCBD3200	13.0	105	202.6	200	2.6	32	★

★ : Со склада в Японии.

РЕКОМЕНДУЕМЫЕ РЕЖИМЫ РЕЗАНИЯ

Обрабатываемый материал	P		N		P		M	
	Конструкционная сталь, Алюминиевые сплавы	Углеродистая сталь Сk55, Легированная сталь 070M55, Ковкий чугун	Легированная инструментальная сталь, X210Cr12 (Материалы низкой твердости) Ферритная нержавеющая сталь, X10CrAl18, X10CrAl13 Мартенситная нержавеющая сталь, X20Cr13, X10CrAl13	Легированная инструментальная сталь, X40CrMoV51 (-40HRC) Нержавеющая сталь с дисперсионным упрочнением, X7CrNiAl177				
Дiam. сверла DC (мм)	Частота вращения (мин ⁻¹)	Подача (мм/об)	Частота вращения (мин ⁻¹)	Подача (мм/об)	Частота вращения (мин ⁻¹)	Подача (мм/об)	Частота вращения (мин ⁻¹)	Подача (мм/об)
2.0	5600	0.07	4800	0.07	3200	0.07	2800	0.04
3.0	3700	0.10	3200	0.10	2100	0.10	1900	0.05
4.0	2800	0.12	2400	0.12	1600	0.12	1400	0.06
5.0	2200	0.14	1900	0.14	1300	0.14	1150	0.07
6.0	1850	0.15	1600	0.15	1050	0.15	950	0.08
8.0	1400	0.20	1200	0.20	800	0.20	720	0.10
10.0	1100	0.23	960	0.23	640	0.21	570	0.11
12.0	950	0.26	800	0.26	530	0.24	470	0.12
14.0	800	0.27	680	0.27	450	0.25	410	0.13
16.0	700	0.28	500	0.28	360	0.26	300	0.14
18.0	620	0.29	450	0.29	320	0.27	260	0.15
20.0	560	0.30	400	0.30	290	0.27	240	0.15
22.0	510	0.32	360	0.32	260	0.29	220	0.16
24.0	460	0.33	330	0.33	240	0.30	200	0.16
26.0	430	0.35	310	0.35	220	0.31	180	0.17
28.0	400	0.36	290	0.36	210	0.33	170	0.18
30.0	370	0.37	270	0.37	190	0.34	160	0.18
32.0	350	0.38	250	0.38	180	0.35	150	0.19

Примечание 1) Представленные выше параметры резания предназначены для сверления отверстий глубиной до DCx3 без направляющего отверстия. При сверлении отверстий глубиной менее DCx1 число оборотов можно повысить на 20 %.

Примечание 2) Рекомендуется сверление без направляющего отверстия. Отвод стружки может быть затруднён, если предварительно просверлено направляющее отверстие. Используйте режим подачи сверла с периодическим отводом из отверстия, если отвод стружки затруднён.

Примечание 3) Для рассверливания наклонной поверхности рекомендуются монолитные твердосплавные концевые фрезы.

Примечание 4) При обработке аустенитных нержавеющих сталей (типа X5CrNi1810) скорость вращения шпинделя следует снизить на 30 - 60%, а скорость подачи - на 40 - 60%.

Примечание 5) Для закрепления используйте цанговые патроны.







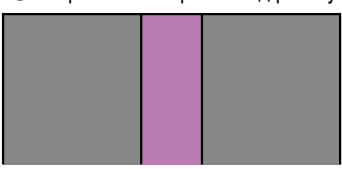

Примечание 6) Уменьшайте число оборотов и подачу в зависимости от условий сверления, например, если системе не хватает жёсткости.

Примечание 7) Применяйте достаточное количество СОЖ. Приведенные выше параметры резания являются ориентировочными при использовании водорастворимой СОЖ.

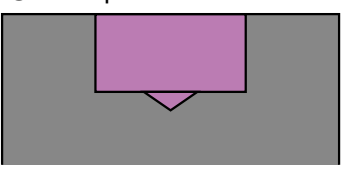
Примечание 8) Уменьшите число оборотов при использовании водонерастворимой СОЖ.

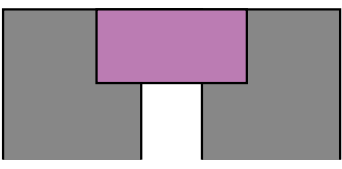
РЕКОМЕНДУЕМАЯ ПОСЛЕДОВАТЕЛЬНОСТЬ ОБРАБОТКИ

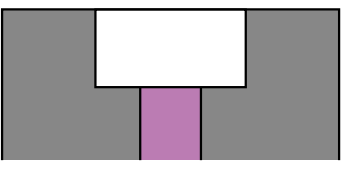
■ VAPDSCB обеспечивает высокоэффективную обработку с хорошим контролем стружки.

Общий метод обработки		Метод обработки при помощи серии VAPDSCB	
<p>①Сверление отверстий под резьбу</p> 	<p>Геометрия стружки</p>  <p>Хорошая</p>	<p>①Зенкерование</p> 	<p>Геометрия стружки</p>  <p>Хорошая</p>
<p>②Зенкерование</p> 	<p>Геометрия стружки</p>  <p>Слишком длинная стружка</p>	<p>②Сверление отверстий под резьбу</p> 	<p>Геометрия стружки</p>  <p>Хорошая</p>

Примечание 1) При рассверливании свёрлами VAPDSCB и использовании направляющих отверстий возможно возникновение сливной стружки, которая может наматываться на инструмент.

M

ИНСТРУМЕНТ ДЛЯ
СВЕРЛЕНИЯ

ИНСТРУМЕНТ ДЛЯ СВЕРЛЕНИЯ (МОНОЛИТНЫЕ ТВЕРДОСПЛАВНЫЕ СВЕРЛА)

ТВЕРДЫЙ
СПЛАВ

MCC



P M K N S H **CFRP**



Станок с ЧПУ

×

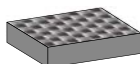

CFRP

M

Наружное охлаждение

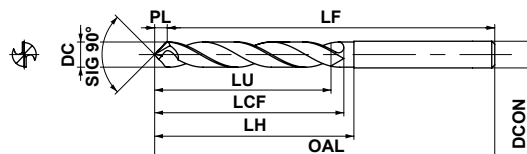

	3<DC≤6	6<DC≤10	10<DC≤18	18<DC≤20
	0 -0.018	0 -0.022	0 -0.027	0 -0.033
	DCON=6	6<DCON≤10	10<DCON≤12	
	0 -0.008	0 -0.009	0 -0.011	

Диам. отверстием		Диам. сверла		Глубина сверления (L/D)	Обозначение	Сплав DD2105	Размеры (мм)						
* AWG	дюйм	DC (мм)	дюйм				LU	LCF	LH	OAL	LF	PL	DCON
—	3/16	4.76	.1875	3	MCC0476X03S060	★	16.7	40	40	80	77.6	2.4	6
—	1/4	6.38	.251	3	MCC0638X03S080	★	22.3	50	50	90	86.8	3.2	8
—	5/16	7.96	.3125	3	MCC0796X03S080	★	27.9	50	50	90	86.0	4.0	8
—	3/8	9.55	.375	3	MCC0955X03S100	★	33.5	50	50	100	95.2	4.8	10
—	7/16	11.14	.4375	3	MCC1114X03S120	★	39.0	60	60	110	104.4	5.6	12

*AWG : Американская мера измерения диаметра

РЕКОМЕНДУЕМЫЕ РЕЖИМЫ РЕЗАНИЯ

Обрабатываемый материал		X				
		CFRP				
Диам. сверла DC (мм)	Диам. сверла DC (дюйм)	Скорость резания (м/мин)	Частота вращения (мин ⁻¹)	Подача (Мин.—Макс.) (мм/об)	Подача (мм/мин)	
4.76	.1875	100	6700	0.08 (0.05—0.12)	540	
6.38	.251	100	5000	0.1 (0.05—0.12)	500	
7.96	.3125	100	4000	0.1 (0.05—0.12)	400	
9.55	.375	100	3400	0.1 (0.05—0.12)	340	
11.14	.4375	100	2900	0.1 (0.05—0.12)	290	

★ : Со склада в Японии. □ : Нет на складе, выпускается исключительно под заказ.

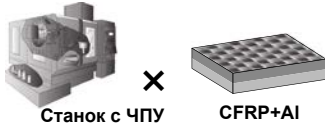

Внутреннее охлаждение

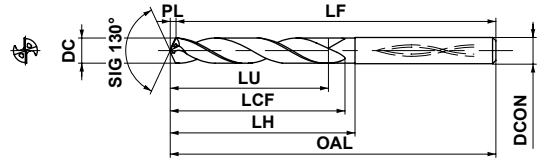

	$6 < DC \leq 10$
	0 -0.022
	$6 < DCON \leq 10$
	0 -0.009

Диам. отверстием		Диам. сверла		Глубина сверления (L/D)	Обозначение	Сплав	Размеры (мм)						
AWG*	дюйм	DC (мм)	дюйм				DD2110	LU	LCF	LH	OAL	LF	PL
—	1/4	6.38	.251	5	MCA0638X05S070	<input type="checkbox"/>	33.4	51	51	91	89.5	1.5	7
—	3/8	9.55	.375	5	MCA0955X05S100	<input type="checkbox"/>	50.0	77	77	118	115.8	2.2	10

*AWG : Американская мера измерения диаметра

РЕКОМЕНДУЕМЫЕ РЕЖИМЫ РЕЗАНИЯ

Обрабатываемый материал		X				N			
		CFRP				Алюминиевые сплавы (Si<5%) ASTM A6061, ASTM A7075 etc			
Диам. сверла DC (мм)	Диам. сверла DC (дюйм)	Скорость резания (м/мин)	Частота вращения (мин ⁻¹)	Подача (Мин.—Макс.) (мм/об)	Подача (мм/мин)	Скорость резания (м/мин)	Частота вращения (мин ⁻¹)	Подача (Мин.—Макс.) (мм/об)	Подача (мм/мин)
6.38	.251	100	5000	0.15 (0.10—0.20)	750	100	5000	0.03 (0.02—0.04)	150
9.55	.375	100	3400	0.15 (0.10—0.20)	680	100	3400	0.03 (0.02—0.04)	100

Примечание 1) Мы рекомендуем определить условия резания для каждого обрабатываемого материала в отдельности.

ИНСТРУМЕНТ ДЛЯ СВЕРЛЕНИЯ (МОНОЛИТНЫЕ ТВЕРДОСПЛАВНЫЕ СВЕРЛА)

ТВЕРДЫЙ СПЛАВ

MCT



P M K N **S** H CFRP+Ti



Станок с ЧПУ

×

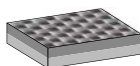

CFRP+Ti

M

Внутреннее охлаждение

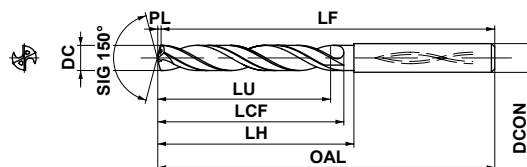

	$6 < DC \leq 10$
	$\begin{matrix} 0 \\ -0.022 \end{matrix}$
	$6 < DCON \leq 10$
	$\begin{matrix} 0 \\ -0.009 \end{matrix}$

Диам. отверстием		Диам. сверла		Глубина сверления (L/D)	Обозначение	Сплав	Размеры (мм)						
AWG*	дюйм	DC (мм)	дюйм				TF15	LU	LCF	LH	OAL	LF	PL
—	1/4	6.38	.251	5	MCT0638X05S070	<input type="checkbox"/>	32.8	47	47	96	95.1	0.9	7
—	3/8	9.55	.375	5	MCT0955X05S100	<input type="checkbox"/>	49.1	71	71	122	120.7	1.3	10

*AWG : Американская мера измерения диаметра

РЕКОМЕНДУЕМЫЕ РЕЖИМЫ РЕЗАНИЯ

Обрабатываемый материал		X				S				
		CFRP				Титановые сплавы Ti-6Al-4V и т. д.				
Диам. сверла DC (мм)	Диам. сверла DC (дюйм)	Скорость резания (м/мин)	Частота вращения (мин ⁻¹)	Подача (Мин.—Макс.) (мм/об)	Подача (мм/мин)	Скорость резания (м/мин)	Частота вращения (мин ⁻¹)	Подача (Мин.—Макс.) (мм/об)	Подача (мм/мин)	Ступенчатая подача (мм)
6.38	.251	100	5000	0.15 (0.10—0.20)	750	15	750	0.02 (0.01—0.03)	15	1
9.55	.375	100	3400	0.15 (0.10—0.20)	680	15	500	0.02 (0.01—0.03)	10	1

Примечание 1) Эти условия применяются при использовании внутренней подачи воздуха или тумана.

Примечание 2) Мы рекомендуем определить условия резания для каждого обрабатываемого материала в отдельности.

: Нет на складе, выпускается исключительно под заказ.

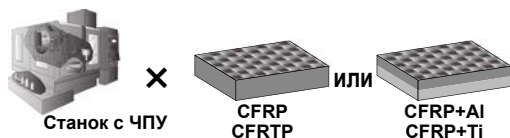

Внутреннее охлаждение

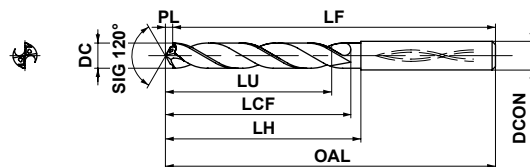

	$6 < DC \leq 10$
	$\begin{matrix} 0 \\ -0.022 \end{matrix}$
	$6 < DCON \leq 10$
	$\begin{matrix} 0 \\ -0.009 \end{matrix}$

Диам. отверстием		Диам. сверла		Глубина сверления (L/D)	Обозначение	Сплав		Размеры (мм)						
AWG*	дюйм	DC (мм)	дюйм			HT10	DD210	LU	LCF	LH	OAL	LF	PL	DCON
—	1/4	6.38	.251	5	MCW0638X05S070	<input type="checkbox"/>	<input type="checkbox"/>	33.7	52	52	92	90.2	1.8	7
—	3/8	9.55	.375	5	MCW0955X05S100	<input type="checkbox"/>	<input type="checkbox"/>	50.6	73	73	119	116.2	2.8	10

*AWG : Американская мера измерения диаметра

РЕКОМЕНДУЕМЫЕ РЕЖИМЫ РЕЗАНИЯ

Обрабатываемый материал		X				
		CFRP				
Диам. сверла DC (мм)	Диам. сверла DC (дюйм)	Скорость резания (м/мин)	Частота вращения (мин ⁻¹)	Подача (Мин.—Макс.) (мм/об)	Подача (мм/мин)	
6.38	.251	100	5000	0.15 (0.10—0.20)	750	
9.55	.375	100	3400	0.15 (0.10—0.20)	680	

Обрабатываемый материал		N					S				
		Алюминиевые сплавы (Si<5%) A6061, A7075 и т. д.					Титановые сплавы Ti-6Al-4V и т. д.				
Диам. сверла DC (мм)	Диам. сверла DC (дюйм)	Скорость резания (м/мин)	Частота вращения (мин ⁻¹)	Подача (Мин.—Макс.) (мм/об)	Подача (мм/мин)	Ступенчатая подача (мм)	Скорость резания (м/мин)	Частота вращения (мин ⁻¹)	Подача (Мин.—Макс.) (мм/об)	Подача (мм/мин)	Ступенчатая подача (мм)
6.38	.251	100	5000	0.15 (0.10—0.20)	750	3	15	750	0.02 (0.01—0.03)	15	1
9.55	.375	100	3400	0.15 (0.10—0.20)	500	3	15	500	0.02 (0.01—0.03)	10	1

Примечание 1) Эти условия применяются при использовании внутренней подачи воздуха или тумана.

Примечание 2) Мы рекомендуем определить условия резания для каждого обрабатываемого материала в отдельности.

ИНСТРУМЕНТ ДЛЯ СВЕРЛЕНИЯ (МОНОЛИТНЫЕ ТВЕРДОСПЛАВНЫЕ СВЕРЛА)

ТВЕРДЫЙ СПЛАВ

МССН



- P
- M
- K
- N
- S
- H
- CFRP

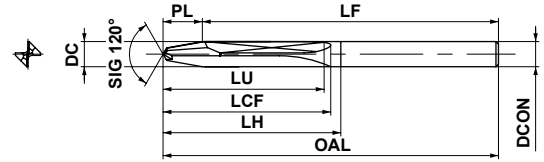
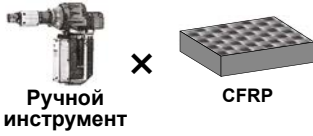

	$1 \leq DC \leq 3$	$3 < DC \leq 6$	$6 < DC \leq 10$
	0 -0.014	0 -0.018	0 -0.022
	$DCON=3$	$3 < DCON \leq 6$	$6 < DCON \leq 10$
	0 -0.006	0 -0.008	0 -0.009



Диам. отверстием		Диам. сверла		Глубина сверления (L/D)	Обозначение	Сплав DT2030	Размеры (мм)						
AWG*	дюйм	DC (мм)	дюйм				LU	LCF	LH	OAL	LF	PL	DCON
#40	—	2.5	.0985	15	МССН0250X15S030	★	42.1	48	50	100	95.4	4.6	3
#30	—	3.26	.1285	10	МССН0326X10S040	★	38.6	48	50	100	94.0	6.0	4
#20	—	4.1	.1615	8	МССН0410X08S050	★	40.3	48	50	100	92.5	7.5	5
#11	—	4.86	.1915	5	МССН0486X05S050	★	33.2	48	50	100	91.1	8.9	5
—	1/4	6.38	.251	3	МССН0638X03S070	★	30.8	48	50	100	88.3	11.7	7
—	3/8	9.55	.375	2	МССН0955X02S100	★	36.6	48	50	100	82.5	17.5	10

*AWG : Американская мера измерения диаметра

Примечание 1) пожалуйста, проверьте руководство по условиям резания для вашего ручного инструмента.

★ : Со склада в Японии.

P M K **N** S H CFRP+AI



Ручной
инструмент

×

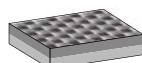

CFRP+AI

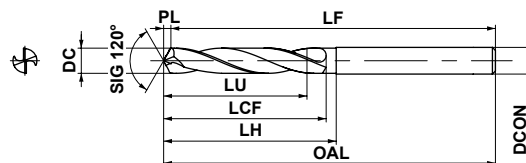

$1 \leq DC \leq 3$	$3 < DC \leq 6$	$6 < DC \leq 10$
0 -0.014	0 -0.018	0 -0.022
$DCON=3$	$3 < DCON \leq 6$	$6 < DCON \leq 10$
0 -0.006	0 -0.008	0 -0.009



Диам. отверстием		Диам. сверла		Глубина сверления (L/D)	Обозначение	Сплав DT2030	Размеры (мм)						
AWG*	дюйм	DC (мм)	дюйм				LU	LCF	LH	OAL	LF	PL	DCON
#40	—	2.5	.0985	15	МСАН0250X15S030	★	38.2	50	50	100	99.3	0.7	3
#30	—	3.26	.1285	15	МСАН0326X15S040	★	49.8	50	50	100	99.1	0.9	4
#20	—	4.1	.1615	10	МСАН0410X10S050	★	42.2	50	50	100	98.8	1.2	5
#11	—	4.86	.1915	8	МСАН0486X08S050	★	40.3	50	50	100	98.6	1.4	5
—	1/4	6.38	.251	5	МСАН0638X05S070	★	33.7	50	50	100	98.2	1.8	7
—	3/8	9.55	.375	3	МСАН0955X03S100	★	31.5	50	50	100	97.2	2.8	10

*AWG : Американская мера измерения диаметра

Примечание 1) пожалуйста, проверьте руководство по условиям резания для вашего ручного инструмента.

М

ИНСТРУМЕНТ ДЛЯ
СВЕРЛЕНИЯ

ЗАПАСНЫЕ ЧАСТИ

ОБОЗНАЧЕНИЕ.....	N002
ЗАПАСНЫЕ ЧАСТИ	
КРЕПЁЖНЫЙ ВИНТ	N003
УСТАНОВОЧНЫЙ БОЛТ.....	N009
РЕГУЛИРОВОЧНЫЙ ВИНТ / ГАЙКА	N010
ОПОРНАЯ ПЛАСТИНА	N011
ШТИФТ ОПОРНОЙ ПЛАСТИНЫ И ЗАЖИМНОЙ РЫЧАГ	N014
ЗАПИРАЮЩИЙ ШТИФТ	N015
ПРИХВАТ	N015
ЭЛЕМЕНТ СТРУЖКОЛОМА	N017
ПРОТИВОЗАДИРНАЯ СМАЗКА.....	N018



ОБОЗНАЧЕНИЕ

ЗАПАСНЫЕ ЧАСТИ

ОБОЗНАЧЕНИЕ ПРИЖИМНОГО ВИНТА (Метрическая винтовая правая крупная резьба)

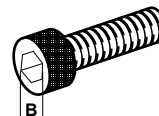

H SC 060 05

Длина

Пример	
Обозначение	L
05	5
10	10
20	20
30	30

Диаметр резьбы

Пример	
Обозначение	d
050	M5
060	M6

Размеры шестигранного отверстия

Диаметр	Шаг	В Размеры			
		HVH	HFC	HSC	HS \odot
M2	0.4	—	—	1.5	0.9
M2.5	0.45	—	—	2	1.3
M3	0.5	2	2	2.5	1.5
M4	0.7	2.5	2.5	3	2
M5	0.8	3	3	4	2.5
M6	1	4	4	5	3
M8	1.25	5	5	6	4
M10	1.5	6	6	8	5

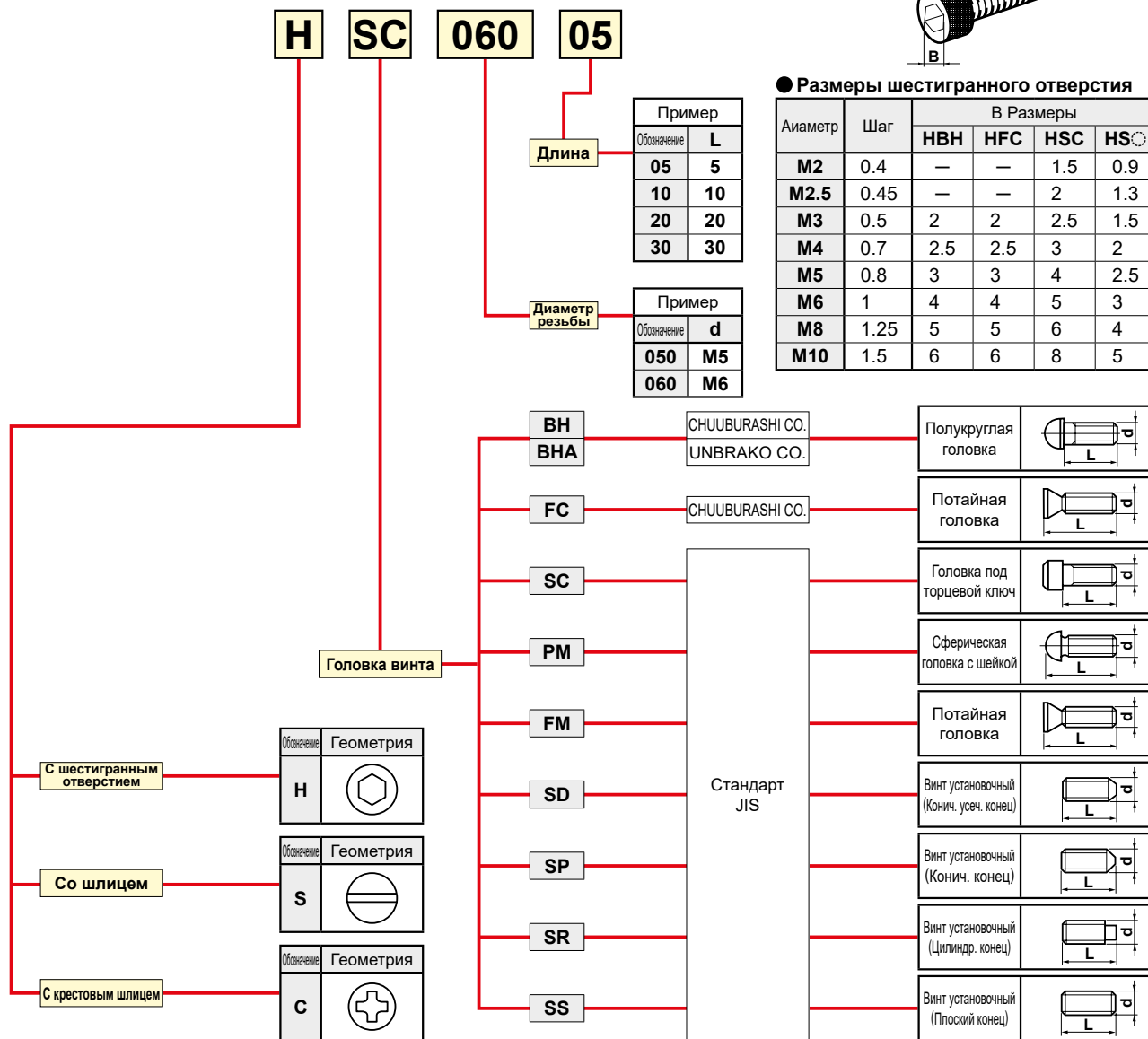

ОБОЗНАЧЕНИЕ КЛЮЧА

HKY 15 R

Обозначение	Ключ
HKY	Шестигранный ключ
TKY	Звездообразный ключ
RKY	R-образный ключ
TIP	Torx plus ключ

Шестигранный ключ	
Обозначение	В
15	1.5
20	2
25	2.5
30	3
35	3.5
40	4
50	5
60	6

Звездообразный ключ		
Обозначение	В	Размер
06	1.7	T6
08	2.3	T8
10	2.7	T10
15	3.3	T15
20	3.8	T20
25	4.4	T25
27	5.0	T27
30	5.5	T30

Torx plus ключ		
Обозначение	В	Размер
06	1.8	6IP
07	2.1	7IP
08	2.4	8IP
10	2.8	10IP
15	3.4	15IP

R	Стандартный L-образный ключ	
L	Длинный L-образный ключ	
T	T-образный ключ	
F FS	Флажковый ключ	
W	Флажковый ключ	
D DS	Отвертка	
S	Ключ	

IMX 10 - WR

Обозначение	Ключ
IMX	Ключ для серии IMX

Шестигранный ключ	
Обозначение	В
10	8
12	10
16	13
20	16
25	20

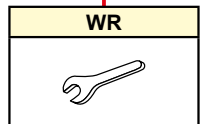

ЗАПАСНЫЕ ЧАСТИ

КРЕПЁЖНЫЙ ВИНТ

Геометрия	Обозначение	Размеры (мм)					Угол B1	MPCDS	TQ (Н·м)	Державка
		MPCA	MPCB	MPCC	MPCD	MPCE				
	AJS3010T10	5	M3×0.5	10	1.5	2.8	120°	T10	2.5	Профильное Державка (⊕C032) AJX (⊕K180) AJX (⊕K180)
	AJS4012T15	7	M4×0.7	12	2.2	3.4	120°	T15	3.5	
	AJS5014T25	8	M5×0.8	14	2.7	4.5	120°	T25	7.5	
	BRS103	5	M3×0.5	9.9	2.9	3.4	120°	T15	3.5	
	BRS105	8	M5×0.8	13.8	3.8	4.5	120°	T25	7.5	
	CAS51T	7.9	M5×0.8	19	5	4.5	10°	T25	8.5	
	CS200T	3.2	M2×0.4	5	1.6	1.8	90°	T6	0.6	F Тип расточного инструмента (⊕E027) Серия инструментов для фрезерования (⊕K001) BRP (⊕K190) DCCC (⊕K200) ММТI Тип расточного инструмента (⊕G026) BRP (⊕K190) DCCC (⊕K200) Державка AL типа (⊕C034) АНХ640S (⊕K041) PMR (⊕K236)
	CS250T	3.7	M2.5×0.45	6	1.8	2.4	90°	T8	1.0	
	* CS250560T	3.9	M2.5×0.45	5.2	2.5	2.4	60°	T8	1.0	
	CS300590T	4.1	M3×0.5	5.5	2.1	2.4	90°	T8	1.0	
	CS300790TS	4.7	M3×0.5	7	2.3	2.8	90°	T10	2.0	
	CS300890T	4.1	M3×0.5	8	2.1	2.4	90°	T8	1.0	
	CS350690T	4.8	M3.5×0.6	6.5	2.4	2.8	90°	T10	2.5	
	* CS350760T	5.5	M3.5×0.6	7	4.0	3.4	60°	T15	3.5	
	CS350790T	4.8	M3.5×0.6	7	2.4	2.8	90°	T10	3.5	
	* CS350860T	5.5	M3.5×0.6	8.4	4.0	3.4	60°	T15	3.5	
	CS350990T	4.8	M3.5×0.6	9	2.4	2.8	90°	T10	2.5	
	CS400990T	6.0	M4×0.7	9	2.8	3.4	90°	T15	3.5	
	CS401160T	5.7	M4×0.7	11	4.5	3.4	60°	T15	3.5	
	CS401990T	6.0	M4×0.7	19	3.0	3.9	90°	T20	3.5	
	CS451190T	6.3	M4.5×0.75	11	2.9	3.9	90°	T20	5.0	
* CS501160T	7.0	M5×0.8	11	3.6	3.9	60°	T20	5.0		
CS501290T	7.0	M5×0.8	11	3.5	4.5	90°	T25	7.5		
* CS5015060T	7.2	M5×0.8	15	2.4	3.9	60°	T20	5.0		
CS502190T	8.5	M5×0.8	21	4.0	5.1	90°	T27	7.5		
CS6016060T	8.5	M6×1.0	16	4.5	4.5	60°	T25	7.5		
	CSF401260T	7.2	M4×0.5	12	5.2	3.9	60°	T20	5.0	
	DC0520T	8.5	M5×0.8	22.5	2.5	3.4	—	T15	3.5	Державка С ДВОЙНЫМ ПРИЖИМОМ (⊕C008) БОРШТАНГА С ДВОЙНЫМ ЗАХВАТОМ (⊕E015) НСК Державка (⊕H001)
	DC0621T	10.5	M6×1.0	25	4	3.9	—	T20	5.0	
	DKS4	5.6	M4×0.7	18	3.5	3	—	—	3.3	
	DKS5	7.6	M5×0.8	19	4.5	4	—	—	7.0	

N

ЗАПАСНЫЕ ЧАСТИ

ЗАПАСНЫЕ ЧАСТИ

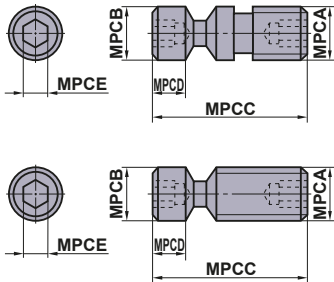
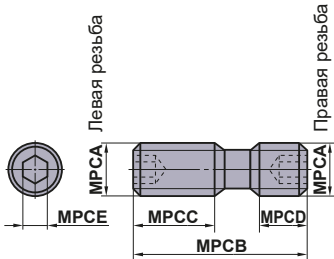
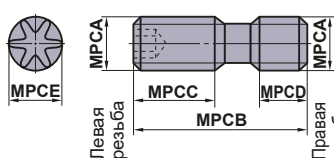
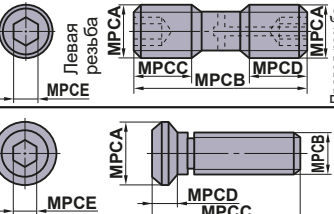

КРЕПЁЖНЫЙ ВИНТ

Геометрия	Обозначение	Размеры (мм)					Угол B1	MPCOS	TQ (N·M)	Державка
		MPCA	MPCB	MPCC	MPCD	MPCE				
	EGS06019	9	M6×1	22.5	3.5	3	—	—	3.3	
	EGS08024	11	M8×1.25	28.5	4.5	4	—	—	7.0	
	FC400890T	5.6	M4×0.7	7.5	1.3	2.8	90°	T10	2.5	Державка AL типа (☉C035) AL Тип расточного инструмента (☉E041)
	GY05016S	8.7	M5×0.8	16	3.5	3.9	90°	T20	5.0	GY Серия (☉F004)
	GY06013M	12	M6×1	18	5	5.6	—	T30	6.0	GY Серия (☉F004)
	HFF06015	10	M6×1	15	6	5	80°	—	8.2	
	HS4L	5.4	M4×0.7	14	2.3	2.5	80°	—	3.8	
	HS5S	6.8	M5×0.8	9	2.8	3	80°	—	3.3	
	HS5L	6.8	M5×0.8	15	2.8	3	80°	—	6.6	
	HSP05008C	M5×0.8	8	—	—	2.5	—	—	2.5	Державка MP типа (☉C019)
	HY-A1	4.4	M3×0.5	7	2.1	2	82°	—	1.5	
	HY-V1	5.5	M3×0.5	7	2.5	2	82°	—	1.5	
	HY2	5.5	M3×0.5	10	2.5	2	82°	—	1.5	
	HY3	7	M3.5×0.6	12	2.9	2	82°	—	1.5	
	HY4	9.3	M5×0.8	16	3.6	3	82°	—	3.3	
	JSS6	6.9	M6×0.75	4.5	1.5	0.8	—	—	—	
	JSS7	8	M7×0.75	4.4	1.5	1	—	—	—	
	KS1	7	M4×0.7	14	5	—	—	—	—	
	KS2	10	M6×1	18	7	—	—	—	—	
	KS2S	10	M6×1	18	7	—	—	—	—	
	KS12	10	M6×1	26	4	4	—	—	7.0	
	LLR1	M5×0.8	—	3.5	—	2.5	—	—	—	
	LLR2	M6×1	—	5	—	3	—	—	—	

Геометрия	Обозначение	Размеры (мм)					Угол B1	MPCOS	TQ (Н·м)	Державка
		MPCA	MPCB	MPCC	MPCD	MPCЕ				
 <p>LLCS103, LLCS105 LLCS112, LLCS125 LLCS205</p> <p>Обозначенные "*" изделия не имеют на конце отверстие, обозначенное буквой MPCB.</p> <p>Обозначенные "☆" изделия не имеют на конце отверстие, обозначенное буквой MPCA.</p>	☆ LLCS103	M3×0.5	4	11	4.6	2	—	—	1.5	Р Тип расточного инструмента (⊕E037) HSK Державка (⊕H001)
	* LLCS105	M5×0.8	M5×0.8	10	1.5	2	—	—	1.5	
	LLCS106	M6×1	6	16.5	3.5	2.5	—	—	2.2	
	* LLCS106S	M6×1	6	13.4	0.7	2.5	—	—	2.2	
	LLCS108	M8×1.25	8	21	6.5	3	—	—	3.3	
	* LLCS108S	M8×1.25	8	16.5	2	3	—	—	3.3	
	LLCS110	M10×1.5	10	29	8	4	—	—	7.0	
	LLCS112	M12×1	11.9	36.2	9	5	—	—	8.0	
	LLCS125	M5×0.8	M5×0.8	12	2	2	—	—	1.5	
	LLCS205	M5×0.8	M5×0.8	16	4	2	—	—	1.5	
	LLCS206	M6×1	6	26	13	2.5	—	—	2.2	
	LLCS208	M8×1.25	8	24	6.5	3	—	—	3.3	
	LLCS306	M6×1	6	21	4	2.5	—	—	2.2	
	LLCS308	M8×1.25	8	42	27.5	3	—	—	3.3	
	LLCS310	M10×1	10	29	8	4	—	—	7.0	
	LLCS410	M10×1	10	30	6.6	4	—	—	7.0	
	LLCS508	M8×1	8	24	6.5	3	—	—	3.3	
	* LLCS508S	M8×1	8	20.5	3	3	—	—	3.3	
 <p>Левая резьба Правая резьба</p> <p>* Без шестигранного отверстия со стороны с правой резьбой</p>	LS1	M6×1	22	8	8	3	—	—	5.0	Серия инструментов для фрезерования (⊕K001)
	LS2	M8×1	29	13	10	4	—	—	8.2	
	LS3	M8×1	32	13	13	4	—	—	8.2	
	* LS4	M6×1	15	8	4	3	—	—	5.0	
	* LS5	M6×1	18	8	5	3	—	—	5.0	
	* LS6	M8×1	24	13	5	4	—	—	8.2	
	* LS7	M8×1	27	13	8	4	—	—	8.2	
	* LS8	M6×0.75	18	7	7	3	—	—	5.0	
	* LS9	M6×0.75	22	8	8	3	—	—	5.0	
	* LS10	M7×0.75	16	6	6	4	—	—	8.2	
	* LS11	M8×1	16	6	6	4	—	—	7.8	
	* LS12	M8×1	24	7	7	4	—	—	7.8	
	* LS13	M8×1	34	12	12	4	—	—	7.8	
	* LS14	M7×0.75	24	10	10	4	—	—	7.8	
	* LS16	M7×0.75	23	11	8	4	—	—	7.8	
* LS18	M7×0.75	14	6	4	4	—	—	7.8		
* LS20	M10×1.5	26	9	9	5	—	—	9.0		
* LS21	M10×1.5	32	12	12	5	—	—	9.0		
LS24	M8×1.25	24	8.5	8.5	4	—	—	7.8	Державка с ДВОЙНЫМ ПРИЖИМОМ (⊕K009)	
LS25	M8×1	28.5	12.0	10.5	4	—	—	8.2		
 <p>Левая резьба Правая резьба</p>	LS10T	M7×0.75	14	6	5	4.5	—	T25	8.0	АНХ640W (⊕K048)
	LS14T	M7×0.75	24	10	10	4.5	—	T25	8.0	
	LS15T	M7×0.75	18	7	7	4.5	—	T25	8.0	
	LS19T	M6×0.75	11	4	4	3.4	—	T15	5.0	
	LS10TS	M7×0.75	13	6	4	4.5	—	T25	8.5	
	LS0622T	M6×0.75	22	8	8	3.4	—	T15	6.0	
 <p>Левая резьба Правая резьба</p>	LS24H	M8×1.25	24	8.5	8.5	4	—	—	8.2	
	MHT1	11	M8×1	18.5	3.5	4	—	—	8.7	

ЗАПАСНЫЕ ЧАСТИ

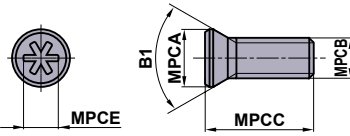
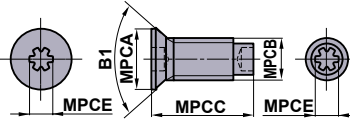
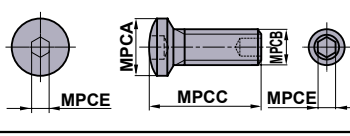
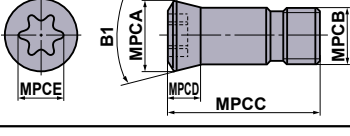
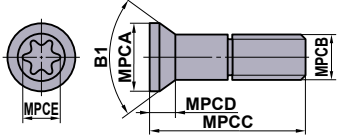
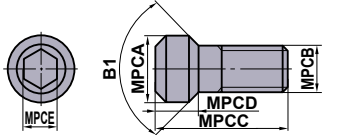
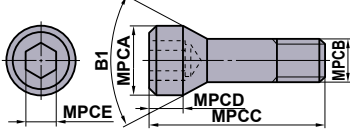
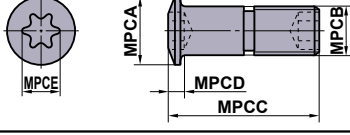
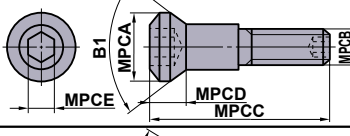
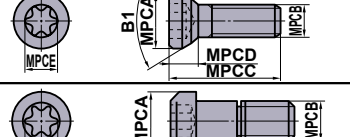
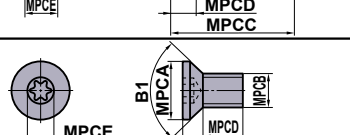
КРЕПЁЖНЫЙ ВИНТ

Геометрия	Обозначение	Размеры (мм)					Угол B1	MPCDS	TQ (N·m)	Державка
		MPCA	MPCB	MPCC	MPCD	MPCE				
	NS251	3.6	M2.5×0.45	7	—	2.2	60°	—	0.7	БТВН (⌀D016) CSVH (⌀D027) СТАН-S (⌀D020)
	NS401	5.8	M4×0.7	6	—	3.6	60°	—	3.5	
	NS402W	5.85	M4×0.7	10	—	2.2	60°	—	0.7	СТАН (⌀D020) СТВН (⌀D022)
	NS403W	5.85	M4×0.7	12	—	2.2	60°	—	0.7	
	NS404W	5.8	M4×0.7	10	—	2.2	90°	—	0.7	
	NS501W	8	M5×0.8	16	—	2.5	120°	—	2.2	МЕЛКОРАЗМЕРНЫЙ ИНСТРУМЕНТ (⌀D001)
	NS502W	8	M5×0.8	20	—	2.5	120°	—	2.2	
	RN-S6	9.5	M6×0.75	20.3	4.6	3.9	61°	T20	5.0	
	RN-S7	11	M7×0.75	24.7	5.2	4.5	61°	T25	7.5	
	RS3008T	4.3	M3×0.35	8.6	2	2.4	61°	T8	1.5	SRF (⌀K212) SUF (⌀K216)
	RS3510T	5	M3.5×0.35	10	2.3	2.8	61°	T10	2.5	
	RS4015T	6	M4×0.5	14	2.7	3.4	61°	T15	3.3	
	RS5020T	8.1	M5×0.5	16.4	3.6	3.9	61°	T20	5.0	
	RS6025T	9.5	M6×0.75	21.5	4.2	4.5	61°	T25	7.5	
	RS8030T	12	M8×0.75	25	5	5.6	61°	T30	10.0	
	S1	3.5	M2×0.4	5.5	2.2	1.5	92°	—	0.6	
	S3	4.5	M3×0.5	7.7	2.4	2	92°	—	1.5	
	S4	5.3	M4×0.7	8	1.8	2.5	62°	—	2.2	
	S5	6.8	M5×0.8	9	2.4	3	62°	—	3.3	
	SD32	12	M8×1.25	28	7.2	6	50°	—	9.5	
	SD40	12	M8×1.25	36	7.2	6	50°	—	9.5	
	SD50	16	M10×1.5	46	8.2	8	50°	—	1.0	
	SD63	16	M10×1.5	61	8.2	8	50°	—	1.0	
	SETS51	6.8	M5×0.8	14.8	1.5	3.4	—	T15	3.5	Державка MMTE типа (⌀G019) MMTI Тип расточного инструмента (⌀G026) HSK Державка (⌀H001)
	SETS61	8	M6×1	20	1.8	3.9	—	T20	5.0	
	SLCS105	10	M5×0.8	25	6.3	4	90°	—	7.0	Державка WP типа (⌀C017)
	SLCS106	12	M6×1	32	6.2	4	90°	—	7.0	
	SPS1	8.5	M5×0.8	16	4	4.5	70°	T25	5.0	
	SRS5	6.7	M5×0.8	16	3.5	3.9	—	T20	5.0	
	STS1	6.8	M3×0.5	7	2.2	2.8	90°	T10	2.5	

N

ЗАПАСНЫЕ ЧАСТИ

Геометрия	Обозначение	Размеры (мм)					Угол	MPCDS	TQ (N·м)	Державка
		MPCA	MPCB	MPCC	MPCD	MPCE				
	* TS16	2.5	M1.6×0.35	3.2	1.6	1.8	60°	T6	0.6	MICRO-DEX (☉E018)
	TS2	2.7	M2×0.4	4.6	1.4	1.8	60°	T6	0.6	
	* TS2A	2.7	M2×0.4	4.5	1.2	1.8	60°	T6	0.6	AQX (☉K172)
	TS2C	2.7	M2×0.4	3.8	1.4	1.8	60°	T6	0.6	
	☆ TS2D	3.8	M2×0.4	5.3	1.9	1.8	82°	T6	0.6	DIMPLE BAR (☉E007)
	TS21	2.7	M2×0.4	3.4	1.4	1.8	60°	T6	0.6	F Тип расточного инструмента (☉E029)
	* TS22	3.0	M2.2×0.45	5	1.2	1.8	60°	T6	0.6	S Тип расточного инструмента (☉E030)
	* TS25	3.3	M2.5×0.45	5.5	1.7	2.4	60°	T8	1.0	AQX (☉K172) AJX (☉K180)
	☆ TS25D	4.4	M2.5×0.45	6.2	2.2	2.4	82°	T8	1.0	ММТI Тип расточного инструмента (☉G026)
	* TS25H	3.6	M2.5×0.45	5.5	2	2.4	60°	T8	1.0	SRM2 (☉K220)
	TS202	2.7	M2×0.4	5.5	1.8	1.8	60°	T6	0.6	
	TS253	3.3	M2.5×0.45	4.5	1.7	2.4	60°	T8	1.0	Серия инструментов для фрезерования (☉K001)
	TS254	3.3	M2.5×0.45	7	1.7	2.4	60°	T8	1.0	МЕЛКОРАЗМЕРНЫЙ ИНСТРУМЕНТ (☉D001) PMF (☉K234)
	* TS255	3.5	M2.5×0.45	7.5	1.6	2.4	60°	T8	1.0	Профильное Державка (☉C032)
	TS3	3.9	M3×0.5	6	2	2.4	60°	T8	1.0	TSMP (☉K232)
	TS304	3.9	M3×0.5	10.5	2.0	2.4	60°	T8	1.5	
	TS3D	5.0	M3×0.5	6	2.3	2.8	82°	T10	2.5	DIMPLE BAR (☉E007)
	* TS3SB	4.4	M3×0.5	8	2	2.4	80°	T8	1.5	AXD4000 (☉K155)
	TS3SBS	4.4	M3×0.5	6.5	2	2.4	80°	T8	1.5	AXD4000 (☉K155)
	☆ TS31D	4.8	M3×0.5	7.2	2.2	2.8	82°	T10	2.5	DIMPLE BAR (☉E007)
	* TS32	3.9	M3×0.5	7.5	2	2.4	60°	T8	2.0	SRM2 (☉K220)
	* TS33	3.9	M3×0.5	6.7	2	2.4	60°	T8	1.5	AQX (☉K172) AJX (☉K180)
	TS35	4.8	M3.5×0.6	6.5	2.4	2.8	60°	T10	2.5	
	* TS35D	5.3	M3.5×0.6	12	2.8	3.4	60°	T15	3.5	HSK Державка (☉H001)
	★ TS35R	5.7	M3.5×0.6	10	2.1	3.4	—	T15	3.5	AHX440S (☉K034) AHX475S (☉K038)
	TS351	4.8	M3.5×0.6	7.2	2.4	2.8	60°	T10	2.5	AJX (☉K180) SRM2 (☉K220)
	TS352	4.8	M3.5×0.6	10	3	2.8	60°	T10	2.5	VFX5 (☉K192)
	* TS4S	5.4	M4×0.7	7	2.4	3.4	80°	T15	3.5	
	* TS4SL	5.4	M4×0.7	8	2.4	3.4	80°	T15	4.0	
	* TS4SB	5.8	M4×0.7	9	2.7	3.4	80°	T15	3.5	AXD7000 (☉K166)
	* TS4SBL	5.8	M4×0.7	10.5	2.7	3.4	80°	T15	3.5	GY Серия (☉F004) AXD7000 (☉K166)
	TS4	5.4	M4×0.7	8	2.6	3.4	60°	T15	3.5	CE/CF/CGSP (☉K230) TSMP (☉K232)
	TS4D	5.6	M4×0.7	7.7	2.5	3.4	82°	T15	3.5	DIMPLE BAR (☉E007)
	TS42	5.4	M4×0.7	6	2.6	3.4	60°	T15	3.5	
	TS43	5.4	M4×0.7	10	2.6	3.4	60°	T15	3.5	AJX (☉K180) BRP (☉K190) SRM2 (☉K220)
	TS44	5.4	M4×0.7	12	2.6	3.4	60°	T15	3.5	
	TS406	5.4	M4×0.7	15.5	2.6	3.4	60°	T15	3.5	
	TS407	5.4	M4×0.7	9	2.6	3.4	60°	T15	3.5	AQX (☉K172) AJX (☉K180)
	TS450	5.9	M4.5×0.75	13	3.6	3.9	60°	T20	5.0	VFX6 (☉K196)
	TS5S	6.8	M5×0.8	9	2.9	4.5	80°	T25	7.5	
	* TS5SL	6.8	M5×0.8	12	2.9	4.5	80°	T25	7.5	
	TS5	6.8	M5×0.8	9	3.2	4.5	60°	T25	7.5	SP Державка (☉C024) CE/CF/CGSP (☉K230) TSMP (☉K232)
	TS5L	6.8	M5×0.8	15	2.9	4.5	80°	T25	7.5	
	★ TS5R	6.9	M5×0.8	12	3.5	3.9	—	T20	5.0	WWX400 (☉K056) WJX (☉K072)
	TS52	6.8	M5×0.8	8	3.2	4.5	60°	T25	7.5	CE/CF/CGSP (☉K230)
	TS53	6.8	M5×0.8	16	3.2	4.5	60°	T25	7.5	
	TS54	6.8	M5×0.8	12	3.2	4.5	60°	T25	7.5	AJX (☉K180)
	TS55	6.8	M5×0.8	10.5	3.2	4.5	60°	T25	7.5	GY Серия (☉F004) AQX (☉K172) SPX (☉K203) SRM2 (☉K220)
	* TS6S	8.5	M6×1.0	13	4.4	5.6	60°	T30	10.0	AQX (☉K172) SRM2 (☉K220)
	* TS6	8.5	M6×1.0	16	4.4	5.6	60°	T30	10.0	SRM2 (☉K220)

N

ЗАПАСНЫЕ ЧАСТИ

ЗАПАСНЫЕ ЧАСТИ

КРЕПЁЖНЫЙ ВИНТ

ЗАПАСНЫЕ ЧАСТИ

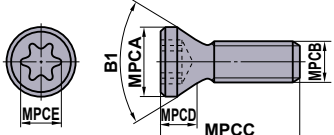
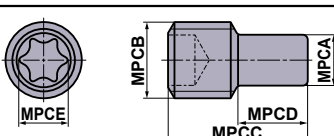
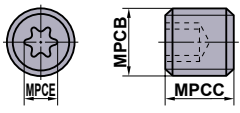
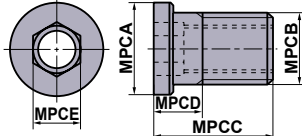
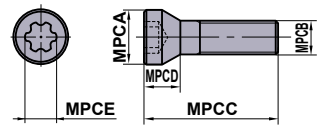
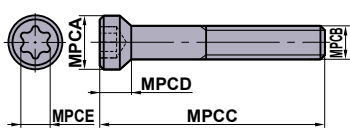
Геометрия	Обозначение	Размеры (мм)					Угол B1	MPCDS	TQ (N·m)	Державка
		MPCA	MPCB	MPCD	MPCD	MPCD				
	TPS20	2.7	M2×0.4	3.5	1.3	1.8	60°	6IP	0.5	
	TPS20-1	2.65	M2×0.4	4.7	2.4	1.8	60°	6IP	0.6	MVX (⊕M160)
	TPS22	3.0	M2.2×0.45	4.7	1.6	2.1	60°	7IP	0.5	
	TPS22S	3.0	M2.2×0.45	4.2	1.6	2.1	60°	7IP	0.5	
	TPS25	3.3	M2.5×0.45	5.5	1.7	2.1	60°	7IP	1.0	APX3000 (⊕K133) MVX (⊕M160)
	TPS25-1	3.3	M2.5×0.45	6.5	1.7	2.1	60°	7IP	1.0	APX3000 (⊕K133)
	TPS27F1	3.7	M2.7×0.35	6.5	1.8	2.1	60°	7IP	1.0	VPX200 (⊕K086)
	TPS27F2	3.7	M2.7×0.35	8.0	1.8	2.1	60°	7IP	1.0	VPX300 (⊕K100)
	TPS3	3.9	M3×0.5	6.7	1.4	2.82	60°	10IP	1.0	MVX (⊕M160)
	* TPS3R	4.6	M3×0.5	8.5	1.4	2.82	—	10IP	2.0	WJX09 (⊕K072)
	TPS3SB	4.4	M3×0.5	8	2.0	2.82	80°	10IP	3.0	AXD4000A (⊕K162)
	TPS35	5.3	M3.5×0.6	11.5	2.8	3.4	60°	15IP	3.5	ASX445 (⊕K026) ASX400 (⊕K068) PMR (⊕K236)
	TPS351	4.8	M3.5×0.6	7.2	1.4	2.82	60°	10IP	2.5	MVX (⊕M160)
	TPS351B	5.1	M3.5×0.6	7.2	1.4	2.82	60°	10IP	2.5	ARP (⊕K238)
	TPS4	5.3	M4×0.7	8	2.6	3.4	60°	15IP	3.5	APX4000 (⊕K140) ARP (⊕K238) MVX (⊕M160)
TPS40F1	5.3	M4×0.5	10.5	2.8	3.4	60°	15IP	3.0	VPX300 (⊕K100)	
TPS43	5.3	M4×0.7	10	2.6	3.4	60°	15IP	4.0	APX4000 (⊕K140) MVX (⊕M160)	
* TPS4R	6.4	M4×0.7	10.6	2.9	3.4	—	15IP	3.5	WSX445 (⊕K016)	
TPS54	6.8	M5×0.8	12	3.2	4.5	60°	25IP	7.5	MVX (⊕M160)	
	TSR05008S	3.5	M5×0.8	8	—	2.8	—	T10	—	
	TSR06011S	4	M6×1.0	11	—	3.9	—	T20	—	
	TSS04005	—	M4×0.7	5	—	2.4	—	T8	—	PMF (⊕K234)
	TSS04505S	—	M4.5×0.7	5	—	3.5	—	T10	3.5	FMAX (⊕K051)
	TSS05006	—	M5×0.8	6	—	2.8	—	T10	—	
	TSS06010	—	M6×1	10	—	3.9	—	T20	—	
	WCS503507H	6.3	M5×0.5	7	3.3	3.5	—	—	5.0	ASX445 (⊕K026) ASX400 (⊕K068) PMR (⊕K236)
	WCS604010H	7.8	M6×0.75	10	4.1	4.0	—	—	7.0	PMR (⊕K236)
	WS203107TPS	3.1	M2×0.25	7.3	1.7	1.8	60°	6IP	1.0	STAW (⊕M141)
	WS203108TPS	3.1	M2×0.25	8.3	1.9	1.8	60°	6IP	1.0	
	WS253909TPS	3.9	M2.5×0.35	9.5	2.4	2.4	60°	8IP	2.0	
	WS304912TPS	4.9	M3×0.35	12	3.25	2.82	60°	10IP	2.5	
	WS254012T	4	M2.5×0.45	11.5	2.2	2.4	80°	T8	2.0	TAW (⊕M150)
	WS254013T	4	M2.5×0.45	12.5	2.2	2.4	80°	T8	2.0	
	WS254014T	4	M2.5×0.45	13.5	2.2	2.4	80°	T8	2.0	
	WS254015T	4	M2.5×0.45	14.5	2.2	2.4	80°	T8	2.0	
	WS254016T	4	M2.5×0.45	15.5	2.2	2.4	80°	T8	2.0	
	WS304517T	4.5	M3×0.5	16.5	3.4	2.8	60°	T10	3.5	
	WS304518T	4.5	M3×0.5	17.5	3.4	2.8	60°	T10	3.5	
	WS355520T	5.5	M3.5×0.6	19.5	3.9	3.4	60°	T15	5.5	
	WS355521T	5.5	M3.5×0.6	20.5	3.9	3.4	60°	T15	5.5	
	WS406023T	6	M4×0.7	22.0	4.4	4.5	60°	T25	8.5	
	WS406024T	6	M4×0.7	23.0	4.4	4.5	60°	T25	8.5	
	WS508026T	8	M5×0.8	25.0	5.2	5.1	60°	T27	12.0	
	WS508027T	8	M5×0.8	26.0	5.2	5.1	60°	T27	12.0	

УСТАНОВОЧНЫЙ БОЛТ

Геометрия	Обозначение	Размеры (мм)					Угол B1	MPCDS	TQ (N·м)	Державка
		MPCA	MPCB	MPCC	MPCD	MPCE				
	BOES101	15	M10×1.5	45	10	8	60°	—	10.0	
	* HSC08025H	13	M8×1.25	33	8	5	—	—	24	VPX200/300 (⊙K086,K100) ARP (⊙K238)
	HSC05030	8.5	M5×0.8	35	5	4	—	—	10	APX3000/4000 (⊙K133,K140)
	* HSC08030H	13	M8×1.25	38	8	5	—	—	24	WSX445 (⊙K016)
	HSC08045	13	M8×1.25	53	8	5	—	—	24	VPX200/300 (⊙K086,K100)
	HSC08040	13	M8×1.25	48	8	5	—	—	24	WSX445 (⊙K016)
	HSC08050	13	M8×1.25	58	8	5	—	—	24	VPX200/300 (⊙K086,K100)
	* HSC10030H	16	M10×1.5	40	10	6	—	—	40	APX3000/4000 (⊙K133,K140) AJX (⊙K180) WSX445 (⊙K016)
	HSC10035	16	M10×1.5	45	10	6	—	—	44	VFX5 (⊙K192) VFX6 (⊙K196)
	HSC10050	16	M10×1.5	60	10	8	—	—	44	APX3000/4000 (⊙K133,K140) VPX200/300 (⊙K086,K100)
	HSC10055	16	M10×1.5	65	10	8	—	—	44	VFX5 (⊙K192)
	HSC10060	16	M10×1.5	70	10	8	—	—	44	VPX200/300 (⊙K086,K100)
	HSC10070	16	M10×1.5	80	10	8	—	—	44	VPX200/300 (⊙K086,K100) ASPX (⊙K028)
	HSC12035	18	M12×1.75	47	12	10	—	—	80	WSX445 (⊙K016)
	* HSC12035H	18	M12×1.75	47	12	10	—	—	80	APX3000/4000 (⊙K133,K140) AJX (⊙K180)
	HSC12040	18	M12×1.75	52	12	10	—	—	80	
	HSC12045	18	M12×1.75	57	12	10	—	—	80	WSX445 (⊙K016)
	HSC12060	18	M12×1.75	72	12	10	—	—	80	VPX200/300 (⊙K086,K100)
	HSC12070	18	M12×1.75	82	12	10	—	—	80	APX3000/4000 (⊙K133,K140) AJX (⊙K180) WSX445 (⊙K016)
	HSC16040	24	M16×2	56	16	14	—	—	150	WSX445 (⊙K016)
	* HSC16040H	24	M16×2	56	16	14	—	—	150	APX3000/4000 (⊙K133,K140) AJX (⊙K180)
HSC16055	24	M16×2	71	16	14	—	—	150	VPX200/300 (⊙K086,K100)	
HSC16065	24	M16×2	81	16	14	—	—	150	VPX200/300 (⊙K086,K100)	
HSC16080	24	M16×2	96	16	14	—	—	150		
HSC20040	30	M20×2.5	60	20	17	—	—	320		
HSC20090	30	M20×2.5	110	20	17	—	—	320		
	HSCX12030H	24	M12×1.75	37	7	8	—	—	40	FMAX (⊙K051)
	HSCX16035H	30	M16×2	44	9	12	—	—	100	
	HSCX20035H	36	M20×2.5	46	11	14	—	—	180	
	HFF08033H	11	M8×1.25	33	5	5	90°	—	8.2	WJX09 (⊙K072)
	HFF08043H	11	M8×1.25	43	5	5	90°	—	8.2	AXD4000 (⊙K155)
	MBA16033H	40	M16×2	43	10	14	—	—	150	AHX640 (для ⌀100) (⊙K041) WSX445 (⊙K016)
	MBA20040H	50	M20×2.5	54	14	17	—	—	320	APX4000 (⊙K140) AHX475S (⊙K038) AHX640S (⊙K041) AXD4000 (⊙K155) AXD7000 (⊙K166) AJX (⊙K180)

* С отверстием для смазочноохлаждающей жидкости.

Геометрия	Обозначение	Размеры (мм)						TQ (N·м)	Державка
		MPCA	MPCB	MPCC	MPCD	MPCE	MPCF		
	HDS08030	M8×0.75	M8×1.25	30	13.5	11.5	4	8.2	BRP (⊙K190)
	HDS10031	M10×1.0	M10×1.5	31	14	12	5	9.0	PMF (⊙K234)

ЗАПАСНЫЕ ЧАСТИ

ЗАПАСНЫЕ ЧАСТИ

ВИНТ ГРУБОЙ РЕГУЛИРОВКИ

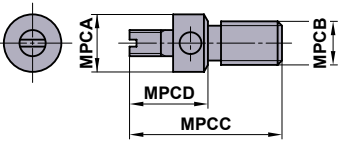
Геометрия	Обозначение	Размеры (мм)					Угол	MPCOS	TQ (N·M)	Державка
		MPCA	MPCB	MPCC	MPCD	MPCE	B1			
	KSS2	6.6	M5×0.8	17.5	9	—	—	—	FMAX (K051)	

Z

ЗАПАСНЫЕ ЧАСТИ

ГАЙКА МИКРО РЕГУЛИРОВКИ

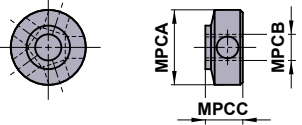
Геометрия	Обозначение	Размеры (мм)					Угол	MPCOS	TQ (N·M)	Державка
		MPCA	MPCB	MPCC	MPCD	MPCE	B1			
	KSN3	8.6	M3×0.35	4.3	—	—	—	—	FMAX (K051)	

ОПОРНАЯ ПЛАСТИНА

Геометрия	Обозначение	Размеры (мм)						Державка
		MPCA	MPCB	MPCC	MPCD	MPCE	MPCF	
	CS32	9.52	3.18	0.8	0.8	1.2	1.2	
	CS42	12.70	3.18	0.8	0.8	1.2	1.6	
	CS43	12.70	4.76	0.8	0.8	1.2	1.6	
	* PS31	8.28	2.38	0.2	0.2	0.6	0.6	
	* PS42	11.46	3.18	0.2	0.2	0.6	1.0	
	CT22	6.35	3.18	0.4	0.8	1.2	—	F Тип расточного инструмента (E028)
	CT32	9.52	3.18	0.4	0.8	1.2	—	
	* PT21	5.11	2.38	0.2	0.2	0.6	—	
	* PT32	8.28	3.18	0.2	0.2	0.6	—	
	* PT42	10.85	3.18	0.3	0.3	0.7	—	
	DCSVN32	9.52	3.18	0.8	1.2	—	—	Державка С ДВОЙНЫМ ПРИЖИМОМ (E019) БОРШТАНГА С ДВОЙНЫМ ЗАХВАТОМ (E017)
	ESS42	12.70	3.18	0.8	0.8	1.2	1.6	
	EST32	9.52	3.18	0.4	0.8	1.2	—	
	EST43	12.70	4.76	0.4	0.8	1.2	—	
	LLSCN3T3	9.52	3.97	0.4	0.4	0.8	0.8	Державка LL типа (C008)
	LLSCN33	9.52	4.76	0.4	0.4	0.8	0.8	Державка LL типа (C008)
	LLSCN42	12.70	3.18	0.8	0.8	1.2	1.2	БОРШТАНГА С ДВОЙНЫМ ЗАХВАТОМ (E015)
	LLSCN53	15.87	4.76	1.2	1.2	1.6	1.6	P Тип расточного инструмента (E038)
	LLSCN63	19.05	4.76	1.2	1.2	1.6	1.6	HSK Державка (H001)
	* LLSCP42	12.70	3.18	0.8	0.8	1.2	1.2	БОРШТАНГА С ДВОЙНЫМ ЗАХВАТОМ (E015)
	* LLSCP63	19.05	4.76	1.2	1.2	1.6	1.6	P Тип расточного инструмента (E038)
								HSK Державка (H001)
	LLSDN32	9.52	3.18	0.8	1.2	—	—	Державка С ДВОЙНЫМ ПРИЖИМОМ (C010)
	LLSDN42	12.70	3.18	0.8	1.2	—	—	Державка LL типа (C010)
	LLSDN43	12.70	4.76	0.8	1.2	—	—	БОРШТАНГА С ДВОЙНЫМ ЗАХВАТОМ (E015)
	LLSDN53	15.87	4.76	1.2	1.6	—	—	P Тип расточного инструмента (E038)
	* LLSDP42	12.70	3.18	0.8	1.2	—	—	БОРШТАНГА С ДВОЙНЫМ ЗАХВАТОМ (E015)
	LLSRN103	8.3	3.18	—	—	—	—	Державка LL типа (C026)
	LLSRN123	9.8	3.18	—	—	—	—	HSK Державка (H001)
	LLSRN164	13.6	4.76	—	—	—	—	
	LLSRN204	17.3	4.76	—	—	—	—	
	LLSRN256	22.0	6.35	—	—	—	—	
	LLSRN326	28.0	6.35	—	—	—	—	
	LLSSN32	9.52	3.18	0.8	0.8	1.2	1.2	БОРШТАНГА С ДВОЙНЫМ ЗАХВАТОМ (E016) P Тип расточного инструмента (E037)
	LLSSN33	9.52	4.76	0.8	0.8	1.2	1.2	
	LLSSN42	12.70	3.18	0.8	0.8	1.2	1.6	
	LLSSN53	15.87	4.76	1.2	1.2	1.6	1.6	
	LLSSN63	19.05	4.76	1.2	1.2	1.6	2.0	
	LLSSN84	25.40	6.35	1.6	1.6	2.4	2.4	
* LLSSP42	12.70	3.18	0.8	0.8	1.2	1.6	БОРШТАНГА С ДВОЙНЫМ ЗАХВАТОМ (E016)	

N

ЗАПАСНЫЕ ЧАСТИ

ЗАПАСНЫЕ ЧАСТИ

ОПОРНАЯ ПЛАСТИНА

Геометрия	Обозначение	Размеры (мм)						Державка
		MPCA	MPCB	MPCC	MPCD	MPCE	MPCF	
	LLSTE32	7.6	3.18	0.4	0.4	0.4	—	Державка LL типа (☉C016) БОРШТАНГА С ДВОЙНЫМ ЗАХВАТОМ (☉E016) P Тип расточного инструмента (☉E037)
	LLSTN32	9.52	3.18	0.4	0.8	1.2	—	
	LLSTN33	9.52	4.76	0.4	0.8	1.2	—	
	LLSTN42	12.70	3.18	0.4	0.8	1.2	—	
	LLSTN53	15.87	4.76	0.8	1.2	1.6	—	
	* LLSTP32	9.52	3.18	0.4	0.8	1.2	—	
	* LLSTP42	12.70	3.18	0.4	0.8	1.2	—	Державка LL типа (☉C022) Державка С ДВОЙНЫМ ПРИЖИМОМ (☉C022) БОРШТАНГА С ДВОЙНЫМ ЗАХВАТОМ (☉E017)
	LLSWN32	9.52	3.18	0.4	0.8	1.2	—	
	LLSWN3T3	9.52	3.97	0.4	0.8	1.2	—	
	LLSWN42	12.70	3.18	0.4	0.8	1.2	—	
	* LLSWP32	9.52	3.18	0.4	0.8	1.2	—	
	* LLSWP42	12.70	3.18	0.4	0.8	1.2	—	
	MHS532R/L	9.4	15.7	4.5	0.8	0.8	—	
	MHS533R/L	9.4	15.7	4.5	1.2	1.2	—	
	MHS534R/L	9.4	15.7	4.5	1.6	1.6	—	
	MHS543R/L	9.4	15.7	6.5	1.2	1.2	—	
<p>Отверстие в этом элементе смещено от центра.</p>	MLCP42	12.58	3.18	1.2	1.2	1.2	1.2	P Тип расточного инструмента (☉E038)
	<p>Отверстие в этом элементе смещено от центра.</p>	MLDP42	12.56	3.18	1.2	1.2	—	—
<p>Отверстие в этом элементе смещено от центра.</p>		MLSP42	12.63	3.18	1.2	1.2	1.2	1.2
	<p>Отверстие в этом элементе смещено от центра.</p>	MLTP32	9.50	3.18	1.2	1.2	1.2	—
		MSCN63	18.8	4.76	1.6	1.6	1.6	1.6
		MSSN63	18.8	4.76	1.6	1.6	1.6	1.6
		CT32T1	9.525	15.03	3.18	—	—	—
	* PT32T1R	8.28	13.34	3.18	—	—	—	
	* PT32T2R	8.28	13.19	3.18	—	—	—	

N

ЗАПАСНЫЕ ЧАСТИ

Геометрия	Обозначение	Размеры (мм)						Державка
		MPCA	MPCB	MPCC	MPCD	MPCE	MPCF	
	PV321	9.52	3.18	0.4	0.4	—	—	Державка MP типа (C019)
	PV322	9.52	3.18	0.8	0.8	—	—	
	PV323	9.52	3.18	1.2	1.2	—	—	
	SPSVN32	8.06	3.18	0.3	0.3	—	—	Державка SP типа (C030) HSK Державка (H001)
	STASX400N	11.00	3.00	0.4	0.4	0.4	0.4	ASX400 (K068)
	STASX445N	10.76	3.00	—	—	—	—	ASX445 (K026)
	STBS500N	12.7	3.18	0.8	0.8	0.8	0.8	
	WPSTN33	9.3	4.76	0.8	0.4	1.2	—	Державка WP типа (C017)
	WPSTN43	12.50	4.76	0.8	0.4	1.2	—	
	* WPSWC43	12.50	4.76	0.4	0.8	1.2	—	Державка WP типа (C023)
	WPSWN43	12.50	4.76	0.4	0.8	1.2	—	

ЗАПАСНЫЕ ЧАСТИ

ШТИФТ ОПОРНОЙ ПЛАСТИНЫ И ЗАЖИМНОЙ РЫЧАГ

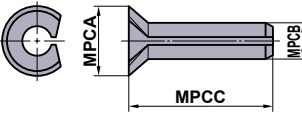
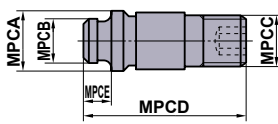
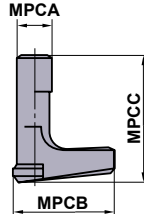
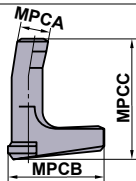
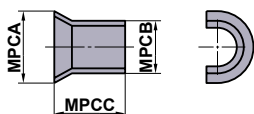
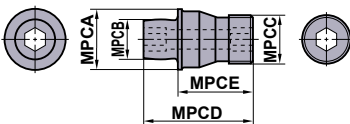
Геометрия	Обозначение	Размеры (мм)					Державка
		MPCA	MPCB	MPCC	MPCD	MPCE	
	BCP141	3.0	1.4	5.6	—	—	Державка SP типа (☉C030) F Тип расточного инструмента (☉E028) HSK Державка (☉H013)
	BCP201	4.3	2	7.4	—	—	
	BCP202	4.3	2	6.4	—	—	
	BCP251	4.8	2.5	7.4	—	—	
	BCP252	4.8	2.5	6.4	—	—	
	BCP301	5.3	3	7.4	—	—	
	CCP33	6.5	3.66	M5×0.8	18.5	3	WP Державка (☉C017)
	CCP34	7.5	5.0	M6×1.0	18.5	3	
	CCP44	7.5	5.0	M5×0.8	14.2	3	
	LLCL12S	2.1	9.3	5.6	—	—	Державка LL типа (☉C016) P Тип расточного инструмента (☉E037) HSK Державка (☉H001)
	LLCL13	3.6	10	12.5	—	—	
	LLCL13S	3.6	10	7.8	—	—	
	LLCL14	4.7	13.4	13.2	—	—	
	LLCL14S	4.7	13.6	12.2	—	—	
	LLCL15	6.0	19	17	—	—	
	LLCL16	7.5	20.8	21	—	—	
	LLCL18	8.6	25.4	25.2	—	—	
	LLCL23	3.6	12.0	11.5	—	—	
	LLCL23S	3.6	11.6	9.5	—	—	
	LLCL24	4.7	16.2	14.8	—	—	
	LLCL25	6.0	17.1	17	—	—	
	LLCL110	3.0	10.7	11.6	—	—	Державка LL типа (☉C008)
	LLCL112	3.5	13	13.5	—	—	
	LLCL116	4.5	18.5	18	—	—	
	LLCL120	5.6	20.3	19	—	—	
	LLCL125	6	24	24	—	—	
	LLCL132	8	30	27	—	—	
	LLP13	5.55	4.85	5.3	—	—	Державка С ДВОЙНЫМ ПРИЖИМОМ (☉C008) БОРШТАНГА С ДВОЙНЫМ ЗАХВАТОМ (☉E015) P Тип расточного инструмента (☉E037) HSK Державка (☉H001)
	LLP14	7.25	6.55	5.8	—	—	
	LLP15	8.8	8.05	8.6	—	—	
	LLP16	10.85	9.85	11.1	—	—	
	LLP18	15.35	13.05	12.0	—	—	
	LLP23	5.55	4.85	6.8	—	—	
	LLP24	7.25	6.55	9.1	—	—	
	MP6	11.9	7.8	M10×1	22.1	15	Державка С ДВОЙНЫМ ПРИЖИМОМ (☉C009) (для тяжелого резания заготовок)

ЗАПИРАЮЩИЙ ШТИФТ

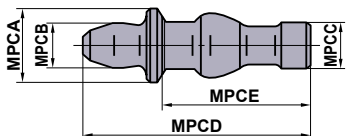
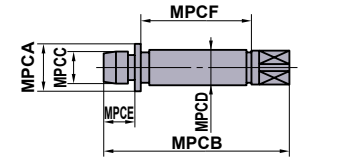
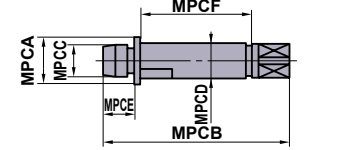
Геометрия	Обозначение	Размеры (мм)						Державка
		MPCA	MPCB	MPCD	MPCCE	MPCF	MPCG	
	P11S	6	3.7	4	17	11.1	—	Державка MP типа (C019)
	P21S	7.5	4.9	4.5	17.2	11.5	—	
	P221US	4	18	2.11	3.5	3.3	7.7	
	P333WS	5.75	24	3.64	5.0	4.9	11.3	
	P434W	7.75	30	5.03	7.0	4.9	16.8	

ПРИХВАТ

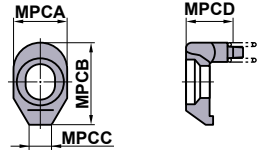
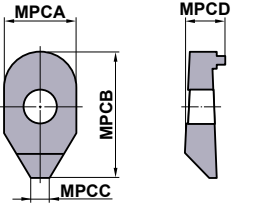
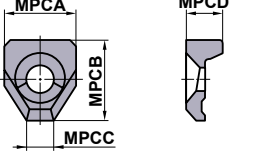
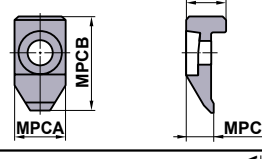
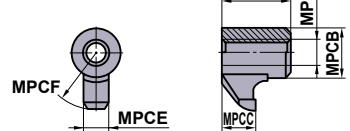
Геометрия	Обозначение	Размеры (мм)						Державка
		MPCA	MPCB	MPCD	MPCCE	MPCF	MPCG	
	AMS3	7	12	3	3.3	—	—	Профильная державка (C032) AJX (K180)
	AMS4	9	13.5	3	3.8	—	—	
	AMS5	10	15	3.5	5	—	—	
	CA142	8	15	4	7	—	—	
	CA150	9	16	4.5	7	—	—	
	CA151	10	17	5	7	—	—	
	CA152	10	19	5	7	—	—	
	CA153	10	24	5	7	—	—	
	CA161	13	20	6	8	—	—	
	CA162	13	24	6	8	—	—	
	CA163	13	27	6	8	—	—	
	CA181	16	30	8	10	—	—	
CA183	16	37	8	10	—	—		
	CCK13	15	18.5	6	9	—	—	Державка WP типа (C017)
	CCK14	19	22	8	9.5	—	—	
	CCTC1	13	25	7	10.2	—	—	
	CK231	M6×1	8	4	7.5	4.5	9.5	
	CK232	M6×1	8	4.5	8	4.5	11.5	
	CK341	M8×1	11	5.5	13.5	6	13.5	
	CK342	M8×1	11	6	14	6	16.5	

N

ЗАПАСНЫЕ ЧАСТИ

ЗАПАСНЫЕ ЧАСТИ

ПРИХВАТ

ЗАПАСНЫЕ ЧАСТИ

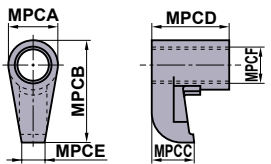
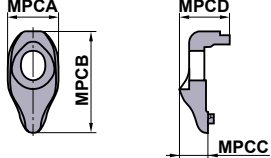
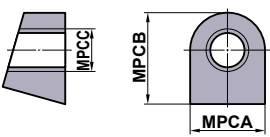
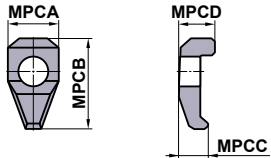
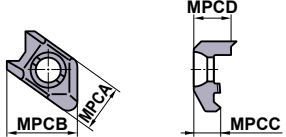
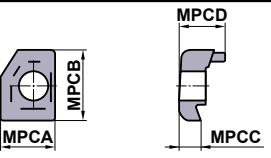
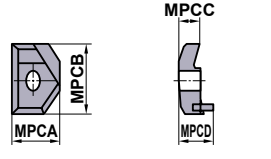
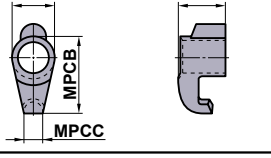
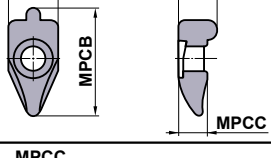
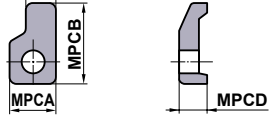
Геометрия	Обозначение	Размеры (мм)						Державка
		MPCA	MPCB	MPCC	MPCD	MPCE	MPCF	
	CKW6	10.9	22.5	9.2	16.8	5	M8×1	Державка С ДВОЙНЫМ ПРИЖИМОМ (☉C009) (для тяжелого резания заготовок)
	DCK2211 DCK2613 DCK3113	11 13 13	22 26.5 31	6.57 7.35 9	11.1 12.9 14.5	— — —	— — —	Державка С ДВОЙНЫМ ПРИЖИМОМ (☉C008) БОРШТАНГА С ДВОЙНЫМ ЗАХВАТОМ (☉E015) HSK Державка (☉H001)
	KGC1	12.0	15.0	M7×0.75	—	—	—	
	LK1	8	14.3	4.5	5.9	—	—	
	MHK5NR/L	15.5	23.5	8.1	12.1	—	—	
	MTK1R/L	13	17.5	5	12	—	—	Державка MG типа (☉F124) Державка MT типа (☉G024) HSK Державка (☉H001)
	MTK2R/L	18	28	7	14	—	—	
	SETK51 SETK61	6.8 8.9	14.5 18.1	2.9 4.1	8 8.6	— —	— —	Державка MMTE типа (☉G019) Державка MMTI типа (☉G026) HSK Державка (☉H001)
	SRK1R	9.4	21	5.5	7.5	—	—	
	UCR	12	24	8	7	—	—	

ЭЛЕМЕНТ СТРУЖКОЛОМА

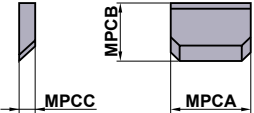
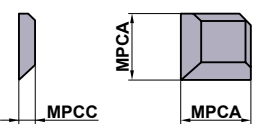
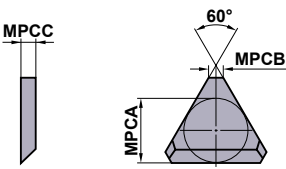
Геометрия	Обозначение	Размеры (мм)					Державка
		MPCA	MPCB	MPCC	IC	LBB	
	CBS3	9.4	8.0	1.5	9.525	1.5	
	CBS4	12.6	9.2	2.5	12.70	3.5	
	CBS4N	12.6	10.2	2.5	12.70	2.5	
	CBS4F	12.6	11.2	2.5	12.70	1.5	
	CBS6	18.9	14.6	2.5	19.05	4.5	
	CBS6F	18.9	17.6	2.5	19.05	1.5	
	CBS3D	8.0	—	1.5	9.525	1.5	
	CBS4D	10.2	—	2.5	12.70	2.5	
	CBT2N	5.67	1.4	1.5	6.35	1.0	F Тип расточного инструмента (E028) *Для позитивных пластин ширина стружколома на 0.5 мм больше, чем указано в списке.
	CBT3	7.20	1.4	2.5	9.525	3.5	
	CBT3N	7.87	1.4	2.5	9.525	2.5	
	CBT3F	8.53	1.4	2.5	9.525	1.5	
	CBT4N	11.07	1.4	2.5	12.70	2.5	
	CBT4F	11.73	1.4	2.5	12.70	1.5	

Геометрия	Обозначение	Размеры (мм)			MPCD (мм)	Державка
		MPCA	MPCB	MPCC		
	CBT3106	11.5	10.6	2.0	2.5—3.0	
	CBT3113	11.5	11.3	2.0	1.5—2.0	
	CBT3120	11.5	12	2.0	0.75—1.25	

N

ЗАПАСНЫЕ ЧАСТИ

ПРОТИВОЗАДИРНАЯ СМАЗКА

ПРОТИВОЗАДИРНАЯ СМАЗКА

Внешний вид	Обозначение	Наличие	Объем (g)
	MK1K	★	20
	MK1KS	★	3

Z

ЗАПАСНЫЕ ЧАСТИ

★ : Со склада в Японии.

ТЕХНИЧЕСКИЕ ДАННЫЕ

СООТВЕТСТВИЕ ISO13399.....	P002
УСТРАНЕНИЕ ПРОБЛЕМ ПРИ СВЕРЛЕНИИ	P006
ИЗНОС СВЕРЛА И ПОВРЕЖДЕНИЕ РЕЖУЩЕЙ КРОМКИ	P007
ХАРАКТЕРИСТИКИ СВЕРЛ И ТЕХНИЧЕСКОЕ ОПИСАНИЕ	P008
ФОРМУЛЫ ДЛЯ СВЕРЛЕНИЯ	P011
СРАВНИТЕЛЬНАЯ ТАБЛИЦА МАТЕРИАЛОВ	P012
ШЕРОХОВАТОСТЬ ПОВЕРХНОСТИ.....	P016
СРАВНИТЕЛЬНАЯ ТАБЛИЦА ТВЕРДОСТИ.....	P017
ТАБЛИЦА ПРЕДЕЛЬНЫХ ОТКЛОНЕНИЙ ПОСАДОК (ОТВЕРСТИЯ)	P018
ТАБЛИЦА ПРЕДЕЛЬНЫХ ОТКЛОНЕНИЙ ПОСАДОК (СИСТЕМА ВАЛ) ...	P020
ДИАМЕТР СВЕРЛА ПОД РЕЗЬБОВОЕ ОТВЕРСТИЕ	P022
РАЗМЕРЫ ОТВЕРСТИЯ ПОД БОЛТ С ЦИЛИНДРИЧЕСКОЙ ГОЛОВКОЙ	P023
МЕЖДУНАРОДНАЯ СИСТЕМА ЕДИНИЦ	P024



СООТВЕТСТВИЕ ISO13399

Таблица условных обозначений в соответствии с ISO 13399

Буквенные

Источник: стандарт ISO 13399

URL : <https://www.iso.org/search/x/query/13399>

ISO 13399: условные обозначения	Значение
ADJLX	Максимальный предел регулировки
ADJRG	Диапазон регулировки
ALF	Радиальный задний угол
ALP	Осевой задний угол
AN	Главный задний угол
ANN	Вспомогательный задний угол
APMX	Максимальная глубина резания
AS	Задний угол на зачистной кромке
ASP	Выступание установочного винта
AZ	Максимальная глубина вертикального врезания
B	Ширина хвостовика
BBD	Сбалансировано конструктивно
BCH	Длина фаски при вершине
BD	Диаметр корпуса
BDX	Максимальная диаметр корпуса
BHCC	Количество циклов сверления отверстий под болты
BHTA	Половинный угол конуса корпуса
BMC	Материал корпуса
BS	Длина зачистной кромки
BSR	Радиус кромки зачистной пластины
CASC	Размер вставки
CB	Количество поверхностей для стружколома
CBDP	Глубина крепежного отверстия
CBMD	Обозначение производителя стружколома
CBP	Характеристики стружколома
CCMS	Соединение со стороны станка
CCWS	Соединение со стороны заготовки
CCP	Характеристики фасочной вершины
CDI	Диаметр резания пластины
CDX	Максимальный глубина резания
CEATC	Тип угла режущего инструмента
CECC	Состояние режущей кромки
CEDC	Количество режущих кромок
CF	Фаска при цековании
CHW	Ширина угловой фаски
CICT	Количество режущих элементов
CNC	Количество углов
CND	Диаметр отверстия для подвода СОЖ
CNSC	Тип подвода СОЖ к инструменту
CNT	Размер резьбы входного отверстия для подвода СОЖ
CP	Давление СОЖ
CRE	Радиус цекования
CRKS	Размер резьбы центрального болта
CSP	Характеристики подвода СОЖ
CTP	Характеристики покрытия
CTX	Перемещение режущей кромки по оси X
CTY	Перемещение режущей кромки по оси Y
CUTDIA	Максимальный диаметр отрезки заготовки
CUB	Основание соединительного устройства
CW	Ширина резания
CWX	Максимальный Ширина резания
CXD	Диаметр выпускного отверстия СОЖ

ISO 13399: условные обозначения	Значение
CXSC	Тип выпускного отверстия СОЖ
CZC	Код размера соединения
D1	Диаметр отверстия
DAH	Диаметр отверстия под головку винта
DAXN	Минимальный наружный диаметр торцевой канавки
DAXX	Максимальный наружный диаметр торцевой канавки
DBC	Диаметр окружности болта
DC	Диаметр резания
DCB	Диаметр отверстия соединения
DCBN	Минимальный диаметр отверстия соединения
DCBX	Максимальный диаметр отверстия соединения
DCC	Тип конфигурации конструкции
DCCB	Диаметр расточенного отверстия соединения
DCIN	Внутренний диаметр резания
DCINN	Минимальный внутренний диаметр резания
DCINX	Максимальный внутренний диаметр резания
DCN	Минимальный диаметр отверстия
DCON	Диаметр соединения
DCONMS	Диаметр соединения со стороны станка
DCONWS	Диаметр соединения со стороны заготовки
DCSC	Размер диаметра резания
DCSFMS	Диаметр соединения со стороны станка
DCX	Максимальная диаметр отверстия
DF	Диаметр фланца
DHUB	Диаметр ступицы
DMIN	Минимальный диаметр отверстия
DMM	Диаметр хвостовика
DN	Диаметр шейки
DRVA	Угол поворота
EPSR	Угол напайки в плане
FHA	Угол подъема стружечной канавки
FHCSA	Угол фаски крепежного отверстия
FHCSD	Диаметр фаски крепежного отверстия
FLGT	Толщина фланца
FMT	Тип формы
FXHLP	Характеристики крепежного отверстия
GAMF	Радиальный передний угол
GAMN	Передний угол
GAMO	Ортогональный передний угол
GAMP	Осевой передний угол
GAN	Передний угол пластины
H	Высота хвостовика
HA	Теоретическая высота резьбы
HAND	Напр.
HBH	Высота смещения основания головки
HBKL	Длина смещения головки назад
HBKW	Ширина смещения головки назад
HBL	Длина смещения головки вниз
HC	Фактическая высота резьбы
HF	Функциональная высота
HHUB	Высота ступицы
HTB	Высота корпуса
IC	Диаметр вписанной окружности
IFS	Тип крепления пластины
IIC	Тип присоединения пластины
INSL	Длина пластины
KAPR	Главный угол в плане
KCH	Угол угловой фаски

ТЕХНИЧЕСКИЕ ДАННЫЕ

ISO 13399: условные обозначения	Значение
KRINS	Главный угол в плане в норм сечении
KWW	Ширина шпоночного паза
KYP	Характеристики шпоночной канавки
L	Рабочая длина (максимально рекомендуемая)
LAMS	Угол наклона
LB	Длина корпуса
LBB	Ширина стружколома
LBX	Максимальный длина корпуса
LCCB	Глубина расточенного отверстия соединения
LCF	Длина стружечной канавки
LDRED	Длина корпуса уменьшенного диаметра
LE	Эффективная длина режущей кромки
LF	Функциональная длина
LFA	Размер LF
LH	Длина головки
LPR	Программируемая длина
LS	Длина хвостовика
LSC	Длина закрепления
LSCN	Минимальный длина закрепления
LSCX	Максимальная длина закрепления
LTA	Длина LTA (длина от MCS до CRP)
LU	Рабочая длина (макс. рекомендуемая)
LUX	Максимальная рабочая длина
M	Размер m
M2	Расстояние между диаметром впадин и радиусом при вершине пластины с задним углом
MHA	Угол монтажного отверстия
MHD	Присоединительные размеры
MHH	Высота монтажного отверстия
MIID	Обозначение мастер пластины
MTP	Тип зажима
NCE	Количество режущих частей
NOF	Количество канавок
NOI	Количество индексаций пластины
NT	Количество зубьев
OAH	Общая высота
OAL	Общая длина
OAW	Общая ширина
PDPT	Глубина профиля пластины
PDX	Вылет профиля ex
PDY	Вылет профиля ey
PFS	Тип профиля
PL	Длина режущей части
PNA	Угол профиля резьбы
PRFRAD	Радиус профиля
PSIR	Главный угол в плане
PSIRL	Левый угол наклона режущей кромки
PSIRR	Правый угол наклона режущей кромки
RAL	Левый задний угол
RAR	Правый задний угол
RCP	Характеристики закругленной вершины
RE	Радиус при вершине
REL	Левый радиус при вершине
RER	Правый радиус при вершине
RMPX	Максимальный угол врезания
RPMX	Максимальная частота вращения
S	Толщина пластины
S1	Толщина пластины
SC	Общая толщина пластины
SDL	Длина ступени
SIG	Двойной угол в плане

ISO 13399: условные обозначения	Значение
SSC	Размер гнезда под пластину
SX	Форма поперечного сечения хвостовика
TC	Класс допуска пластины
TCE	Режущая кромка с насадкой
TCTR	Класс допуска резьбы
TD	Диаметр резьбы
THFT	Профиль резьбы
THL	Длина нарезки резьбы
THLGTH	Длина резьбы
THSC	Форма державки
THUB	Толщина ступицы
TP	Шаг резьбы
TPI	Нитей резьбы на дюйм
TPIN	Нитей резьбы на дюйм, минимум
TPIX	Нитей резьбы на дюйм, максимум
TPN	Минимальный шаг резьбы
TPT	Тип профиля резьбы
TPX	Максимальная шаг резьбы
TQ	Крутящий момент
TSYC	Тип инструмента
TTP	Тип резьбы
ULDR	Отношение полезной длины к диаметру
UST	Система измерений
W1	Ширина пластины
WEP	Характеристики кромки зачистной пластины
WF	Функциональная ширина
WF2	Расстояние между начальной точкой резания и ближайшей опорной поверхностью токарного инструмента
WFS	Вспомогательная функциональная ширина
WT	Вес элемента
ZEFF	Количество эффективных торцевых режущих кромок
ZEPF	Число эффективных периферийных режущих кромок
ZNC	Количество центральных режущих кромок
ZNF	Количество пластин с установкой на торец
ZNP	Количество периферийных пластин

Таблица условных обозначений в соответствии с ISO 13399

ISO 13399 Условные обозначения	Значение
CIP	Система координат технологического процесса
CRP	Контрольная точка резания
CSW	Система координат со стороны заготовки
MCS	Система координат для монтажа
PCS	Главная система координат

ИЗНОС СВЕРЛА И ПОВРЕЖДЕНИЕ РЕЖУЩЕЙ КРОМКИ

■ УСЛОВИЯ ИЗНОСА СВЕРЛА

На рисунке изображён износ режущей кромки сверла. Возникновение и степень износа варьируются в зависимости от материалов заготовки и условий резания в конкретном случае. Тем не менее, сильнее всего выражается износ ленточки, который и определяет срок службы сверла. При последующей переточке следует полностью удалить следы износа. Если степень износа высока, следует убрать больше материала, чтобы восстановить режущую кромку.

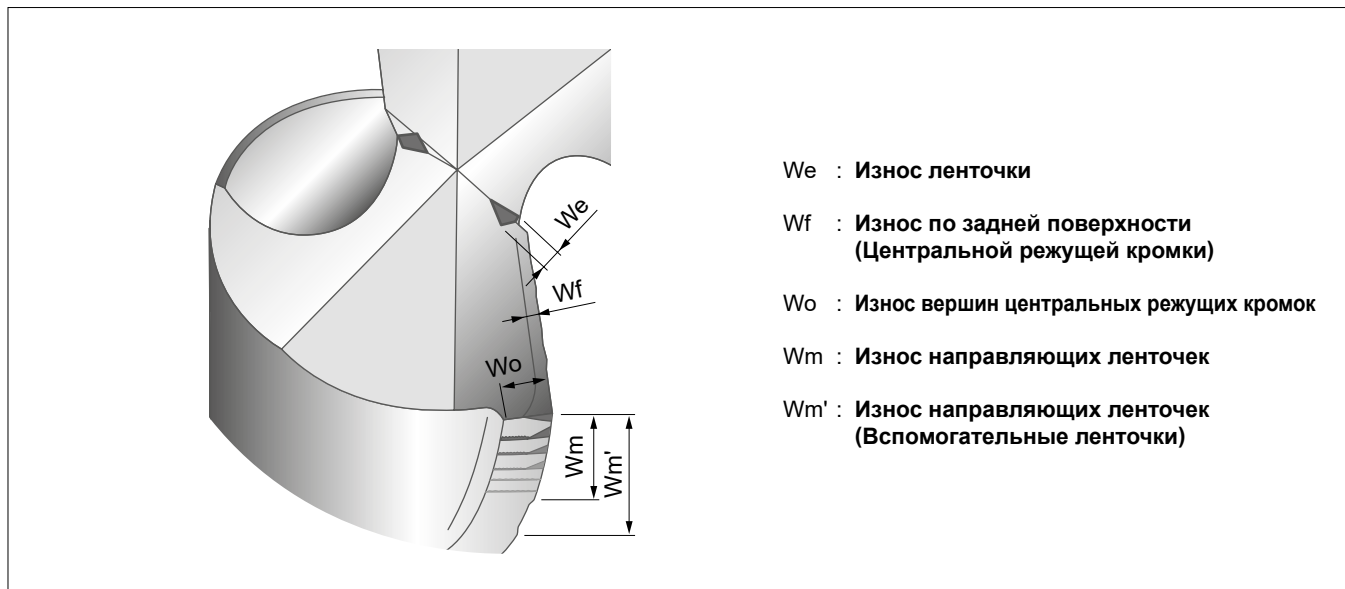

Р

ТЕХНИЧЕСКИЕ ДАННЫЕ

■ ПОВРЕЖДЕНИЕ РЕЖУЩИХ КРОМОК

При сверлении режущая кромка может быть повреждена из-за выкрашивания, излома или по какой-либо другой причине. В таких случаях важно точно выяснить и оценить причину повреждения и принять меры для ее устранения.

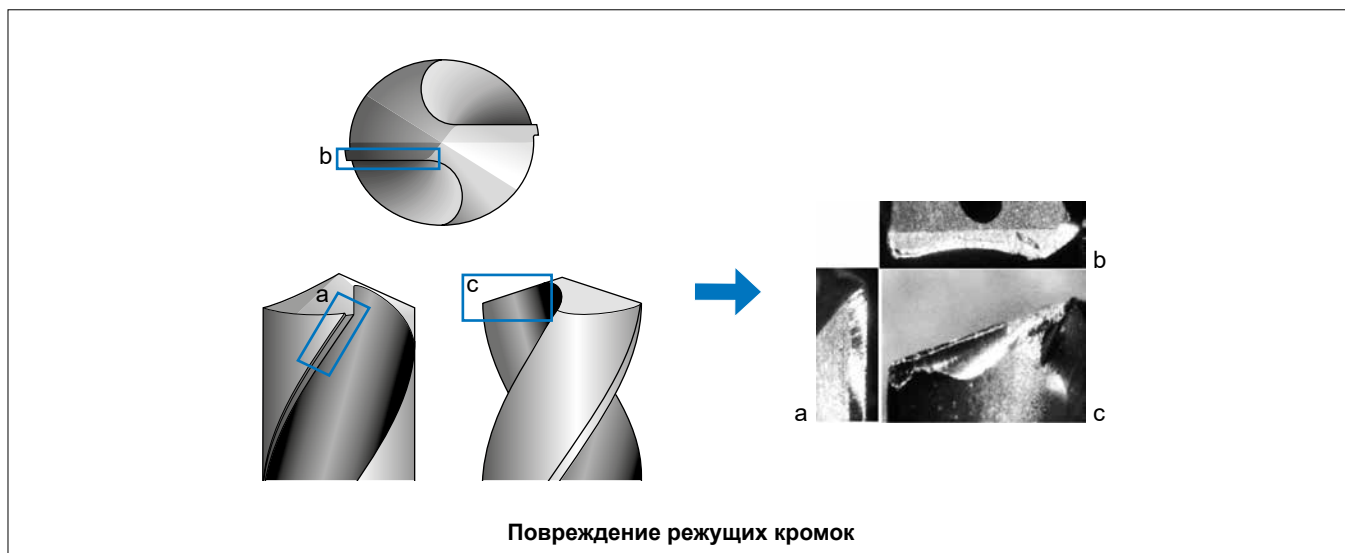

ХАРАКТЕРИСТИКИ СВЕРЛ И ТЕХНИЧЕСКОЕ ОПИСАНИЕ

■ ТЕРМИНОЛОГИЯ

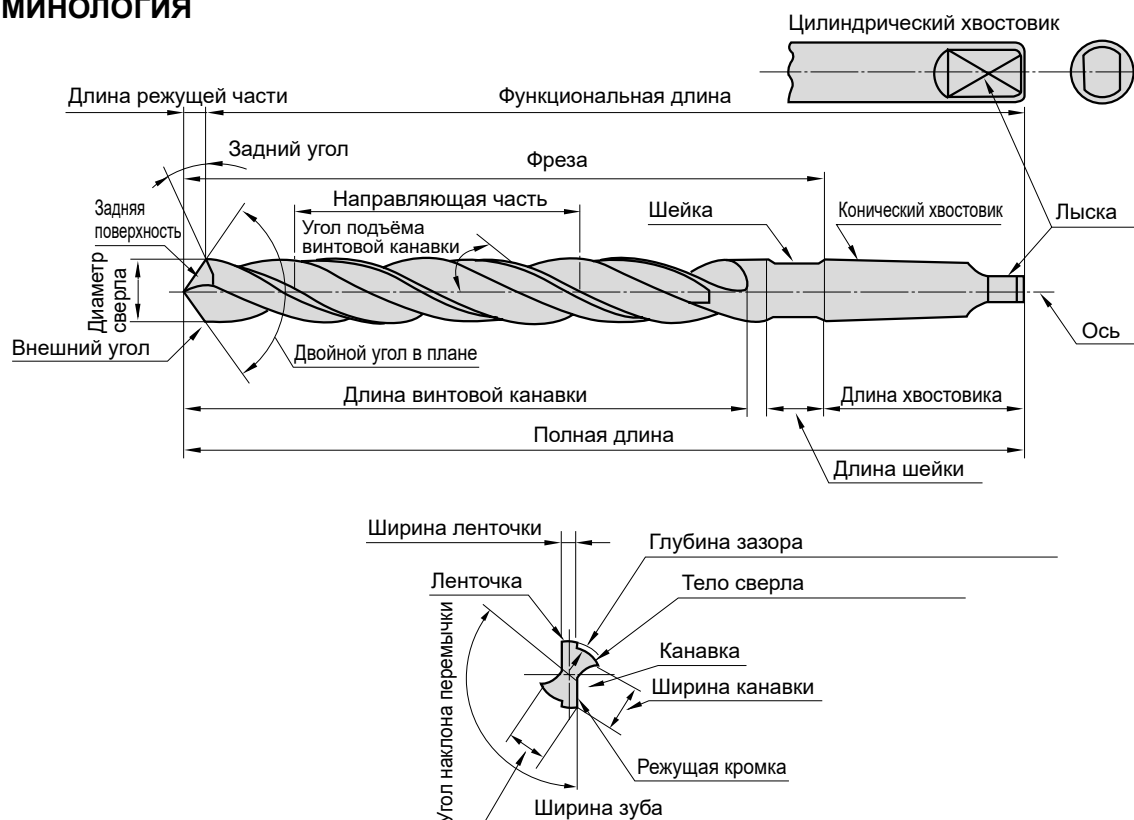

ТЕХНИЧЕСКИЕ ДАННЫЕ

■ ЭЛЕМЕНТЫ СВЕРЛА И ХАРАКТЕРИСТИКА РЕЗАНИЯ

Угол подъёма винтовой канавки	<p>Это наклон спиральной канавки относительно направления оси сверла, который соответствует переднему углу режущей кромки вблизи к периферии сверла. Передний угол изменяется по длине режущей кромки, уменьшаясь по мере приближения к центру.</p> <p>Высокозакаленный материал Малый ◀•• Главный передний угол ••▶ Большой Мягкий материал (Алюминий, и т. д.)</p>
Длина зуба	<p>Определяется глубиной отверстия, длиной втулки и возможными переточками. Так как от ее величины сильно зависит стойкость инструмента, длину рабочей части необходимо, по возможности, минимизировать.</p>
Угол при вершине	<p>Стандартное значение угла при вершине сверла составляет 118° и может быть изменено в соответствии с условиями конкретного применения.</p> <p>Мягкий материал с хорошей обрабатываемостью Малый ◀•• Двойной угол в плане ••▶ Большой Для твёрдых материалов и высокоэффективной обработки</p>
Толщина сердцевины	<p>Это важный элемент, который определяет жёсткость сверла и способность удаления стружки. Толщина сердцевины сверла выбирается в соответствии с видом обработки.</p> <p>Низкое сопротивление резанию Низкая жесткость Хорошее удаление стружки Материал с хорошей обрабатываемостью</p> <p>Тонкая ◀•• Толщина сердцевины ••▶ Толстая</p> <p>Высокое сопротивление резанию Высокая жесткость Плохое удаление стружки Высокозакаленный материал, пересекающиеся отверстия и т.д.</p>
Ленточка	<p>Ленточки определяют диаметр сверла и работают как направляющие в процессе сверления. Ширина ленточек выбирается в зависимости от величины трения со стенкой отверстия.</p> <p>Плохая направляющая способность Малый ◀•• Ширина ленточки ••▶ Большой Хорошая направляющая способность</p>
Диаметр обратного конуса	<p>Для уменьшения трения со стенкой отверстия, рабочая часть сверла имеет небольшой обратный уклон. Уклон обычно представляется как величина уменьшения диаметра относительно длины режущей части и составляет приблизительно 0.04–0.1 мм. Большее значение выбирается для высокоэффективных свёрл и для заготовок, в которых сверлятся несквозные отверстия.</p>

■ ГЕОМЕТРИЯ РЕЖУЩЕЙ КРОМКИ И ЕЕ ВЛИЯНИЕ

Как показано в таблице ниже, можно выбрать наиболее подходящую геометрию режущей кромки для различных применений. Если подобрана наиболее подходящая геометрия режущей кромки, можно получить более высокую производительность и более высокую точность отверстия.

● Форма режущей кромки

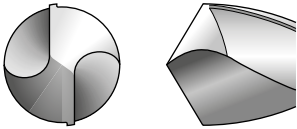
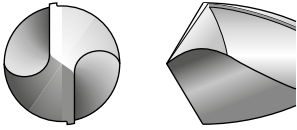
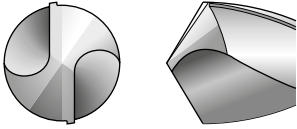
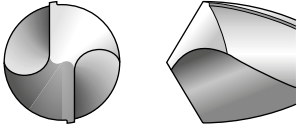
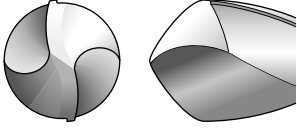
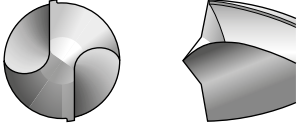
Форма заточки	Форма	Характеристики и их влияние	Область применения
Коническая		<ul style="list-style-type: none"> • Коническая задняя поверхность. Задний угол увеличивается в направлении центра сверла. 	<ul style="list-style-type: none"> • Общего применения
Плоская		<ul style="list-style-type: none"> • Плоская задняя поверхность. • Простая переточка. 	<ul style="list-style-type: none"> • Преимущественно для сверл малого диаметра
Трёхплоскостная		<ul style="list-style-type: none"> • Из-за отсутствия перемычки, при сверлении отверстий малых диаметров развивается большая центробежная сила, которая приводит к нежелательному увеличению значения диаметра отверстия. • Для переточки требуется специальный шлифовальный станок • Плоское шлифование по трём плоскостям. 	<ul style="list-style-type: none"> • Для отверстий, требующих высокой точности размера и расположения отверстия.
Спиральная		<ul style="list-style-type: none"> • Для увеличения заднего угла вблизи центра сверла шлифование по конусу сочетают с нерегулярным шагом спирали. • Благодаря S-образной режущей кромке достигается точность обработки. 	<ul style="list-style-type: none"> • Для отверстий, требующих высокой точности
Радиальная		<ul style="list-style-type: none"> • Режущая кромка шлифуется радиально для распределения нагрузки. • Высокая точность и качество поверхности отверстия. • При сверлении сквозных отверстий на выходе возможно образование мелких заусенцев • Требуется специальный шлифовальный станок 	<ul style="list-style-type: none"> • Чугун, Алюминиевые сплавы • Для чугунных плит • Сталь
Центральная точка		<ul style="list-style-type: none"> • Эта геометрия отличается двухступенчатым углом заострения, обеспечивающим лучшее центрирование и уменьшение сил резания на выходе из отверстия. 	<ul style="list-style-type: none"> • Для сверления отверстий в тонких листах



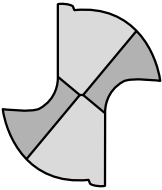
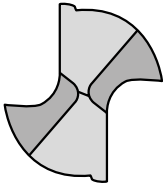
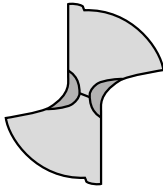
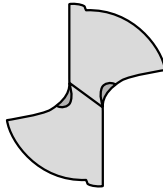

■ ПОДТОЧКА ПЕРЕМОЧКИ

Передний угол уменьшается в направлении центра сверла и его значение изменяется до отрицательного у перемычки. В процессе сверления поперечная кромка под действием осевой силы сминает металл оказывая 50–70% сопротивления резанию. Подточка перемычки очень эффективна в плане снижения сопротивления резанию, добавления режущей кромки в области перемычки и лучшего врезания.

Форма				
	X Тип	XR Тип	S Тип	N Тип
Характеристики	Существенно снижается осевая нагрузка, улучшается производительность врезания. Эффективна при толстой сердцевине сверла.	Врезание немного хуже, чем у типа X, но при этом режущая кромка прочнее, что позволяет выполнять большой диапазон работ.	Процесс резания облегчается. Это широко используемая форма подточки.	Эффективна при сравнительно толстой сердцевине сверла.
Основные применения	Общая обработка и сверление глубоких отверстий.	Выше стойкость. Общая обработка и сверление нержавеющей сталей.	Общая обработка стали, чугуна и цветных металлов.	Сверление глубоких отверстий.

ХАРАКТЕРИСТИКИ СВЕРЛ И ТЕХНИЧЕСКОЕ ОПИСАНИЕ

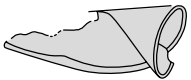
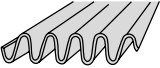
■ СТРУЖКА ПОСЛЕ СВЕРЛЕНИЯ

Типы стружек	Форма	Особенности и простота распределения
Коническая спиральная		Стружка, срезаемая режущей кромкой, сворачивается в канавку в спираль. Стружка такого вида возникает при сверлении вязких материалов на низкой подаче. Если стружка обрывается после нескольких оборотов, то процесс стружколомания удовлетворительный.
Длинная стружка		Длинная стружка выходит без скручивания и наматывается на сверло.
В виде лопасти		Это стружка, обломанная зубом сверла и стенкой просверленного отверстия. Она получается при высокой подаче.
Сегментная		Коническая спиральная стружка обламывается стенкой просверленного отверстия из-за её недостаточной пластичности, только после достижения определённой длины с большим шагом. Отлично удаляется из зоны резания.
Зигзагообразная		Стружка, которая сжимается в складку из-за формы зуба и свойств материала. Является основной причиной забивки стружечной канавки сверла.
Иглообразная		Стружка ломается из-за вибрации или когда хрупкий материал завивается с малым радиусом. Процесс стружколомания сравнительно удовлетворительный, но такая стружка может забить стружечную канавку.

ФОРМУЛЫ ДЛЯ СВЕРЛЕНИЯ

■ СКОРОСТЬ РЕЗАНИЯ (V_c)

$$V_c = \frac{\pi \cdot DC \cdot n}{1000} \text{ (м/мин)}$$

V_c (м/мин): Скорость резания
 π (3.14) : Пи
 DC (мм) : Диаметр сверла
 n (мин⁻¹) : Частота вращения шпинделя

*Деление на 1000 для перевода из мм в м.

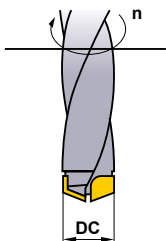

(Пример) Какова скорость резания, если частота вращения шпинделя 1350мин⁻¹, а диаметр сверла 12мм ?

(Решение) Подставляем $\pi=3.14$, $DC=12$, $n=1350$ в формулу

$$V_c = \frac{\pi \cdot DC \cdot n}{1000} = \frac{3.14 \times 12 \times 1350}{1000} = 50.9 \text{ м/мин}$$

Скорость резания 50.9м/мин.

■ ПОДАЧА ГЛАВНОГО ШПИНДЕЛЯ (V_f)

$$V_f = fr \cdot n \text{ (мм/мин)}$$

V_f (мм/мин) : Подача главного шпинделя (ось Z)
 fr (мм/об) : Подача на оборот
 n (мин⁻¹) : Частота вращения шпинделя

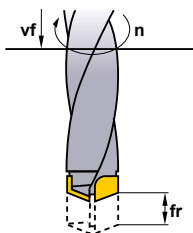

(Пример) Определите минутную подачу шпинделя (V_f), если подача на оборот равна 0.2мм/об, а частота вращения шпинделя 1350мин⁻¹ ?

(Решение) Подставляем $fr=0.2$, $n=1350$ в формулу

$$V_f = fr \cdot n = 0.2 \times 1350 = 270 \text{ мм/мин}$$

Минутная подача шпинделя равна 270мм/мин.

■ ВРЕМЯ ОБРАБОТКИ (T_c)

$$T_c = \frac{ld \cdot i}{n \cdot fr}$$

T_c (мин) : Время обработки
 n (мин⁻¹) : Частота вращения
 ld (мм) : Глубина сверления
 fr (мм/об) : Подача на оборот
 i : Количество отверстий

(Пример) Сколько времени потребуется, чтобы просверлить отверстие длиной 30мм в легированной стали, если скорость резания 50м/мин, а подача 0.15мм/об ?

(Решение) Частота вращения $n = \frac{50 \times 1000}{15 \times 3.14} = 1061.57 \text{ мин}^{-1}$

$$T_c = \frac{30 \times 1}{1061.57 \times 0.15} = 0.188$$

$$= 0.188 \times 60 \approx 11.3 \text{ sec}$$

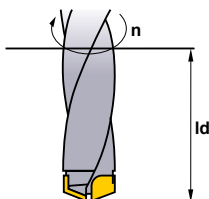

: Частота вращения шпинделя

СРАВНИТЕЛЬНАЯ ТАБЛИЦА МАТЕРИАЛОВ

■ УГЛЕРОДИСТАЯ СТАЛЬ

Германия		Великобритания		Франция	Италия	Испания	Швеция	Япония	США	Китай
W-nr.	DIN	BS	EN	AFNOR	UNI	UNE	SS	JIS	AISI/SAE	GB
1.0038	RSt.37-2	4360 40 C	–	E 24-2 Ne	–	–	1311	STKM 12A STKM 12C	A570.36	15
1.0401	C15	080M15	–	CC12	C15, C16	F.111	1350	–	1015	15
1.0402	C22	050A20	2C	CC20	C20, C21	F.112	1450	–	1020	20
1.0715	9SMn28	230M07	1A	S250	CF9SMn28	F.2111 11SMn28	1912	SUM22	1213	Y15
1.0718	9SMnPb28	–	–	S250Pb	CF9SMnPb28	11SMnPb28	1914	SUM22L	12L13	–
1.0722	10SPb20	–	–	10PbF2	CF10Pb20	10SPb20	–	–	–	–
1.0736	9SMn36	240M07	1B	S300	CF9SMn36	12SMn35	–	–	1215	Y13
1.0737	9SMnPb36	–	–	S300Pb	CF9SMnPb36	12SMnP35	1926	–	12L14	–
1.1141	Ck15	080M15	32C	XC12	C16	C15K	1370	S15C	1015	15
1.1158	Ck25	–	–	–	–	–	–	S25C	1025	25
1.8900	StE380	4360 55 E	–	–	FeE390KG	–	2145	–	A572-60	–
1.0501	C35	060A35	–	CC35	C35	F.113	1550	–	1035	35
1.0503	C45	080M46	–	CC45	C45	F.114	1650	–	1045	45
1.0726	35S20	212M36	8M	35MF4	–	F210G	1957	–	1140	–
1.1157	40Mn4	150M36	15	35M5	–	–	–	–	1039	40Mn
1.1167	36Mn5	–	–	40M5	–	36Mn5	2120	SMn438(H)	1335	35Mn2
1.1170	28Mn6	150M28	14A	20M5	C28Mn	–	–	SCMn1	1330	30Mn
1.1183	Cf35	060A35	–	XC38TS	C36	–	1572	S35C	1035	35Mn
1.1191	Ck45	080M46	–	XC42	C45	C45K	1672	S45C	1045	Ck45
1.1213	Cf53	060A52	–	XC48TS	C53	–	1674	S50C	1050	50
1.0535	C55	070M55	9	–	C55	–	1655	–	1055	55
1.0601	C60	080A62	43D	CC55	C60	–	–	–	1060	60
1.1203	Ck55	070M55	–	XC55	C50	C55K	–	S55C	1055	55
1.1221	Ck60	080A62	43D	XC60	C60	–	1678	S58C	1060	60Mn
1.1274	Ck101	060A96	–	XC100	–	F.5117	1870	–	1095	–
1.1545	C105W1	BW1A	–	Y105	C36KU	F.5118	1880	SK3	W1	–
1.1545	C105W1	BW2	–	Y120	C120KU	F.515	2900	SUP4	W210	–

■ ЛЕГИРОВАННАЯ СТАЛЬ

Германия		Великобритания		Франция	Италия	Испания	Швеция	Япония	США	Китай
W-nr.	DIN	BS	EN	AFNOR	UNI	UNE	SS	JIS	AISI/SAE	GB
1.0144	St.44.2	4360 43 C	–	E28-3	–	–	1412	SM400A, SM400B SM400C	A573-81	–
1.0570	St52-3	4360 50 B	–	E36-3	Fe52BFN Fe52CFN	–	2132	SM490A, SM490B SM490C	–	–
1.0841	St52-3	150M19	–	20MC5	Fe52	F.431	2172	–	5120	–
1.0904	55Si7	250A53	45	55S7	55Si8	56Si7	2085	–	9255	55Si2Mn
1.0961	60SiCr7	–	–	60SC7	60SiCr8	60SiCr8	–	–	9262	–
1.3505	100Cr6	534A99	31	100C6	100Cr6	F.131	2258	SUJ2	ASTM 52100	Gr15, 45G
1.5415	15Mo3	1501-240	–	15D3	16Mo3KW	16Mo3	2912	–	ASTM A204Gr.A	–
1.5423	16Mo5	1503-245-420	–	–	16Mo5	16Mo5	–	–	4520	–
1.5622	14Ni6	–	–	16N6	14Ni6	15Ni6	–	–	ASTM A350LF5	–
1.5662	X8Ni9	1501-509-510	–	–	X10Ni9	XBNI09	–	–	ASTM A353	–
1.5710	36NiCr6	640A35	111A	35NC6	–	–	–	SNC236	3135	–
1.5732	14NiCr10	–	–	14NC11	16NiCr11	15NiCr11	–	SNC415(H)	3415	–
1.5752	14NiCr14	655M13	36A	12NC15	–	–	–	SNC815(H)	3415, 3310	–
1.6523	21NiCrMo2	805M20	362	20NCD2	20NiCrMo2	20NiCrMo2	2506	SNCM220(H)	8620	–
1.6546	40NiCrMo22	311-Type 7	–	–	40NiCrMo2(KB)	40NiCrMo2	–	SNCM240	8740	–
1.6587	17CrNiMo6	820A16	–	18NCD6	–	14NiCrMo13	–	–	–	–
1.7015	15Cr3	523M15	–	12C3	–	–	–	SCr415(H)	5015	15Cr

Германия		Великобритания		Франция	Италия	Испания	Швеция	Япония	США	Китай
W-нр.	DIN	BS	EN	AFNOR	UNI	UNE	SS	JIS	AISI/SAE	GB
1.7045	42Cr4	–	–	–	–	42Cr4	2245	SCr440	5140	40Cr
1.7176	55Cr3	527A60	48	55C3	–	–	–	SUP9(A)	5155	20CrMn
1.7262	15CrMo5	–	–	12CD4	–	12CrMo4	2216	SCM415(H)	–	–
1.7335	13CrMo4 4	1501-620Gr27	–	15CD3.5 15CD4.5	14CrMo45	14CrMo45	–	–	ASTM A182 F11, F12	–
1.7380	10CrMo910	1501-622 Gr31, 45	–	12CD9 12CD10	12CrMo9 12CrMo10	TU.H	2218	–	ASTM A182 F.22	–
1.7715	14MoV63	1503-660-440	–	–	–	13MoCrV6	–	–	–	–
1.8523	39CrMoV13 9	897M39	40C	–	36CrMoV12	–	–	–	–	–
1.6511	36CrNiMo4	816M40	110	40NCD3	38NiCrMo4(KB)	35NiCrMo4	–	–	9840	–
1.6582	34CrNiMo6	817M40	24	35NCD6	35NiCrMo6(KB)	–	2541	–	4340	40CrNiMoA
1.7033	34Cr4	530A32	18B	32C4	34Cr4(KB)	35Cr4	–	SCr430(H)	5132	35Cr
1.7035	41Cr4	530M40	18	42C4	41Cr4	42Cr4	–	SCr440(H)	5140	40Cr
1.7131	16MnCr5	(527M20)	–	16MC5	16MnCr5	16MnCr5	2511	–	5115	18CrMn
1.7218	25CrMo4	1717CDS110 708M20	–	25CD4	25CrMo4(KB)	55Cr3	2225	SCM420 SCM430	4130	30CrMn
1.7220	34CrMo4	708A37	19B	35CD4	35CrMo4	34CrMo4	2234	SCM432 SCCRM3	4137 4135	35CrMo
1.7223	41CrMo4	708M40	19A	42CD4TS	41CrMo4	42CrMo4	2244	SCM 440	4140 4142	40CrMoA
1.7225	42CrMo4	708M40	19A	42CD4	42CrMo4	42CrMo4	2244	SCM440(H)	4140	42CrMo 42CrMnMo
1.7361	32CrMo12	722M24	40B	30CD12	32CrMo12	F.124.A	2240	–	–	–
1.8159	50CrV4	735A50	47	50CV4	50CrV4	51CrV4	2230	SUP10	6150	50CrVA
1.8509	41CrAlMo7	905M39	41B	40CAD6 40CAD2	41CrAlMo7	41CrAlMo7	2940	–	–	–
1.2067	100Cr6	BL3	–	Y100C6	–	100Cr6	–	–	L3	CrV, 9SiCr
1.2419	105WCr6	–	–	105WC13	100WCr6 107WCr5KU	105WCr5	2140	SKS31 SKS2, SKS3	–	CrWMo
1.2713	55NiCrMoV6	BH224/5	–	55NCDV7	–	F.520.S	–	SKT4	L6	5CrNiMo
1.5662	X8Ni9	1501-509	–	–	X10Ni9	XBNi09	–	–	ASTM A353	–
1.5680	12Ni19	–	–	Z18N5	–	–	–	–	2515	–
1.6657	14NiCrMo134	832M13	36C	–	15NiCrMo13	14NiCrMo131	–	–	–	–
1.2080	X210Cr12	BD3	–	Z200C12	X210Cr13KU X250Cr12KU	X210Cr12	–	SKD1	D3 ASTM D3	Cr12
1.2601	X153CrMoV12	BD2	–	–	X160CrMoV12	–	–	SKD11	D2	Cr12MoV
1.2363	X100CrMoV5	BA2	–	Z100CDV5	X100CrMoV5	F.5227	2260	SKD12	A2	Cr5Mo1V
1.2344	X40CrMoV51 X40CrMoV51	BH13	–	Z40CDV5	X35CrMoV05KU X40CrMoV51KU	X40CrMoV5	2242	SKD61	H13 ASTM H13	40CrMoV5
1.2436	X210CrW12	–	–	–	X215CrW121KU	X210CrW12	2312	SKD2	–	–
1.2542	45WCrV7	BS1	–	–	45WCrV8KU	45WCrSi8	2710	–	S1	–
1.2581	X30WCrV93	BH21	–	Z30WCV9	X28W09KU	X30WCrV9	–	SKD5	H21	30WCrV9
1.2601	X165CrMoV12	–	–	–	X165CrMoV12KU	X160CrMoV12	2310	–	–	–
1.2833	100V1	BW2	–	Y1105V	–	–	–	SKS43	W210	V
1.3255	S 18-1-2-5	BT4	–	Z80WKCV	X78WCo1805KU	HS18-1-1-5	–	SKH3	T4	W18Cr4VCo5
1.3355	S 18-0-1	BT1	–	Z80WCV	X75W18KU	HS18-0-1	–	SKH2	T1	–
1.3401	G-X120Mn12	Z120M12	–	Z120M12	XG120Mn12	X120MN12	–	SCMnH/1	–	–
1.4718	X45CrSi93	401S45	52	Z45CS9	X45CrSi8	F.322	–	SUH1	HW3	X45CrSi93
1.3343	S6-5-2	4959BA2	–	Z40CSD10	15NiCrMo13	–	2715	SUH3	D3	–
1.3343	S6/5/2	BM2	–	Z85WDCV	HS6-5-2-2	F.5603	2722	SKH9, SKH51	M2	–
1.3348	S 2-9-2	–	–	–	HS2-9-2	HS2-9-2	2782	–	M7	–
1.3243	S6/5/2/5	BM35	–	6-5-2-5	HS6-5-2-5	F.5613	2723	SKH55	M35	–

СРАВНИТЕЛЬНАЯ ТАБЛИЦА МАТЕРИАЛОВ

■ НЕРЖАВЕЮЩАЯ СТАЛЬ (ФЕРРИТНАЯ,МАРТЕНСИТНАЯ)

Германия		Великобритания		Франция	Италия	Испания	Швеция	Япония	США	Китай
W-nr.	DIN	BS	EN	AFNOR	UNI	UNE	SS	JIS	AISI/SAE	GB
1.4000	X7Cr13	403S17	—	Z6C13	X6Cr13	F.3110	2301	SUS403	403	0Cr13 1Cr12
1.4001	X7Cr14	—	—	—	—	F.8401	—	—	—	—
1.4005	X12CrS13	416S21	—	Z11CF13	X12CrS13	F.3411	2380	SUS416	416	—
1.4006	X10Cr13	410S21	56A	Z10C14	X12Cr13	F.3401	2302	SUS410	410	1Cr13
1.4016	X8Cr17	430S15	60	Z8C17	X8Cr17	F.3113	2320	SUS430	430	1Cr17
1.4027	G-X20Cr14	420C29	56B	Z20C13M	—	—	—	SCS2	—	—
1.4034	X46Cr13	420S45	56D	Z40CM Z38C13M	X40Cr14	F.3405	2304	SUS420J2	—	4Cr13
1.4003	—	405S17	—	Z8CA12	X6CrAl13	—	—	—	405	—
1.4021	—	420S37	—	Z8CA12	X20Cr13	—	2303	—	420	—
1.4057	X22CrNi17	431S29	57	Z15CNi6.02	X16CrNi16	F.3427	2321	SUS431	431	1Cr17Ni2
1.4104	X12CrMoS17	—	—	Z10CF17	X10CrS17	F.3117	2383	SUS430F	430F	Y1Cr17
1.4113	X6CrMo17	434S17	—	Z8CD17.01	X8CrMo17	—	2325	SUS434	434	1Cr17Mo
1.4313	X5CrNi134	425C11	—	Z4CND13.4M	(G)X6CrNi304	—	2385	SCS5	CA6-NM	—
1.4724	X10CrA113	403S17	—	Z10C13	X10CrA112	F.311	—	SUS405	405	0Cr13Al
1.4742	X10CrA118	430S15	60	Z10CAS18	X8Cr17	F.3113	—	SUS430	430	Cr17
1.4747	X80CrNiSi20	443S65	59	Z80CSN20.02	X80CrSiNi20	F.320B	—	SUH4	HNV6	—
1.4762	X10CrA124	—	—	Z10CAS24	X16Cr26	—	2322	SUH446	446	2Cr25N
1.4871	X53CrMnNiN219	349S54	—	Z52CMN21.09	X53CrMnNiN219	—	—	SUH35	EV8	5Cr2Mn9Ni4N
1.4521	X1CrMoTi182	—	—	—	—	—	2326	—	S44400	—
1.4922	X20CrMoV12-1	—	—	—	X20CrMoNi1201	—	2317	—	—	—
1.4542	—	—	—	Z7CNU17-04	—	—	—	—	630	—

■ НЕРЖАВЕЮЩАЯ СТАЛЬ (АУСТЕНИТНАЯ)

Германия		Великобритания		Франция	Италия	Испания	Швеция	Япония	США	Китай
W-nr.	DIN	BS	EN	AFNOR	UNI	UNE	SS	JIS	AISI/SAE	GB
1.4306	X2CrNi1911	304S11	—	Z2CN18.10	X2CrNi18.11	—	2352	SUS304L	304L	0Cr19Ni10
1.4350	X5CrNi189	304S11	58E	Z6CN18.09	X5CrNi1810	F.3551 F.3541 F.3504	2332	SUS304	304	0Cr18Ni9
1.4305	X12CrNiS188	303S21	58M	Z10CNF18.09	X10CrNiS18.09	F.3508	2346	SUS303	303	1Cr18Ni9MoZr
—	—	304C12	—	Z3CN19.10	—	—	2333	SUS304L	—	—
1.4306	X2CrNi189	304S12	—	Z2CrNi1810	X2CrNi18.11	F.3503	2352	SCS19	304L	—
1.4310	X12CrNi177	—	—	Z12CN17.07	X12CrNi1707	F.3517	2331	SUS301	301	Cr17Ni7
1.4311	X2CrNiN1810	304S62	—	Z2CN18.10	—	—	2371	SUS304LN	304LN	—
1.4401	X5CrNiMo1810	316S16	58J	Z6CND17.11	X5CrNiMo1712	F.3543	2347	SUS316	316	0Cr17Ni11Mo2
1.4308	G-X6CrNi189	304C15	—	Z6CN18.10M	—	—	—	SCS13	—	—
1.4408	G-X6CrNiMo1810	316C16	—	—	—	F.8414	—	SCS14	—	—
1.4581	G-X5CrNiMoNb1810	318C17	—	Z4CNDNb1812M	XG8CrNiMo1811	—	—	SCS22	—	—
1.4429	X2CrNiMoN1813	—	—	Z2CND17.13	—	—	2375	SUS316LN	316LN	0Cr17Ni13Mo
1.4404	—	316S13	—	Z2CND17.12	X2CrNiMo1712	—	2348	—	316L	—
1.4435	X2CrNiMo1812	316S13	—	Z2CND17.12	X2CrNiMo1712	—	2353	SCS16 SUS316L	316L	0Cr27Ni12Mo3
1.4436	—	316S13	—	Z6CND18-12-03	X8CrNiMo1713	—	2343, 2347	—	316	—
1.4438	X2CrNiMo1816	317S12	—	Z2CND19.15	X2CrNiMo1816	—	2367	SUS317L	317L	00Cr19Ni13Mo
1.4539	X1NiCrMo	—	—	Z6CNT18.10	—	—	2562	—	UNS V 0890A	—
1.4541	X10CrNiTi189	321S12	58B	Z6CNT18.10	X6CrNiTi1811	F.3553 F.3523	2337	SUS321	321	1Cr18Ni9Ti
1.4550	X10CrNiNb189	347S17	58F	Z6CNNb18.10	X6CrNiNb1811	F.3552 F.3524	2338	SUS347	347	1Cr18Ni11Nb
1.4571	X10CrNiMoTi1810	320S17	58J	Z6CNDT17.12	X6CrNiMoTi1712	F.3535	2350	—	316Ti	Cr18Ni12Mo2T
1.4583	X10CrNiMoNb1812	—	—	Z6CNDNb1713B	X6CrNiMoNb1713	—	—	—	318	Cr17Ni12Mo3Mb

Германия		Великобритания		Франция	Италия	Испания	Швеция	Япония	США	Китай
W-nr.	DIN	BS	EN	AFNOR	UNI	UNE	SS	JIS	AISI/SAE	GB
1.4828	X15CrNiSi2012	309S24	—	Z15CNS20.12	X6CrNi2520	—	—	SUH309	309	1Cr23Ni13
1.4845	X12CrNi2521	310S24	—	Z12CN2520	X6CrNi2520	F.331	2361	SUH310	310S	0Cr25Ni20
1.4406	X10CrNi18.08	—	58C	Z1NCDU25.20	—	F.8414	2370	SCS17	308	—
1.4418	X4CrNiMo165	—	—	Z6CND16-04-01	—	—	—	—	—	—
1.4568	—	316S111	—	Z8CNA17-07	X2CrNiMo1712	—	—	—	17-7PH	—
1.4504	—	—	—	—	—	—	—	—	—	—
1.4563	—	—	—	Z1NCDU31-27-03 Z1CNDU20-18-06AZ	—	—	2584 2378	—	NO8028 S31254	—
1.4878	X12CrNiTi189	321S32	58B, 58C	Z6CNT18.12B	X6CrNiTi18.11	F.3523	—	SUS321	321	1Cr18Ni9Ti

■ ЖАРОПРОЧНЫЕ СТАЛИ

Германия		Великобритания		Франция	Италия	Испания	Швеция	Япония	США	Китай
W-nr.	DIN	BS	EN	AFNOR	UNI	UNE	SS	JIS	AISI/SAE	GB
1.4864	X12NiCrSi3616	—	—	Z12NCS35.16	—	—	—	SUH330	330	—
1.4865	G-X40NiCrSi3818	330C11	—	—	XG50NiCr3919	—	—	SCH15	HT, HT 50	—

■ СЕРЫЙ ЧУГУН

Германия		Великобритания		Франция	Италия	Испания	Швеция	Япония	США	Китай
W-nr.	DIN	BS	EN	AFNOR	UNI	UNE	SS	JIS	AISI/SAE	GB
—	—	—	—	—	—	—	0100	—	—	—
—	GG 10	—	—	Ft 10 D	—	—	0110	FC100	No 20 B	—
0.6015	GG 15	Grade 150	—	Ft 15 D	G15	FG15	0115	FC150	No 25 B	HT150
0.6020	GG 20	Grade 220	—	Ft 20 D	G20	—	0120	FC200	No 30 B	HT200
0.6025	GG 25	Grade 260	—	Ft 25 D	G25	FG25	0125	FC250	No 35 B	HT250
—	—	—	—	—	—	—	—	—	No 40 B	—
0.6030	GG 30	Grade 300	—	Ft 30 D	G30	FG30	0130	FC300	No 45 B	HT300
0.6035	GG 35	Grade 350	—	Ft 35 D	G35	FG35	0135	FC350	No 50 B	HT350
0.6040	GG 40	Grade 400	—	Ft 40 D	—	—	0140	—	No 55 B	HT400
0.6660	GGL NiCr202	L-NiCuCr202	—	L-NC 202	—	—	0523	—	A436 Type 2	—

■ КОВКИЙ ЧУГУН

Германия		Великобритания		Франция	Италия	Испания	Швеция	Япония	США	Китай
W-nr.	DIN	BS	EN	AFNOR	UNI	UNE	SS	JIS	AISI/SAE	GB
0.7040	GGG 40	SNG 420/12	—	FCS 400-12	GS 370-17	FGE 38-17	07 17-02	FCD400	60-40-18	QT400-18
—	GGG 40.3	SNG 370/17	—	FGS 370-17	—	—	07 17-12	—	—	—
0.7033	GGG 35.3	—	—	—	—	—	07 17-15	—	—	—
0.7050	GGG 50	SNG 500/7	—	FGS 500-7	GS 500	FGE 50-7	07 27-02	FCD500	80-55-06	QT500-7
0.7660	GGG NiCr202	Grade S6	—	S-NC202	—	—	07 76	—	A43D2	—
—	GGG NiMn137	L-NiMn 137	—	L-MN 137	—	—	07 72	—	—	—
—	GGG 60	SNG 600/3	—	FGS 600-3	—	—	07 32-03	FCD600	—	QT600-3
0.7070	GGG 70	SNG 700/2	—	FGS 700-2	GS 700-2	FGS 70-2	07 37-01	FCD700	100-70-03	QT700-18

■ КОВКИЙ ЧУГУН

Германия		Великобритания		Франция	Италия	Испания	Швеция	Япония	США	Китай
W-nr.	DIN	BS	EN	AFNOR	UNI	UNE	SS	JIS	AISI/SAE	GB
—	—	8 290/6	—	MN 32-8	—	—	08 14	FCMB310	—	—
—	GTS-35	B 340/12	—	MN 35-10	—	—	08 15	FCMW330	32510	—
0.8145	GTS-45	P 440/7	—	Mn 450	GMN45	—	08 52	FCMW370	40010	—
0.8155	GTS-55	P 510/4	—	MP 50-5	GMN55	—	08 54	FCMP490	50005	—
—	GTS-65	P 570/3	—	MP 60-3	—	—	08 58	FCMP540	70003	—
0.8165	GTS-65-02	P 570/3	—	Mn 650-3	GMN 65	—	08 56	FCMP590	A220-70003	—
—	GTS-70-02	P 690/2	—	Mn 700-2	GMN 70	—	08 62	FCMP690	A220-80002	—

ШЕРОХОВАТОСТЬ ПОВЕРХНОСТИ

ШЕРОХОВАТОСТЬ ПОВЕРХНОСТИ

(По JIS B 0601-1994)

Тип	Обозначение	Описание	Наглядная схема
Среднее арифметическое отклонение профиля	Ra	<p>Параметр шероховатости Ra показывает величину, описываемую следующей формулой и выражаемую в микрометрах (μм). Замеряется относительная высота микронеровностей от контура профиля в направлении средней линии, за ось X берется направление средней линии, за ось Y направление увеличения профиля участка. Выразим кривую неровностей как $y=f(x)$:</p> $Ra = \frac{1}{l} \int_0^l f(x) dx$	
Наибольшая высота неровностей	Rz	<p>Rz получают как относительную высоту микронеровностей, выражаемую в микрометрах (μм) и измеряемую от контура профиля в направлении средней линии. Rz - расстояние между линией выступов профиля и линией впадин в пределах базовой длины, измеренная в направлении продольного увеличения профиля. Примечание) При вычислении Rz, ряд крайних точек без особо высоких пиков или низких впадин, которые можно считать случайными, выбирается как базовая длина. $Rz = R_p + R_v$</p>	
Высота неровностей профиля по 10 точкам	RzJIS	<p>RzJIS получают как относительную высоту, измеряемую от контура профиля в направлении средней линии. Среднеарифметическая сумма значений высот пяти наибольших выступов профиля (Yp) и глубин пяти наибольших впадин (Yv), измеренных в направлении вертикального увеличения от средней линии измеряемого участка. Данная величина выражается в микрометрах (μм).</p> $Rz_{JIS} = \frac{(Y_{p1} + Y_{p2} + Y_{p3} + Y_{p4} + Y_{p5}) + (Y_{v1} + Y_{v2} + Y_{v3} + Y_{v4} + Y_{v5})}{5}$	<p>$Y_{p1}, Y_{p2}, Y_{p3}, Y_{p4}, Y_{p5}$: пять самых высоких выступов профиля базового участка на длине l.</p> <p>$Y_{v1}, Y_{v2}, Y_{v3}, Y_{v4}, Y_{v5}$: пять самых глубоких впадин профиля базового участка на длине l.</p>

ТЕХНИЧЕСКИЕ ДАННЫЕ

■ СВЯЗЬ МЕЖДУ СРЕДНЕАРИФМЕТИЧЕСКИМ ОТКЛОНЕНИЕМ (Ra) И СТАНДАРТНЫМИ ЗНАЧЕНИЯМИ (СПРАВОЧНЫЕ ДАННЫЕ)

Среднее арифметическое отклонение профиля Ra		Макс. высота Rz	Высота неровностей профиля по 10 точкам RzJIS	Базовая длина для Rz • RzJIS l (мм)	Условный значок качества поверхности
Стандартный ряд	Базовая длина λс (мм)	Стандартный ряд			
0.012 a	0.08	0.05s	0.05z	0.08	▽▽▽▽
0.025 a		0.1 s	0.1 z		
0.05 a	0.25	0.2 s	0.2 z	0.25	
0.1 a		0.4 s	0.4 z		
0.2 a		0.8 s	0.8 z		
0.4 a	0.8	1.6 s	1.6 z	0.8	▽▽▽
0.8 a		3.2 s	3.2 z		
1.6 a		6.3 s	6.3 z		2.5
3.2 a		12.5 s	12.5 z		
6.3 a	2.5	25 s	25 z	2.5	▽▽
12.5 a		50 s	50 z		
25 a		8	100 s		100 z
50 a	200 s		200 z		
100 a	—	400 s	400 z	—	—

*Нет строгой связи между этими тремя методами.

*Ra: Определение длины Rz и Rz JIS - это значение базовой длины, умноженной в 5 раз, соответственно.

СРАВНИТЕЛЬНАЯ ТАБЛИЦА ТВЕРДОСТИ

СООТВЕТСТВИЕ ТВЕРДОСТИ СТАЛИ

Твёрдость по Бринеллю (НВ), Шарик 10мм, Нагрузка: 3000кгс		Твёрдость по Виккерсу	Твёрдость по Роквеллу					Порог твёрдости	Предел прочности (Прибл.) МПа	Твёрдость по Бринеллю (НВ), Шарик 10мм, Нагрузка: 3000кгс		Твёрдость по Виккерсу	Твёрдость по Роквеллу					Порог твёрдости	Предел прочности (Прибл.) МПа
Стандартный шарик	Вольфрамовый твёрдосплавный шарик		Шкала А, Нагрузка: 60кгс, Алмазная пирамида	Шкала В, Нагрузка: 100кгс, 1/16" дюймовый шарик	Шкала С, Нагрузка: 150кгс, Алмазная пирамида	Шкала D, Нагрузка: 100кгс, Алмазная пирамида	(HV)			(HRA)	(HRB)		(HRC)	(HRD)	(HS)	Стандартный шарик	Вольфрамовый твёрдосплавный шарик		
—	—	940	85.6	—	68.0	76.9	97	—	429	429	455	73.4	—	45.7	59.7	61	1510		
—	—	920	85.3	—	67.5	76.5	96	—	415	415	440	72.8	—	44.5	58.8	59	1460		
—	—	900	85.0	—	67.0	76.1	95	—	401	401	425	72.0	—	43.1	57.8	58	1390		
—	(767)	880	84.7	—	66.4	75.7	93	—	388	388	410	71.4	—	41.8	56.8	56	1330		
—	(757)	860	84.4	—	65.9	75.3	92	—	375	375	396	70.6	—	40.4	55.7	54	1270		
—	(745)	840	84.1	—	65.3	74.8	91	—	363	363	383	70.0	—	39.1	54.6	52	1220		
—	(733)	820	83.8	—	64.7	74.3	90	—	352	352	372	69.3	(110.0)	37.9	53.8	51	1180		
—	(722)	800	83.4	—	64.0	73.8	88	—	341	341	360	68.7	(109.0)	36.6	52.8	50	1130		
—	(712)	—	—	—	—	—	—	—	331	331	350	68.1	(108.5)	35.5	51.9	48	1095		
—	(710)	780	83.0	—	63.3	73.3	87	—	321	321	339	67.5	(108.0)	34.3	51.0	47	1060		
—	(698)	760	82.6	—	62.5	72.6	86	—	—	—	—	—	—	—	—	—	—	—	—
—	(684)	740	82.2	—	61.8	72.1	—	—	311	311	328	66.9	(107.5)	33.1	50.0	46	1025		
—	(682)	737	82.2	—	61.7	72.0	84	—	302	302	319	66.3	(107.0)	32.1	49.3	45	1005		
—	(670)	720	81.8	—	61.0	71.5	83	—	293	293	309	65.7	(106.0)	30.9	48.3	43	970		
—	(656)	700	81.3	—	60.1	70.8	—	—	285	285	301	65.3	(105.5)	29.9	47.6	—	950		
—	(653)	697	81.2	—	60.0	70.7	81	—	277	277	292	64.6	(104.5)	28.8	46.7	41	925		
—	(647)	690	81.1	—	59.7	70.5	—	—	269	269	284	64.1	(104.0)	27.6	45.9	40	895		
—	(638)	680	80.8	—	59.2	70.1	80	—	262	262	276	63.6	(103.0)	26.6	45.0	39	875		
—	630	670	80.6	—	58.8	69.8	—	—	255	255	269	63.0	(102.0)	25.4	44.2	38	850		
—	627	667	80.5	—	58.7	69.7	79	—	248	248	261	62.5	(101.0)	24.2	43.2	37	825		
—	—	677	80.7	—	59.1	70.0	—	—	241	241	253	61.8	100	22.8	42.0	36	800		
—	601	640	79.8	—	57.3	68.7	77	—	235	235	247	61.4	99.0	21.7	41.4	35	785		
—	—	640	79.8	—	57.3	68.7	—	—	229	229	241	60.8	98.2	20.5	40.5	34	765		
—	—	640	79.8	—	57.3	68.7	—	—	223	223	234	—	97.3	(18.8)	—	—	—	—	—
—	578	615	79.1	—	56.0	67.7	75	—	217	217	228	—	96.4	(17.5)	—	33	725		
—	—	607	78.8	—	55.6	67.4	—	—	212	212	222	—	95.5	(16.0)	—	—	—	—	705
—	555	591	78.4	—	54.7	66.7	73	2055	207	207	218	—	94.6	(15.2)	—	32	690		
—	—	579	78.0	—	54.0	66.1	—	2015	201	201	212	—	93.8	(13.8)	—	31	675		
—	534	569	77.8	—	53.5	65.8	71	1985	197	197	207	—	92.8	(12.7)	—	30	655		
—	—	533	77.1	—	52.5	65.0	—	1915	192	192	202	—	91.9	(11.5)	—	29	640		
—	514	547	76.9	—	52.1	64.7	70	1890	187	187	196	—	90.7	(10.0)	—	—	—	—	620
(495)	—	539	76.7	—	51.6	64.3	—	1855	183	183	192	—	90.0	(9.0)	—	28	615		
—	—	530	76.4	—	51.1	63.9	—	1825	179	179	188	—	89.0	(8.0)	—	27	600		
—	495	528	76.3	—	51.0	63.8	68	1820	174	174	182	—	87.8	(6.4)	—	—	—	—	585
(477)	—	516	75.9	—	50.3	63.2	—	1780	170	170	178	—	86.8	(5.4)	—	26	570		
—	—	508	75.6	—	49.6	62.7	—	1740	167	167	175	—	86.0	(4.4)	—	—	—	—	560
—	477	508	75.6	—	49.6	62.7	66	1740	143	143	150	—	80.8	—	—	23	505		
(461)	—	495	75.1	—	48.8	61.9	—	1680	143	143	143	—	78.7	—	—	22	490		
—	—	491	74.9	—	48.5	61.7	—	1670	137	137	143	—	76.4	—	—	21	460		
—	461	491	74.9	—	48.5	61.7	65	1670	126	126	132	—	74.0	—	—	—	—	—	450
444	—	474	74.3	—	47.2	61.0	—	1595	126	126	132	—	72.0	—	—	20	435		
—	—	472	74.2	—	47.1	60.8	—	1585	121	121	127	—	69.8	—	—	19	415		
—	444	472	74.2	—	47.1	60.8	63	1585	116	116	122	—	67.6	—	—	18	400		
—	—	472	74.2	—	47.1	60.8	—	—	111	111	117	—	65.7	—	—	15	385		

Примечание 1) Приведённые выше значения взяты из справочника AMS Metals с пределом прочности в приблизительных метрических значениях и твёрдостью по Бринеллю выше рекомендуемых значений.

Примечание 2) 1МПа=1Н/мм²

Примечание 3) Значения в скобках () редко используются и приведены как справочная информация, взятая из справочника JIS Handbook Steel I.

Р

ТЕХНИЧЕСКИЕ ДАННЫЕ

ТАБЛИЦА ПРЕДЕЛЬНЫХ ОТКЛОНЕНИЙ (ОТВЕРСТИЯ)

Интервал номинальных размеров (мм)		Квалитет и основное отклонение отверстия																
>	≤	B10	C9	C10	D8	D9	D10	E7	E8	E9	F6	F7	F8	G6	G7	H6	H7	
—	3	+180	+85	+100	+34	+45	+60	+24	+28	+39	+12	+16	+20	+8	+12	+6	+10	
		+140	+60	+60	+20	+20	+20	+14	+14	+14	+6	+6	+6	+2	+2	0	0	
3	6	+188	+100	+118	+48	+60	+78	+32	+38	+50	+18	+22	+28	+12	+16	+8	+12	
		+140	+70	+70	+30	+30	+30	+20	+20	+20	+10	+10	+10	+4	+4	0	0	
6	10	+208	+116	+138	+62	+76	+98	+40	+47	+61	+22	+28	+35	+14	+20	+9	+15	
		+150	+80	+80	+40	+40	+40	+25	+25	+25	+13	+13	+13	+5	+5	0	0	
10	14	+220	+138	+165	+77	+93	+120	+50	+59	+75	+27	+34	+43	+17	+24	+11	+18	
		+150	+95	+95	+50	+50	+50	+32	+32	+32	+16	+16	+16	+6	+6	0	0	
14	18	+244	+162	+194	+98	+117	+149	+61	+73	+92	+33	+41	+53	+20	+28	+13	+21	
		+160	+110	+110	+65	+65	+65	+40	+40	+40	+20	+20	+20	+7	+7	0	0	
18	24	+270	+182	+220	+119	+142	+180	+75	+89	+112	+41	+50	+64	+25	+34	+16	+25	
		+170	+120	+120	+80	+80	+80	+50	+50	+50	+25	+25	+25	+9	+9	0	0	
30	40	+280	+192	+230	+146	+174	+220	+90	+106	+134	+49	+60	+76	+29	+40	+19	+30	
		+180	+130	+130	+100	+100	+100	+60	+60	+60	+30	+30	+30	+10	+10	0	0	
40	50	+310	+214	+260	+208	+245	+305	+125	+148	+185	+68	+83	+106	+39	+54	+25	+40	
		+190	+140	+140	+145	+145	+145	+85	+85	+85	+43	+43	+43	+14	+14	0	0	
50	65	+320	+224	+270	+271	+320	+400	+162	+191	+240	+88	+108	+137	+49	+69	+32	+52	
		+200	+150	+150	+190	+190	+190	+110	+110	+110	+56	+56	+56	+17	+17	0	0	
65	80	+360	+257	+310	+299	+350	+440	+182	+214	+265	+98	+119	+151	+54	+75	+36	+57	
		+220	+170	+170	+170	+170	+170	+100	+100	+100	+50	+50	+50	+15	+15	0	0	
80	100	+380	+267	+320	+210	+210	+210	+125	+125	+125	+62	+62	+62	+18	+18	0	0	
		+240	+180	+180	+208	+245	+305	+125	+148	+185	+68	+83	+106	+39	+54	+25	+40	
100	120	+420	+300	+360	+470	+330	+390	+271	+320	+400	+162	+191	+240	+88	+108	+137	+49	+69
		+260	+200	+200	+310	+214	+260	+208	+245	+305	+125	+148	+185	+68	+83	+106	+39	+54
120	140	+440	+310	+370	+320	+267	+320	+210	+210	+210	+125	+125	+125	+62	+62	+62	+18	+18
		+280	+210	+210	+240	+180	+180	+208	+245	+305	+125	+148	+185	+68	+83	+106	+39	+54
140	160	+470	+330	+390	+225	+250	+280	+271	+320	+400	+162	+191	+240	+88	+108	+137	+49	+69
		+310	+230	+230	+225	+250	+280	+271	+320	+400	+162	+191	+240	+88	+108	+137	+49	+69
160	180	+525	+355	+425	+280	+280	+280	+271	+320	+400	+162	+191	+240	+88	+108	+137	+49	+69
		+340	+240	+240	+225	+250	+280	+271	+320	+400	+162	+191	+240	+88	+108	+137	+49	+69
180	200	+565	+375	+445	+299	+350	+440	+182	+214	+265	+98	+119	+151	+54	+75	+36	+57	
		+380	+260	+260	+299	+350	+440	+182	+214	+265	+98	+119	+151	+54	+75	+36	+57	
200	225	+605	+395	+465	+210	+210	+210	+125	+125	+125	+62	+62	+62	+18	+18	0	0	
		+420	+280	+280	+210	+210	+210	+125	+125	+125	+62	+62	+62	+18	+18	0	0	
225	250	+690	+430	+510	+327	+385	+480	+198	+232	+290	+108	+131	+165	+60	+83	+40	+63	
		+480	+300	+300	+327	+385	+480	+198	+232	+290	+108	+131	+165	+60	+83	+40	+63	
250	280	+750	+460	+540	+230	+230	+230	+135	+135	+135	+68	+68	+68	+20	+20	0	0	
		+540	+330	+330	+230	+230	+230	+135	+135	+135	+68	+68	+68	+20	+20	0	0	
280	315	+830	+500	+590	+327	+385	+480	+198	+232	+290	+108	+131	+165	+60	+83	+40	+63	
		+600	+360	+360	+327	+385	+480	+198	+232	+290	+108	+131	+165	+60	+83	+40	+63	
315	355	+910	+540	+630	+327	+385	+480	+198	+232	+290	+108	+131	+165	+60	+83	+40	+63	
		+680	+400	+400	+327	+385	+480	+198	+232	+290	+108	+131	+165	+60	+83	+40	+63	
355	400	+1010	+595	+690	+327	+385	+480	+198	+232	+290	+108	+131	+165	+60	+83	+40	+63	
		+760	+440	+440	+327	+385	+480	+198	+232	+290	+108	+131	+165	+60	+83	+40	+63	
400	450	+1090	+635	+730	+327	+385	+480	+198	+232	+290	+108	+131	+165	+60	+83	+40	+63	
		+840	+480	+480	+327	+385	+480	+198	+232	+290	+108	+131	+165	+60	+83	+40	+63	

Примечание 1) Значения в верхней части соответствующих ячеек показывают верхнее отклонение поля допуска, а значения в нижней части ячеек - нижнее отклонение.

Р

ТЕХНИЧЕСКИЕ ДАННЫЕ

Квалитет и основное отклонение отверстия

H8	H9	H10	JS6	JS7	K6	K7	M6	M7	N6	N7	P6	P7	R7	S7	T7	U7	X7
+14 0	+25 0	+40 0	±3	±5	0 -6	0 -10	-2 -8	-2 -12	-4 -10	-4 -14	-6 -12	-6 -16	-10 -20	-14 -24	-	-18 -28	-20 -30
+18 0	+30 0	+48 0	±4	±6	+2 -6	+3 -9	-1 -9	0 -12	-5 -13	-4 -16	-9 -17	-8 -20	-11 -23	-15 -27	-	-19 -31	-24 -36
+22 0	+36 0	+58 0	±4.5	±7	+2 -7	+5 -10	-3 -12	0 -15	-7 -16	-4 -19	-12 -21	-9 -24	-13 -28	-17 -32	-	-22 -37	-28 -43
+27 0	+43 0	+70 0	±5.5	±9	+2 -9	+6 -12	-4 -15	0 -18	-9 -20	-5 -23	-15 -26	-11 -29	-16 -34	-21 -39	-	-26 -44	-33 -51 -56
+33 0	+52 0	+84 0	±6.5	±10	+2 -11	+6 -15	-4 -17	0 -21	-11 -24	-7 -28	-18 -31	-14 -35	-20 -41	-27 -48	-	-33 -54	-46 -67 -77
+39 0	+62 0	+100 0	±8	±12	+3 -13	+7 -18	-4 -20	0 -25	-12 -28	-8 -33	-21 -37	-17 -42	-25 -50	-34 -59	-	-39 -64 -70	-51 -76 -86
+46 0	+74 0	+120 0	±9.5	±15	+4 -15	+9 -21	-5 -24	0 -30	-14 -33	-9 -39	-26 -45	-21 -51	-30 -60 -62	-42 -72 -78	-55 -85 -94	-76 -106 -121	-
+54 0	+87 0	+140 0	±11	±17	+4 -18	+10 -25	-6 -28	0 -35	-16 -38	-10 -45	-30 -52	-24 -59	-38 -73 -81	-58 -93 -101	-78 -113 -126	-111 -146 -166	-
+63 0	+100 0	+160 0	±12.5	±20	+4 -21	+12 -28	-8 -33	0 -40	-20 -45	-12 -52	-36 -61	-28 -68	-48 -88 -90 -93	-77 -117 -125 -133	-107 -147 -159 -171	-	-
+72 0	+115 0	+185 0	±14.5	±23	+5 -24	+13 -33	-8 -37	0 -46	-22 -51	-14 -60	-41 -70	-33 -79	-60 -106 -109 -113	-105 -151 -159 -169	-	-	-
+81 0	+130 0	+210 0	±16	±26	+5 -27	+16 -36	-9 -41	0 -52	-25 -57	-14 -66	-47 -79	-36 -88	-74 -126 -78 -130	-	-	-	-
+89 0	+140 0	+230 0	±18	±28	+7 -29	+17 -40	-10 -46	0 -57	-26 -62	-16 -73	-51 -87	-41 -98	-87 -144 -93 -150	-	-	-	-
+97 0	+155 0	+250 0	±20	±31	+8 -32	+18 -45	-10 -50	0 -63	-27 -67	-17 -80	-55 -95	-45 -108	-103 -166 -109 -172	-	-	-	-

ТАБЛИЦА ПРЕДЕЛЬНЫХ ОТКЛОНЕНИЙ (ВАЛ)

Интервал номинальных размеров (мм)		Квалитет и основное отклонение вала														
>	≤	b9	c9	d8	d9	e7	e8	e9	f6	f7	f8	g5	g6	h5	h6	h7
—	3	−140	−60	−20	−20	−14	−14	−14	−6	−6	−6	−2	−2	0	0	0
		−165	−85	−34	−45	−24	−28	−39	−12	−16	−20	−6	−8	−4	−6	−10
3	6	−140	−70	−30	−30	−20	−20	−20	−10	−10	−10	−4	−4	0	0	0
		−170	−100	−48	−60	−32	−38	−50	−18	−22	−28	−9	−12	−5	−8	−12
6	10	−150	−80	−40	−40	−25	−25	−25	−13	−13	−13	−5	−5	0	0	0
		−186	−116	−62	−76	−40	−47	−61	−22	−28	−35	−11	−14	−6	−9	−15
10	14	−150	−95	−50	−50	−32	−32	−32	−16	−16	−16	−6	−6	0	0	0
		−193	−138	−77	−93	−50	−59	−75	−27	−34	−43	−14	−17	−8	−11	−18
14	18	−150	−95	−50	−50	−32	−32	−32	−16	−16	−16	−6	−6	0	0	0
		−193	−138	−77	−93	−50	−59	−75	−27	−34	−43	−14	−17	−8	−11	−18
18	24	−160	−110	−65	−65	−40	−40	−40	−20	−20	−20	−7	−7	0	0	0
		−212	−162	−98	−117	−61	−73	−92	−33	−41	−53	−16	−20	−9	−13	−21
24	30	−160	−110	−65	−65	−40	−40	−40	−20	−20	−20	−7	−7	0	0	0
		−212	−162	−98	−117	−61	−73	−92	−33	−41	−53	−16	−20	−9	−13	−21
30	40	−170	−120	−80	−80	−50	−50	−50	−25	−25	−25	−9	−9	0	0	0
		−232	−182	−119	−142	−75	−89	−112	−41	−50	−64	−20	−25	−11	−16	−25
40	50	−180	−130	−119	−142	−75	−89	−112	−41	−50	−64	−20	−25	−11	−16	−25
		−242	−192	−190	−140	−100	−100	−60	−60	−60	−30	−30	−30	−10	−10	0
50	65	−190	−140	−100	−100	−60	−60	−60	−30	−30	−30	−10	−10	0	0	0
		−264	−214	−146	−174	−90	−106	−134	−49	−60	−76	−23	−29	−13	−19	−30
65	80	−200	−150	−146	−174	−90	−106	−134	−49	−60	−76	−23	−29	−13	−19	−30
		−274	−224	−220	−170	−120	−120	−72	−72	−72	−36	−36	−36	−12	−12	0
80	100	−220	−170	−120	−120	−72	−72	−72	−36	−36	−36	−12	−12	0	0	0
		−307	−257	−174	−207	−107	−126	−159	−58	−71	−90	−27	−34	−15	−22	−35
100	120	−240	−180	−174	−207	−107	−126	−159	−58	−71	−90	−27	−34	−15	−22	−35
		−327	−267	−260	−200	−145	−145	−85	−85	−85	−43	−43	−43	−14	−14	0
120	140	−260	−200	−145	−145	−85	−85	−85	−43	−43	−43	−14	−14	0	0	0
		−360	−300	−208	−245	−125	−148	−185	−68	−83	−106	−32	−39	−18	−25	−40
140	160	−280	−210	−208	−245	−125	−148	−185	−68	−83	−106	−32	−39	−18	−25	−40
		−380	−310	−310	−230	−190	−190	−110	−110	−110	−56	−56	−56	−17	−17	0
160	180	−310	−230	−190	−190	−110	−110	−110	−56	−56	−56	−17	−17	0	0	0
		−410	−330	−271	−320	−162	−191	−240	−88	−108	−137	−40	−49	−23	−32	−52
180	200	−340	−240	−271	−320	−162	−191	−240	−88	−108	−137	−40	−49	−23	−32	−52
		−455	−355	−380	−260	−170	−170	−100	−100	−100	−50	−50	−50	−15	−15	0
200	225	−380	−260	−170	−170	−100	−100	−100	−50	−50	−50	−15	−15	0	0	0
		−495	−375	−242	−285	−146	−172	−215	−79	−96	−122	−35	−44	−20	−29	−46
225	250	−420	−280	−242	−285	−146	−172	−215	−79	−96	−122	−35	−44	−20	−29	−46
		−535	−395	−480	−300	−190	−190	−110	−110	−110	−56	−56	−56	−17	−17	0
250	280	−480	−300	−190	−190	−110	−110	−110	−56	−56	−56	−17	−17	0	0	0
		−610	−430	−271	−320	−162	−191	−240	−88	−108	−137	−40	−49	−23	−32	−52
280	315	−540	−330	−271	−320	−162	−191	−240	−88	−108	−137	−40	−49	−23	−32	−52
		−670	−460	−600	−360	−210	−210	−125	−125	−125	−62	−62	−62	−18	−18	0
315	355	−600	−360	−210	−210	−125	−125	−125	−62	−62	−62	−18	−18	0	0	0
		−740	−500	−299	−350	−182	−214	−265	−98	−119	−151	−43	−54	−25	−36	−57
355	400	−680	−400	−299	−350	−182	−214	−265	−98	−119	−151	−43	−54	−25	−36	−57
		−820	−540	−760	−440	−230	−230	−135	−135	−135	−68	−68	−68	−20	−20	0
400	450	−760	−440	−230	−230	−135	−135	−135	−68	−68	−68	−20	−20	0	0	0
		−915	−595	−327	−385	−198	−232	−290	−108	−131	−165	−47	−60	−27	−40	−63
450	500	−840	−480	−327	−385	−198	−232	−290	−108	−131	−165	−47	−60	−27	−40	−63
		−995	−635													

Примечание 1) Значения в верхней части соответствующих ячеек показывают верхнее отклонение поля допуска, а значения в нижней части ячеек - нижнее отклонение.

Квалитет и основное отклонение вала

h8	h9	js5	js6	js7	k5	k6	m5	m6	n6	p6	r6	s6	t6	u6	x6
0 -14	0 -25	±2	±3	±5	+4 0	+6 0	+6 +2	+8 +2	+10 +4	+12 +6	+16 +10	+20 +14	—	+24 +18	+26 +20
0 -18	0 -30	±2.5	±4	±6	+6 +1	+9 +1	+9 +4	+12 +4	+16 +8	+20 +12	+23 +15	+27 +19	—	+31 +23	+36 +28
0 -22	0 -36	±3	±4.5	±7	+7 +1	+10 +1	+12 +6	+15 +6	+19 +10	+24 +15	+28 +19	+32 +23	—	+37 +28	+43 +34
0 -27	0 -43	±4	±5.5	±9	+9 +1	+12 +1	+15 +7	+18 +7	+23 +12	+29 +18	+34 +23	+39 +28	—	+44 +33	+51 +40 +56 +45
0 -33	0 -52	±4.5	±6.5	±10	+11 +2	+15 +2	+17 +8	+21 +8	+28 +15	+35 +22	+41 +28	+48 +35	— +54 +41	+54 +61 +48	+67 +54 +77 +64
0 -39	0 -62	±5.5	±8	±12	+13 +2	+18 +2	+20 +9	+25 +9	+33 +17	+42 +26	+50 +34	+59 +43	+64 +48 +70 +54	+76 +60 +86 +70	—
0 -46	0 -74	±6.5	±9.5	±15	+15 +2	+21 +2	+24 +11	+30 +11	+39 +20	+51 +32	+60 +41 +62 +43	+72 +53 +78 +59	+85 +66 +94 +75	+106 +87 +121 +102	—
0 -54	0 -87	±7.5	±11	±17	+18 +3	+25 +3	+28 +13	+35 +13	+45 +23	+59 +37	+73 +51 +76 +54	+93 +71 +101 +79	+113 +91 +126 +104	+146 +124 +166 +144	—
0 -63	0 -100	±9	±12.5	±20	+21 +3	+28 +3	+33 +15	+40 +15	+52 +27	+68 +43	+88 +63 +90 +65 +93 +68	+117 +92 +125 +100 +133 +108	+147 +122 +159 +134 +171 +146	—	—
0 -72	0 -115	±10	±14.5	±23	+24 +4	+33 +4	+37 +17	+46 +17	+60 +31	+79 +50	+106 +77 +109 +80 +113 +84	+151 +122 +159 +130 +169 +140	—	—	—
0 -81	0 -130	±11.5	±16	±26	+27 +4	+36 +4	+43 +20	+52 +20	+66 +34	+88 +56	+126 +94 +130 +98	—	—	—	—
0 -89	0 -140	±12.5	±18	±28	+29 +4	+40 +4	+46 +21	+57 +21	+73 +37	+98 +62	+144 +108 +150 +114	—	—	—	—
0 -97	0 -155	±13.5	±20	±31	+32 +5	+45 +5	+50 +23	+63 +23	+80 +40	+108 +68	+166 +126 +172 +132	—	—	—	—

ДИАМЕТР СВЕРЛА ПОД РЕЗЬБОВОЕ ОТВЕРСТИЕ

● Резьба метрическая, крупная

Номинал	Диаметр сверла	
	Быстрорежущая сталь	Твердый сплав
M1 ×0.25	0.75	0.75
M1.1×0.25	0.85	0.85
M1.2×0.25	0.95	0.95
M1.4×0.3	1.10	1.10
M1.6×0.35	1.25	1.30
M1.7×0.35	1.35	1.40
M1.8×0.35	1.45	1.50
M2 ×0.4	1.60	1.65
M2.2×0.45	1.75	1.80
M2.3×0.4	1.90	1.95
M2.5×0.45	2.10	2.15
M2.6×0.45	2.15	2.20
M3 ×0.5	2.50	2.55
M3.5×0.6	2.90	2.95
M4 ×0.7	3.3	3.4
M4.5×0.75	3.8	3.9
M5 ×0.8	4.2	4.3
M6 ×1.0	5.0	5.1
M7 ×1.0	6.0	6.1
M8 ×1.25	6.8	6.9
M9 ×1.25	7.8	7.9
M10×1.5	8.5	8.7
M11×1.5	9.5	9.7
M12×1.75	10.3	10.5
M14×2.0	12.0	12.2
M16×2.0	14.0	14.2
M18×2.5	15.5	15.7
M20×2.5	17.5	17.7
M22×2.5	19.5	19.7
M24×3.0	21.0	—
M27×3.0	24.0	—
M30×3.5	26.5	—
M33×3.5	29.5	—
M36×4.0	32.0	—
M39×4.0	35.0	—
M42×4.5	37.5	—
M45×4.5	40.5	—
M48×5.0	43.0	—

● Резьба метрическая, мелкая

Номинал	Диаметр сверла	
	Быстрорежущая сталь	Твердый сплав
M1 ×0.2	0.80	0.80
M1.1×0.2	0.90	0.90
M1.2×0.2	1.00	1.00
M1.4×0.2	1.20	1.20
M1.6×0.2	1.40	1.40
M1.8×0.2	1.60	1.60
M2 ×0.25	1.75	1.75
M2.2×0.25	1.95	2.00
M2.5×0.35	2.20	2.20
M3 ×0.35	2.70	2.70
M3.5×0.35	3.20	3.20
M4 ×0.5	3.50	3.55
M4.5×0.5	4.00	4.05
M5 ×0.5	4.50	4.55
M5.5×0.5	5.00	5.05
M6 ×0.75	5.30	5.35
M7 ×0.75	6.30	6.35
M8 ×1.0	7.00	7.10
M8 ×0.75	7.30	7.35
M9 ×1.0	8.00	8.10
M9 ×0.75	8.30	8.35
M10×1.25	8.80	8.90
M10×1.0	9.00	9.10
M10×0.75	9.30	9.35
M11×1.0	10.0	10.1
M11×0.75	10.3	10.3
M12×1.5	10.5	10.7
M12×1.25	10.8	10.9
M12×1.0	11.0	11.1
M14×1.5	12.5	12.7
M14×1.0	13.0	13.1
M15×1.5	13.5	13.7
M15×1.0	14.0	14.1
M16×1.5	14.5	14.7
M16×1.0	15.0	15.1
M17×1.5	15.5	15.7
M17×1.0	16.0	16.1
M18×2.0	16.0	16.3
M18×1.5	16.5	16.7
M18×1.0	17.0	17.1

Номинал	Диаметр сверла	
	Быстрорежущая сталь	Твердый сплав
M20×2.0	18.0	18.3
M20×1.5	18.5	18.7
M20×1.0	19.0	19.1
M22×2.0	20.0	—
M22×1.5	20.5	—
M22×1.0	21.0	—
M24×2.0	22.0	—
M24×1.5	22.5	—
M24×1.0	23.0	—
M25×2.0	23.0	—
M25×1.5	23.5	—
M25×1.0	24.0	—
M26×1.5	24.5	—
M27×2.0	25.0	—
M27×1.5	25.5	—
M27×1.0	26.0	—
M28×2.0	26.0	—
M28×1.5	26.5	—
M28×1.0	27.0	—
M30×3.0	27.0	—
M30×2.0	28.0	—
M30×1.5	28.5	—
M30×1.0	29.0	—
M32×2.0	30.0	—
M32×1.5	30.5	—
M33×3.0	30.0	—
M33×2.0	31.0	—
M33×1.5	31.5	—
M35×1.5	33.5	—
M36×3.0	33.0	—
M36×2.0	34.0	—
M36×1.5	34.5	—
M38×1.5	36.5	—
M39×3.0	36.0	—
M39×2.0	37.0	—
M39×1.5	37.5	—
M40×3.0	37.0	—
M40×2.0	38.0	—
M40×1.5	38.5	—
M42×4.0	38.0	—

Номинал	Диаметр сверла	
	Быстрорежущая сталь	Твердый сплав
M42×3.0	39.0	—
M42×2.0	40.0	—
M42×1.5	40.5	—
M45×4.0	41.0	—
M45×3.0	42.0	—
M45×2.0	43.0	—
M45×1.5	43.5	—
M48×4.0	44.0	—
M48×3.0	45.0	—
M48×2.0	46.0	—
M48×1.5	46.5	—
M50×3.0	47.0	—
M50×2.0	48.0	—
M50×1.5	48.5	—

Примечание 1) Размеры отверстий следует контролировать, так как точность просверленных отверстий может отличаться в зависимости от условий сверления. Если диаметр отверстия под резьбу не соответствует требуемому, следует подобрать сверло с соответствующим диаметром.

РАЗМЕРЫ ОТВЕРСТИЯ ПОД БОЛТ С ЦИЛИНДРИЧЕСКОЙ ГОЛОВКОЙ

РАЗМЕРЫ ЗЕНКОВАНИЯ ПОД ВИНТ С ГОЛОВКОЙ И БОЛТОВОГО ОТВЕРСТИЯ

Единицы: мм

Номинальный размер резьбы d	M3	M4	M5	M6	M8	M10	M12	M14	M16	M18	M20	M22	M24	M27	M30
d₁	3	4	5	6	8	10	12	14	16	18	20	22	24	27	30
d'	3.4	4.5	5.5	6.6	9	11	14	16	18	20	22	24	26	30	33
D	5.5	7	8.5	10	13	16	18	21	24	27	30	33	36	40	45
D'	6.5	8	9.5	11	14	17.5	20	23	26	29	32	35	39	43	48
H	3	4	5	6	8	10	12	14	16	18	20	22	24	27	30
H'	2.7	3.6	4.6	5.5	7.4	9.2	11	12.8	14.5	16.5	18.5	20.5	22.5	25	28
H''	3.3	4.4	5.4	6.5	8.6	10.8	13	15.2	17.5	19.5	21.5	23.5	25.5	29	32

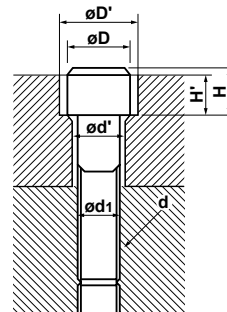
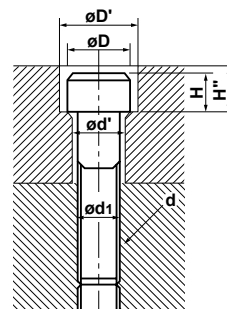

Р

ТЕХНИЧЕСКИЕ ДАННЫЕ

МЕЖДУНАРОДНАЯ СИСТЕМА ЕДИНИЦ

■ ЕДИНИЦЫ ИЗМЕРЕНИЯ ДЛЯ ПРОСТОГО ПРЕОБРАЗОВАНИЯ В ТАБЛИЦУ ЕДИНИЦ SI (Жирный шрифт указывает единицу измерения SI)

● Давление

Па	кПа	МПа	Бар	кгс/см ²	атм.	мм вод. ст.	мм рт. ст. или Torr
1	1×10 ⁻³	1×10 ⁻⁶	1×10 ⁻⁵	1.01972×10 ⁻⁵	9.86923×10 ⁻⁶	1.01972×10 ⁻¹	7.50062×10 ⁻³
1×10 ³	1	1×10 ⁻³	1×10 ⁻²	1.01972×10 ⁻²	9.86923×10 ⁻³	1.01972×10 ²	7.50062
1×10 ⁶	1×10 ³	1	1×10	1.01972×10	9.86923	1.01972×10 ⁵	7.50062×10 ³
1×10 ⁵	1×10 ²	1×10 ⁻¹	1	1.01972	9.86923×10 ⁻¹	1.01972×10 ⁴	7.50062×10 ²
9.80665×10 ⁴	9.80665×10	9.80665×10 ⁻²	9.80665×10 ⁻¹	1	9.67841×10 ⁻¹	1×10 ⁴	7.35559×10 ²
1.01325×10 ⁵	1.01325×10 ²	1.01325×10 ⁻¹	1.01325	1.03323	1	1.03323×10 ⁴	7.60000×10 ²
9.80665	9.80665×10 ⁻³	9.80665×10 ⁻⁶	9.80665×10 ⁻⁵	1×10 ⁻⁴	9.67841×10 ⁻⁵	1	7.35559×10 ⁻²
1.33322×10 ²	1.33322×10 ⁻¹	1.33322×10 ⁻⁴	1.33322×10 ⁻³	1.35951×10 ⁻³	1.31579×10 ⁻³	1.35951×10	1

Примечание 1) 1МПа=1Н/мм²

● Сила

Н	дина	кгс
1	1×10 ⁵	1.01972×10 ⁻¹
1×10 ⁻⁵	1	1.01972×10 ⁻⁶
9.80665	9.80665×10 ⁵	1

● Давление

Па	МПа или Н/мм ²	кгс/мм ²	кгс/см ²
1	1×10 ⁻⁶	1.01972×10 ⁻⁷	1.01972×10 ⁻⁵
1×10 ⁶	1	1.01972×10 ⁻¹	1.01972×10
9.80665×10 ⁶	9.80665	1	1×10 ²
9.80665×10 ⁴	9.80665×10 ⁻²	1×10 ⁻²	1

Примечание 1) 1МПа=1Н/мм²

● Работа / энергия / количество теплоты

Дж	кВт•ч	кгс•м	ккал
1	2.77778×10 ⁻⁷	1.01972×10 ⁻¹	2.38889×10 ⁻⁴
3.600 ×10 ⁶	1	3.67098×10 ⁵	8.6000 ×10 ²
9.80665	2.72407×10 ⁻⁶	1	2.34270×10 ⁻³
4.18605×10 ³	1.16279×10 ⁻³	4.26858×10 ²	1

Примечание 1) 1Дж=1Вт•с, 1Дж = 1Н•м
1ккал=4.18605Дж
(По закону мер и весо)

● Мощность (показатель производительности / потребляемая мощность) / количество теплоты

Вт	кгс•м/с	л.с.	ккал/ч
1	1.01972×10 ⁻¹	1.35962×10 ⁻³	8.6000 ×10 ⁻¹
9.80665	1	1.33333×10 ⁻²	8.43371
7.355 ×10 ²	7.5 ×10	1	6.32529×10 ²
1.16279	1.18572×10 ⁻¹	1.58095×10 ⁻³	1

Примечание 1) 1Вт=1Дж, л.с. - лошадиная сила
1л.с.=0.7355кВт
1ккал=4.18605Дж
(По закону мер и весов)

ПРЕДМЕТНЫЙ УКАЗАТЕЛЬ

ПРЕДМЕТНЫЙ УКАЗАТЕЛЬ ПО ОБОЗНАЧЕНИЮ ИНСТРУМЕНТА

A.....	2
B.....	2
C.....	2
D.....	2
E.....	2
F.....	2
G.....	2
H.....	2
J.....	2
K.....	2
L.....	2
M.....	3
N.....	3
P.....	3
R.....	3
S.....	3
T.....	4
U.....	4
V.....	4
W.....	4



ПРЕДМЕТНЫЙ УКАЗАТЕЛЬ ПО ОБОЗНАЧЕНИЮ ИНСТРУМЕНТА

Обозначение	Наименование продукции	Страница	Обозначение	Наименование продукции	Страница
A			G		
AJS○○○○○T○○	Крепежный винт	N003	GY05016S	Крепежный винт	N004
AMS○	Прихват	N015	GY06013M	Крепежный винт	N004
B			H		
BCP○○○	Штифт опорной пластины	N014	HBH○○○○○	Крепежный винт	N002
BOES101	Установочный болт	N009	HBHA○○○○○	Крепежный винт	N002
BPT322	Опорная пластина	N011	HDS○○○○○	Установочный болт	N009
BRS○○○	Крепежный винт	N003	HFF06015	Крепежный винт	N004
C			HFF080○○H	Установочный болт	N009
CA○○○	Прихват	N015	HKY○○D	Отвертка	N002
CAS51T	Установочный винт	N003	HKY○○F	Флажковый ключ	N002
CBS○	Элемент стружколома	N017	HKY○○L	L-образный ключ	N002
CBS○○	Элемент стружколома	N017	HKY○○R	L-образный ключ	N002
CBT○	Элемент стружколома	N017	HKY○○T	T-образный ключ	N002
CBT○○	Элемент стружколома	N017	HKY○○W	Флажковый ключ	N002
CBT○○○○	Элемент стружколома	N017	HS○○	Крепежный винт	N004
CCK○○	Прихват	N015	HSC○○○○○	Крепежный винт	N002, N009
CCP○○	Штифт опорной пластины	N014	HSC○○○○○H	Установочный болт	N009
CCTC1	Прихват	N015	HSCX○○○○○H	Установочный болт	N009
CK○○○	Прихват	N015	HSP05008C	Запирающий винт	N004
CKW6	Прихват	N016	HSS○○○○○	Крепежный винт	N002
CS○○	Опорная пластина	N011	HY○	Втулка винтовая	N004
CSF401260T	Крепежный винт	N003	HY-A1	Втулка винтовая	N004
CS○○○T	Крепежный винт	N003	HY-V1	Втулка винтовая	N004
CS○○○○○T	Крепежный винт	N003	J		
CS○○○○○○○T	Крепежный винт	N003	JFS-○	“Обозначение комплекта ТОЧНЫХ ПЕРЕХОДНЫХ ВТУЛОК”	M172
CS○○○○○○○TS	Крепежный винт	N003	JFS○○○○○-○	ТОЧНАЯ ПЕРЕХОДНАЯ ВТУЛКА (ТПВ)	M172
CT○○	Опорная пластина	N011	JSS○	Прижимной винт	N004
CT32T1	Опорная пластина	N012	K		
D			L		
DCK○○○○	Прихват	N016	LK1	Прихват	N016
DCSVN32	Опорная пластина	N011	LLCL○○○	Зажимной рычаг	N014
DC○○○○○T	Крепежный винт	N003	LLCL○○S	Зажимной рычаг	N014
DKS○	Крепежный винт	N003	LLCS○○○	Крепежный винт	N005
DLE○○○○S○○○P○○○	Направляющее сверло типа DLE .M012, M013		LLCS○○○○S	Крепежный винт	N005
DSAS○○○○X○○S○○○	Сверло типа DSAS	M096—M098	LLP○○	Штифт опорной пластины	N014
DWAE○○○○X○○S○○○	Сверло типа MINI-DWAE	M020			
DWAE○○○○X○○S○○○	Сверло типа DWAE	M021—M026			
E					
EGS○○○○○	Крепежный винт	N004			
ESS42	Опорная пластина	N011			
EST○○	Опорная пластина	N011			
F					
FC400890T	Крепежный винт	N004			

Обозначение	Наименование продукции	Страница	Обозначение	Наименование продукции	Страница
LLR	Радиальный винт	N004	MNS	Сверло типа MNS	M100–M117
LLSCN	Опорная пластина	N011	MNS	Сверло типа MNS	M100–M117
LLSCN	Опорная пластина	N011	MNS	Сверло типа MNS DIN6537	M100–M119
LLSCP	Опорная пластина	N011		(Хвостовик с лыской)	M100–M119
LLSDN	Опорная пластина	N011	MNS	Сверло типа MNS DIN6537	M100–M119
LLSDP42	Опорная пластина	N011		(Цилиндрический хвостовик)	M100–M119
LLSRN	Опорная пластина	N011	MP6	Штифт опорной пластины	N014
LLSSN	Опорная пластина	N011	MPS	Сверло типа MPS	M062–M072
LLSSP42	Опорная пластина	N011	MPS	Сверло типа MPS	M062–M073
LLSTE32	Опорная пластина	N012	MPS1	Сверло типа MPS1	M044–M058
LLSTN	Опорная пластина	N012	MPS1	Сверло типа MPS1	M044–M058
LLSTP	Опорная пластина	N012		(Хвостовик с лыской)	M044–M058
LLSWN	Опорная пластина	N012	MPS1	Сверло типа MPS1 DIN6537	M044–M058
LLSWN	Опорная пластина	N012		(Цилиндрический хвостовик)	M044–M058
LLSWP	Опорная пластина	N012	MSCN63	Опорная пластина	N012
LS	Крепежный винт	N005	MSE	Сверло типа MSE	M008, M009
LS	Крепежный винт	N005	MSL	Сверло типа MSL	M074–M076
LS	Крепежный винт	N005	MSP0300SB	Сверло типа MSP	M011
LS	Крепежный винт	N005	MSSN63	Опорная пластина	N012
LS10TS	Крепежный винт	N005	MTK	Прихват	N016
LS24H	Крепежный винт	N005	MVS	Сверло типа MINI-MVS	M036, M037
M			MVX	Сверло типа MVX	M160–M167
MAE	Сверло типа MAE	M124–M128	MWS	Сверло типа MINI-MWS	M040, M041
	(Наружное охлаждение)		N		
MAS	Сверло типа MAS	M124–M128	NS	Крепежный винт	N006
	(Внутреннее охлаждение)		NS	Крепежный винт	N006
MBA	Крепежный винт	N009	P		
MCA	Сверло типа MCA	M189	P	Запирающий штифт	N015
MCAH	Сверло типа MCAH	M193	PS	Опорная пластина	N011
MCC	Сверло типа MCC	M188	PT	Опорная пластина	N011
MCCH	Сверло типа MCCH	M192	PT	Опорная пластина	N012
MCT	Сверло типа MCT	M190	P	Запирающий штифт	N015
MCW	Сверло типа MCW	M191	PV	Опорная пластина	N013
MFE	Сверло типа MINI-MFE	M018	P	Запирающий штифт	N015
MGS6	Прижимной винт	N005	P	Запирающий штифт	N015
MGS	Сверло типа MICRO-MGS	M079	P	Запирающий штифт	N015
MHK5NR/L	Прихват	N016	R		
MHS	Сверло типа MHS	M130–M137	RKY	Ключ	N002
MHS	Опорная пластина	N012	RN-S	Крепежный винт	N006
MHT1	Крепежный винт	N005	RS	Крепежный винт	N006
MK1K	Противозадирная смазка	N018	S		
MK1KS	Противозадирная смазка	N018	S	Крепежный винт	N006
MLCP42	Опорная пластина	N012	SD	Установочный болт	N006
MLDP42	Опорная пластина	N012	SETK	Прихват	N016
MLSP42	Опорная пластина	N012	SETS	Крепежный винт	N006
MLTP32	Опорная пластина	N012			
MMS	Сверло типа MMS	M082–M093			
MMS	Сверло типа MMS	M082–M093			
MMS	Сверло типа MMS	M082–M093			

ПРЕДМЕТНЫЙ УКАЗАТЕЛЬ ПО ОБОЗНАЧЕНИЮ ИНСТРУМЕНТА

Обозначение	Наименование продукции	Страница	Обозначение	Наименование продукции	Страница
SLCS	Крепежный винт	N006	W		
SOMX	Пластина (Для сверла типа MVX)	M168	WCS	Винт опорной пластины	N008
SPSVN32	Подкладная пластина	N013	WPSTN	Опорная пластина	N013
SPS1	Винт локатора	N006	WPSWC43	Опорная пластина	N013
SRK1R	Прихват	N016	WPSWN43	Опорная пластина	N013
SRS5	Крепежный винт	N006	WPT4405	Очиститель (Для сверла типа TAW)	M150–M154
STASX	Опорная пластина	N013	WS	Крепежный винт	N008
STAWN	Сверло типа STAW	M141–M143	WS	Крепежный винт	N008
STAWN	Пластина (Для сверла типа STAW)	M145			
STAWN	Пластина (Для сверла типа STAW)	M144, M145			
STAW	Сверло типа STAW	M141–M143			
STBS500N	Опорная пластина	N013			
STS1	Винт опорной пластины	N006			
T					
TAWN	Пластина (Для сверла типа TAW)	M155, M156			
TAWN	Сверло типа TAW (Общее применение)	M150–M154			
TIP	Ключ	N002			
TKY	Отвертка	N002			
TKY	Флажковый ключ	N002			
TKY	Длинный ключ	N002			
TKY	L-образный ключ	N002			
TKY	T-образный ключ	N002			
TKY	Флажковый ключ	N002			
TPS	Крепежный винт	N008			
TPS	Крепежный винт	N008			
TPS	Крепежный винт	N008			
TPS	Крепежный винт	N008			
TPS-1	Крепежный винт	N008			
Ts	Крепежный винт	N007			
Ts	Крепежный винт	N007			
Ts	Крепежный винт	N007			
Ts	Крепежный винт	N007			
TSR	Крепежный винт	N008			
TSS	Радиальный винт	N008			
TSS	Крепежный винт	N008			
U					
UCR	Прихват	N016			
V					
VAPDM	Сверла VIOLET	M179–M181			
VAPDS	Сверла VIOLET	M174–M177			
VAPDSCB	Сверла VIOLET	M185, M186			
VSD	Сверла VIOLET, Прямой хвостовик	M183, M184			

GERMANY

MMC HARTMETALL GMBH
Comeniusstr. 2 . 40670 Meerbusch
Phone +49 2159 91890 . Fax +49 2159 918966
Email admin@mmchg.de

U.K.

MMC HARDMETAL U.K. LTD.
Mitsubishi House . Galena Close . Tamworth . Staffs. B77 4AS
Phone +44 1827 312312 . Fax +44 1827 312314
Email sales@mitsubishicarbide.co.uk

SPAIN

MITSUBISHI MATERIALS ESPAÑA, S.A.
Calle Emperador 2 . 46136 Museros/Valencia
Phone +34 96 1441711 . Fax +34 96 1443786
Email comercial@mmevalencia.es

FRANCE

MMC METAL FRANCE S.A.R.L.
6, Rue Jacques Monod . 91400 Orsay
Phone +33 1 69 35 53 53 . Fax +33 1 69 35 53 50
Email mmfsales@mmc-metal-france.fr

POLAND

MMC HARDMETAL POLAND SP. Z O.O
Al. Armii Krajowej 61 . 50 - 541 Wrocław
Phone +48 71335 1620 . Fax +48 71335 1621
Email sales@mitsubishicarbide.com.pl

RUSSIA

MMC HARDMETAL OOO LTD.
Electrozavodskaya St. 24 . build. 3 . Moscow . 107023
Phone +7 495 725 58 85 . Fax +7 495 981 39 79
Email info@mmc-carbide.ru

ITALY

MMC ITALIA S.R.L.
Viale Certosa 144 . 20156 Milano
Phone +39 0293 77031 . Fax +39 0293 589093
Email info@mmc-italia.it

TURKEY

MMC HARTMETALL GMBH ALMANYA - İZMİR MERKEZ ŞUBESİ
Adalet Mahallesi Anadolu Caddesi No: 41-1 . 15001 35580 Bayraklı/İzmir
Phone +90 232 5015000 . Fax +90 232 5015007
Email info@mmchg.com.tr

www.mitsubishicarbide.com | www.mmc-hardmetal.com